

# AP 240

PNEU TYRED ROLLER  
CUMMINS QSB3.3-C99  
EU Stage IIIA / U.S. EPA Tier 3

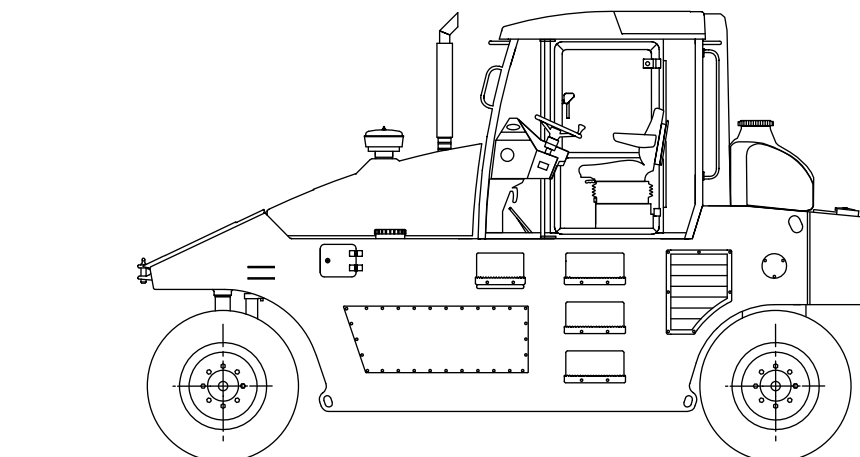

## WORKSHOP MANUAL

EDITION 10/2021 EN  
Product Identification Number 3015688 -

**AMMANN**

CLICK HERE TO **DOWNLOAD** THE COMPLETE MANUAL

- Thank you very much for reading the preview of the manual.
- You can download the complete manual from: [www.heydownloads.com](http://www.heydownloads.com) by clicking the link below



- Please note: If there is no response to CLICKING the link, please download this PDF first and then click on it.

CLICK HERE TO **DOWNLOAD** THE COMPLETE MANUAL

## **2. Safety precautions and instructions**

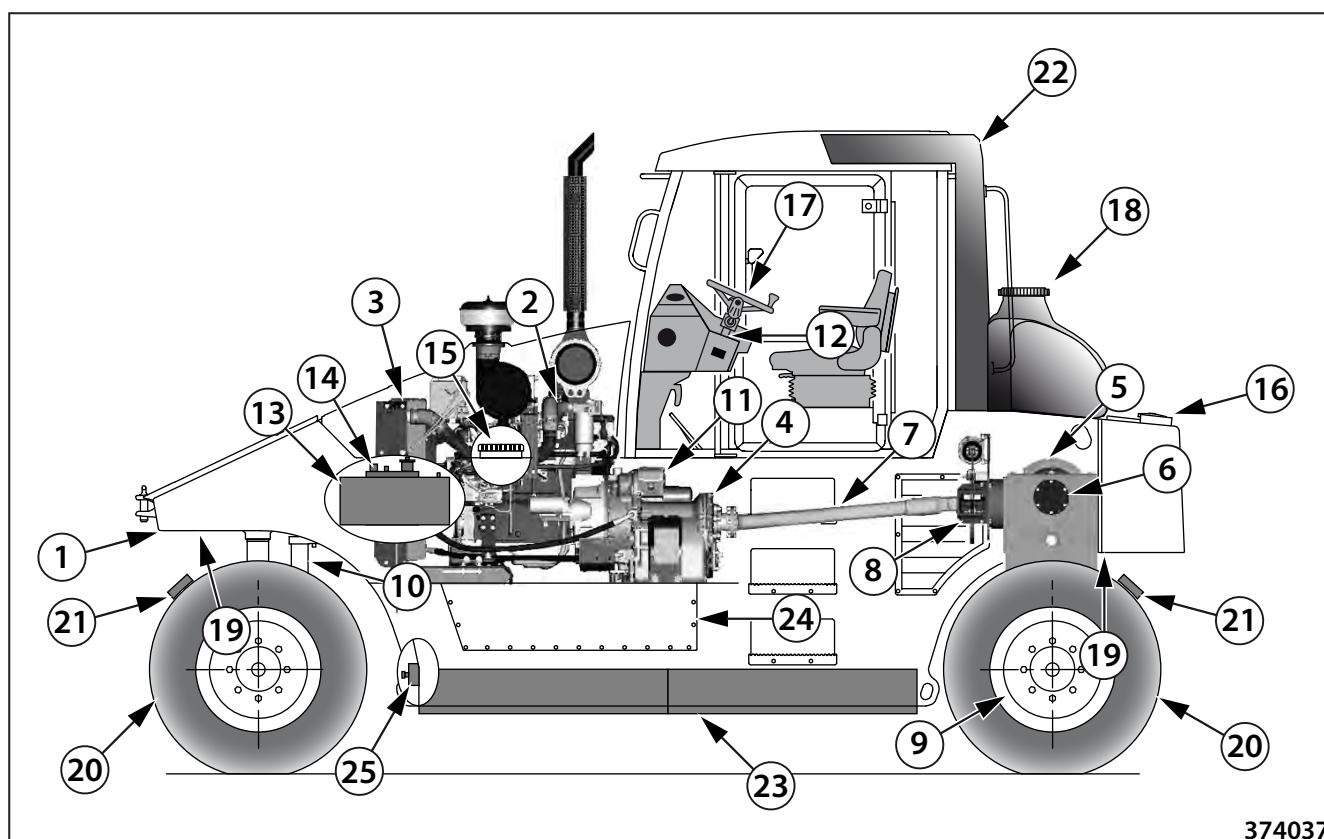

374037

- |  |                                       |
|--|---------------------------------------|
| 1 - Roller Frame   | 15 - Additional Water Weight Closure* |
| 2 - Engine   | 16 - Fuel Tank                        |
| 3 - Engine Radiator + Hydraulic Circuit Cooler<br>+ Gearbox Cooler | 17 - Driver's Control Stand           |
| 4 - Gearbox incl. Torque Converter                                 | 18 - Sprinkling Tank                  |
| 5 - Final Drive Housing incl. Differential                         | 19 - Tire Sprinkling                  |
| 6 - Speed Reduction Transmissions                                  | 20 - Wheels                           |
| 7 - Propeller Shaft  | 21 - Scrapers                         |
| 8 - Parking and Emergency Brake                                    | 22 - Protective ROPS Frame            |
| 9 - Driving Brakes (rear wheels only)                              | 23 - Additional Weight                |
| 10 - Front Axle incl. Telescopic Cylinders                         | 24 - Ballast Space Lids               |
| 11 - Pump for Compressor Drive                                     | 25 - Additional Water Weight Drain *  |
| 12 - Power Assisted Steering                                       |                                       |
| 13 - Battery (cylinder's LH side)                                  |                                       |
| 14 - Hydraulic Tank (cylinder's RH side)                           |                                       |

\* - If waterproof frame for additional weight incl. water medium is used with the Machine, then please refer to Specification Manual - "The Weights".

<b>AP 240</b>		
<b>EU Stage IIIA / U.S. EPA Tier 3</b>		
<b>Noise and vibration emissions</b>		
Measured sound power level A, $L_{pA}$ at the operator's position (cab) *	dB	81
Uncertainty $K_{pA}$ *	dB	2
Guaranteed sound power level A, $L_{WA}$ **	dB	101
Declared highest weighted effective value of vibration acceleration transmitted to the whole body (cab) ***	$m/s^2$ (ft/s <sup>2</sup> )	<0.5 (<1.6)
Declared total value of vibration acceleration transmitted to hands (cab) ***	$m/s^2$ (ft/s <sup>2</sup> )	<2.5 (<8.2)
* measured according the EN 500-4		
** measured according the DIRECTIVE 2000/14/EC		
*** measured according the EN 1032+A1 on the gravel base under the vibration travel)		

<b>Optional equipment</b>
<p>Cab with ventilation and heating</p> <p>ROPS protection*</p> <p>ROPS canopy (mounted to ROPS)</p> <p>Cab FOPS protection (mounted to ROPS)</p> <p>Air conditioning</p> <p>Radio preparation (box, 2 repro, antenna) (cab version only)</p> <p>Radio, CD, MP3 (cab version only)</p> <p>Waterproofed Frame</p> <p>Towing hinge front</p> <p>Thermal aprons</p> <p>Edge cutter</p> <p>Ammann Traction System / Diff lock</p> <p>4 + 4 tyres MITAS radial instead of standard ones</p> <p>4 + 4 tyres Dunlop radial instead of standard ones</p> <p>4 + 4 tyres Michelin radial instead of standard ones</p> <p>Spare part wheel with smooth diagonal tyre</p> <p>Ballast 2.800 kg - Concrete</p> <p>Ballast 6.000 kg - Steel</p> <p>Ballast (metal into frame) per 1 ton</p> <p>Fan safety screen</p> <p>Warning beacon (rotating warning light)</p> <p>Back-up alarm</p> <p>Chock blocs</p> <p>Mirror for front wheel</p> <p>Cocoa scrapers instead of standard ones</p> <p>Special colour ral up to 2 colors</p> <p>Special paint schema</p> <p>Fire extinguisher</p> <p>First service kit for the first 500 h (engine filters, air filters)</p> <p>Toolkit</p> <p>Wheel spanner</p> <p>Engine pre-filter</p> <p>Set of documentation - printed hardcopy</p> <p>* Compulsory equipment for CE</p>

## 6. Lubrication and Maintenance Chart

## 7.2. Engine removal



Carry out preparation work and removal and reinstallation itself in line with the initial section called "Safety Precautions and Instructions". Adhere to eco measures and hygienic principles.

### Following operations are required to remove the engine:

- Put the Machine in horizontal position, on paved surface.
- Secure front wheels from both sides with wooden Scotch blocks.
- Turn OFF storage battery master switch – Machine will be automatically braked.
- Place warning board - "MACHINE OUT OF OPERATION".
- Drain media
  - Water tank
  - ROPS – Roll Over Protective Structure
  - Bonnet
  - Cabin
  - Front panel

### Media drained

Drain engine oil.



Drain cooling liquid.



Remove RH side hoses.

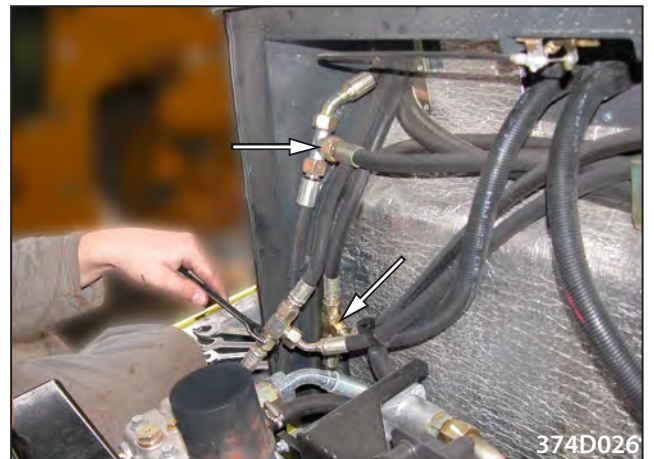

Remove hoses – LH side.

Note: Mark hose ends.



Remove instrument panel.



Fold up.

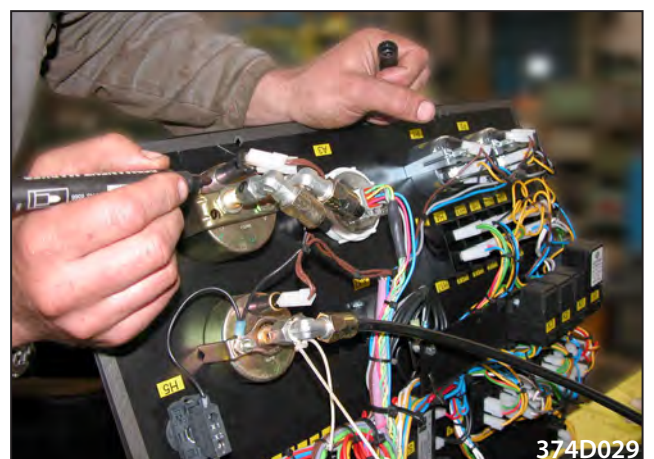

Remove fuel supply.



Remove fuel overflow from fuel injection pump.

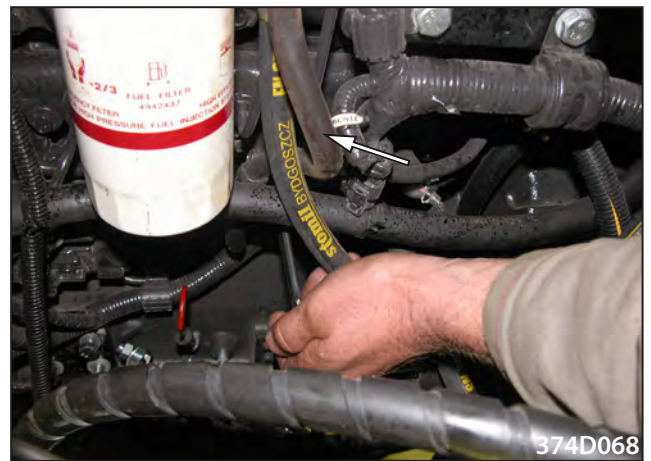

Remove hose pipe used to drain oil from gearbox.



Remove engine mounting in front.



## **8. How to replace radiators and cooler**

## 9.2. How to remove axle from the Machine



Carry out setup work and removal as well as reinstallation itself in line with the initial Section named "Safety Precautions and Instructions". Adhere to eco measures and hygienic principles.

### Carry out the following operations to remove the rear axle:

- Position Machine horizontally on paved area.
- Secure front wheels from both sides with wooden Scotch blocks.
- Turn Off master switch – Machine is braked automatically.
- Place warning board - "MACHINE OUT OF OPERATION".

### Removing the water tank

Remove the water tank fastening straps.



Lift the cover and remove the hose leading to sprinkling filter.



9.3. How to remove axle

141

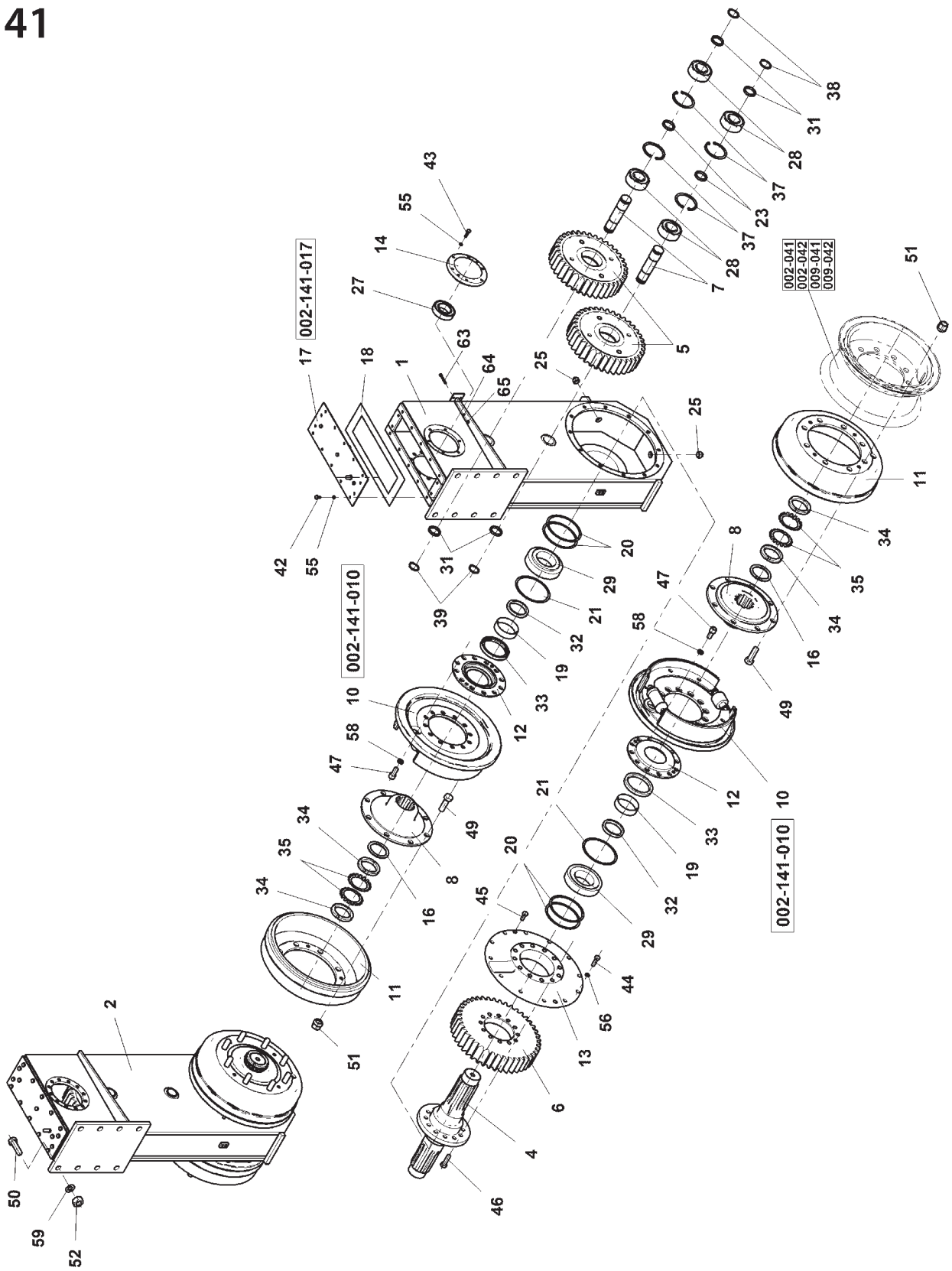

- Screw on lifting lug onto the shaft (4), and position the assembly unit into the outer ring of bearing (29) in cover (12).

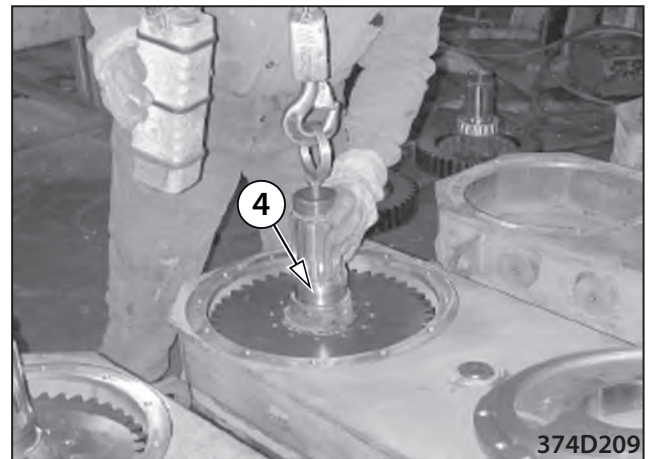

- Paint contact surface of cover (13) and of casing hole with caulking compound. Screw on lifting lugs of M12 thread into the forcing-off holes in cover (13), and position into the casing holes – the position of recess “a” according to Fig. – seal the bolting (44), (45) with LOCTITE caulking compound.

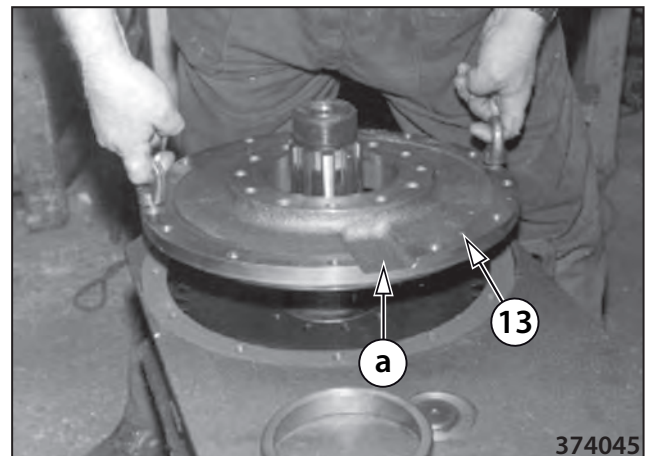

- Ram the outer ring of second bearing (29) into cover (13).

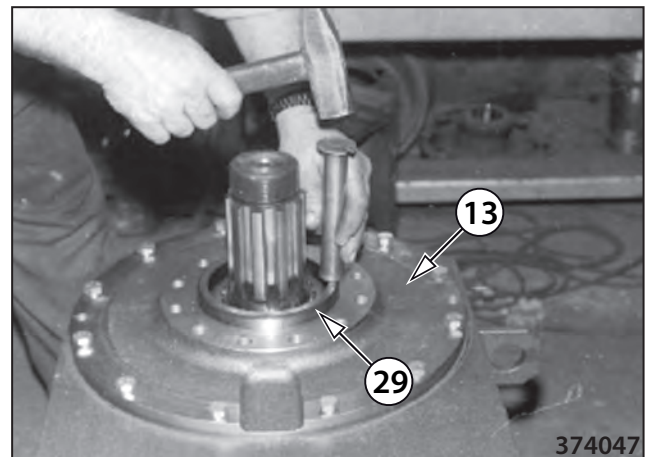

- Install cover (13) and then insert shims (20), (21) to adjust pre-tension of bearings (29). The size of bearing pre-tension =  $0.4 \div 0.6$  mm (0.016 - 0.024 in).

### How to determine pre-tension size:

- measure “X” – size of recess on cover (12) as per the Fig.

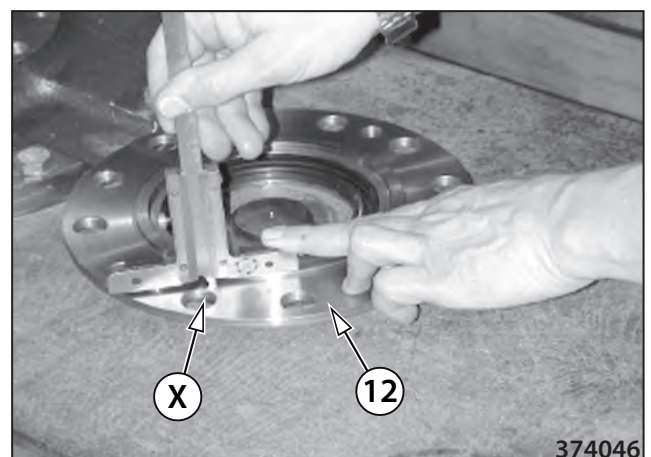

CLICK HERE TO **DOWNLOAD** THE COMPLETE MANUAL

- Thank you very much for reading the preview of the manual.
- You can download the complete manual from: [www.heydownloads.com](http://www.heydownloads.com) by clicking the link below



- Please note: If there is no response to CLICKING the link, please download this PDF first and then click on it.

CLICK HERE TO **DOWNLOAD** THE COMPLETE MANUAL

## 10.1. How to remove axle from the Machine



Carry out setup work and removal as well as reinstallation itself in line with the initial Section named "Safety Precautions and Instructions". Adhere to eco measures and hygienic principles.

### Carry out the following operations to remove front axle:

- Position the Machine horizontally on paved area.
- Secure rear wheels on both sides with wooden Scotch blocks.
- Turn Off master switch – Machine is braked automatically.
- Place warning board - "MACHINE OUT OF OPERATION. Release wheel nuts.
- Use Machine's lifting lugs to put proper rigging in, lift the Machine in its front as high as to have front wheels lifted above ground. Put proper supports under the Machine frame, see the Fig.

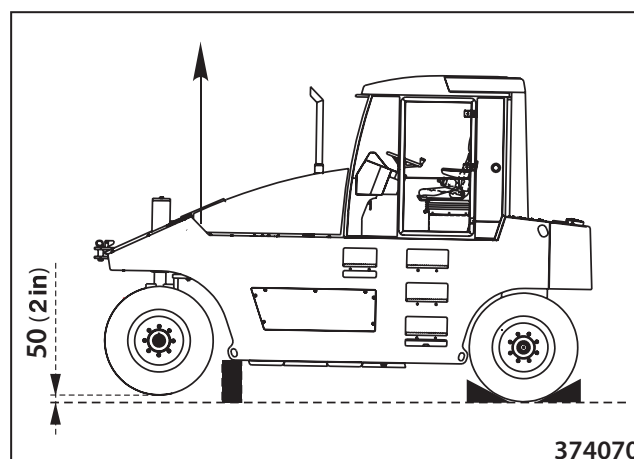

- Remove cover in the frame overhead the front wheels.



- Remove the pipe of levelling, incl. connecting pipe.

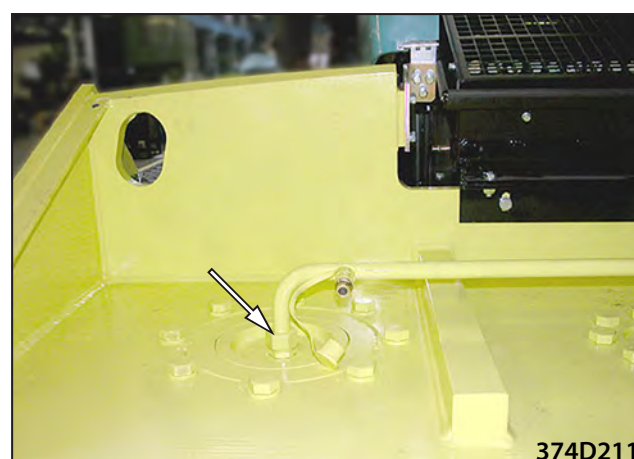

Fit lifting lug onto the shaft – fixture No. 5.

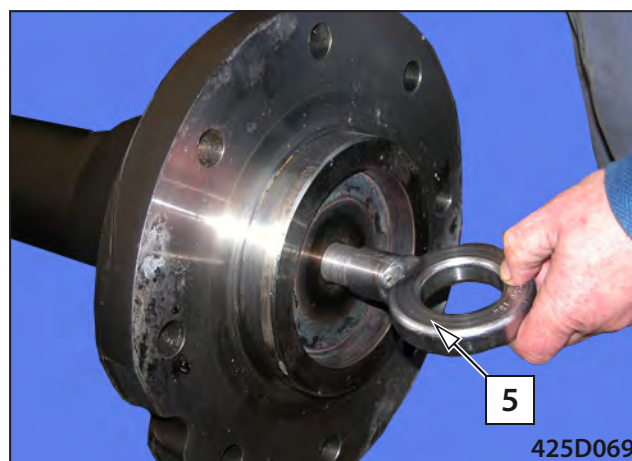

Hang on the crane, slide in the cylinder. Turn slightly the shaft when sliding in.



Check scraper ring (5) not to be folded.



Shift locking pin out.

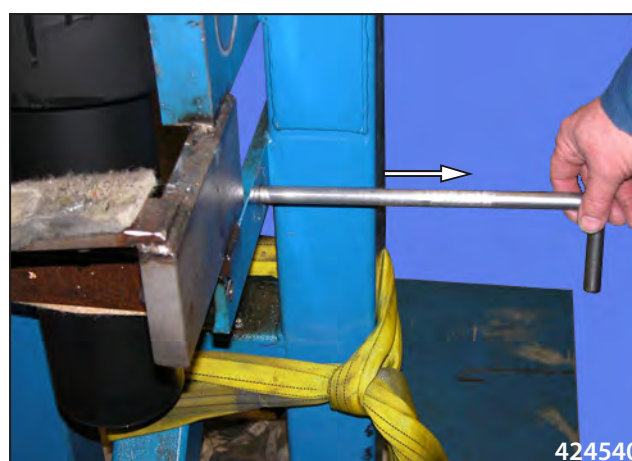

Insert the bearing inner ring (002-001-001-6) lubricated with grease.



Strike on the bearing outer ring (002-001-001-6) by means of jig No. 12.

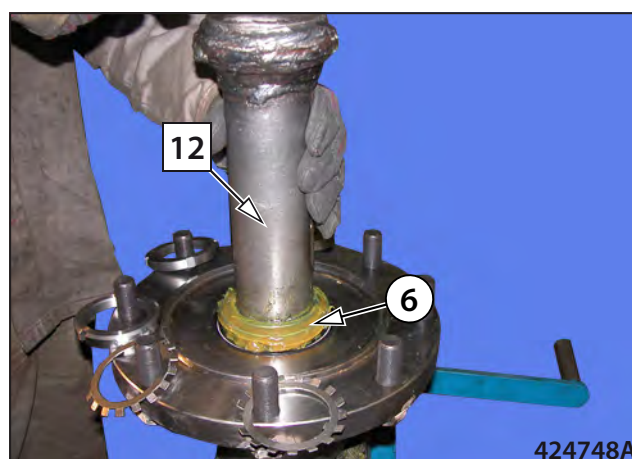

Mount the ring (002-001-001-4) by means of jig No. 13 - the jig protects the radial shaft seal lip against damage.

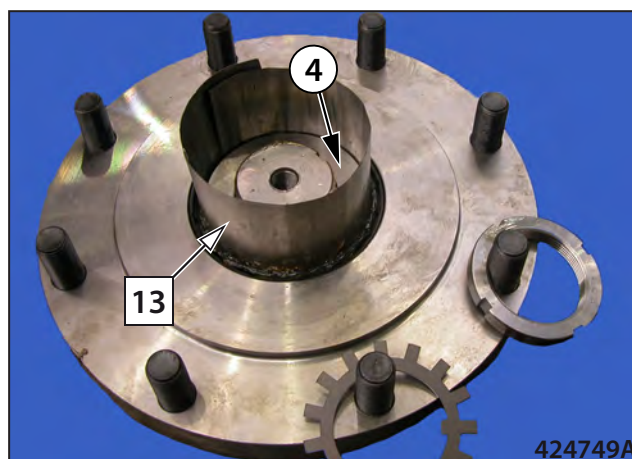

Mount the retaining ring (002-001-001-5).

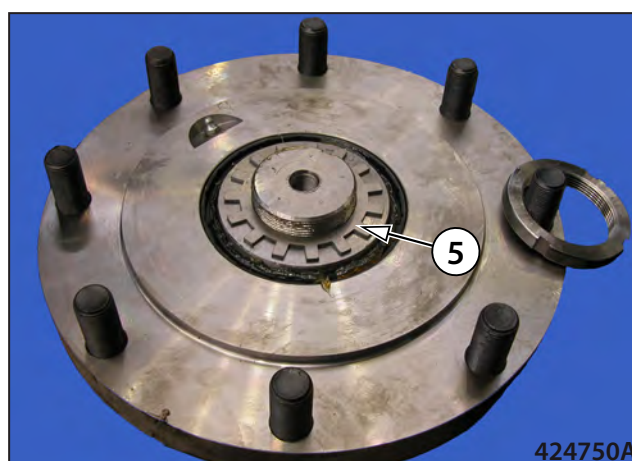

No. 11 Assembly stand (64-374-276)



No. 12 Pressing one (92-631-006) – for bearing 9 (ø 70 / ø 63-200)

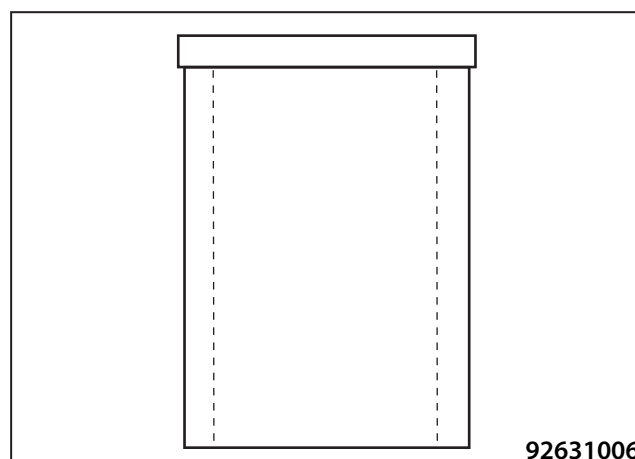

No. 13 Assembly one (64-374-0004) – for gufero seal ring

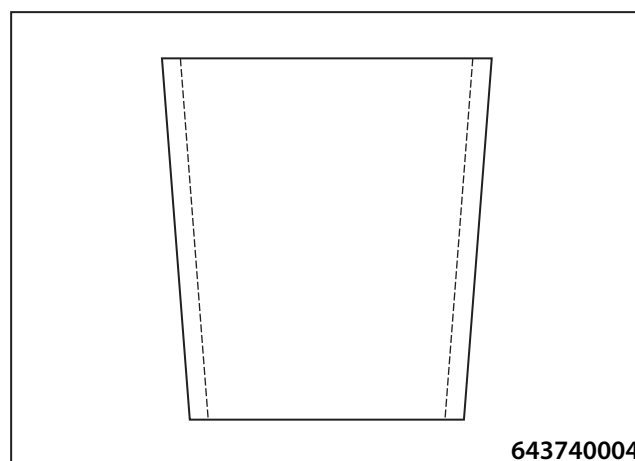

No. 14 Assembly one (64-373-0461) – adapter to screw down KM nuts

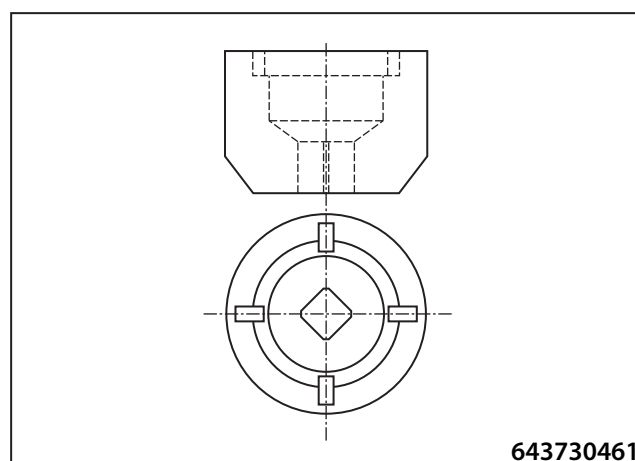

- Take out.

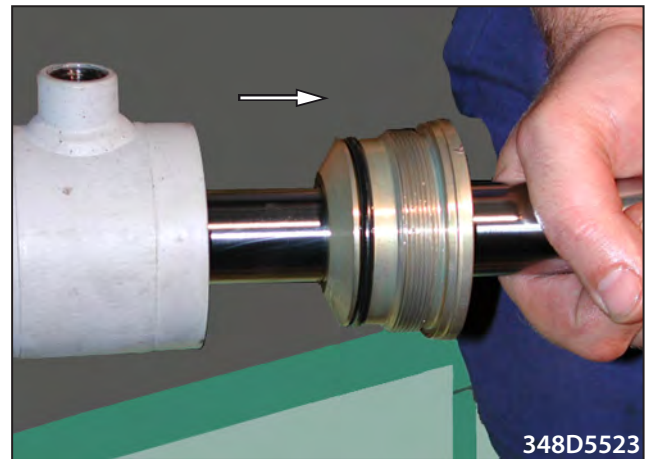

- Take out steering unit's piston



- Remove piston nut and reseal the piston together with cover.



- Mount fixture 3 into the body of steering unit.

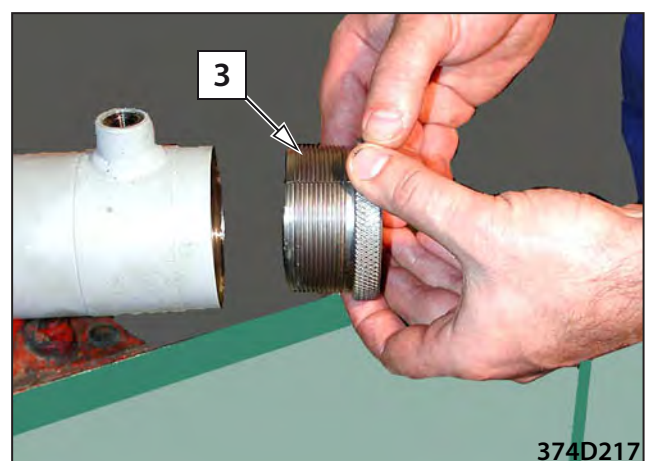

## How to remove pedal brake cylinder

Pull the chain of air tank's drain valve to let the pressure air out from air circuit of the Machine.



Remove floor cover sheet at Machine Operator's post.

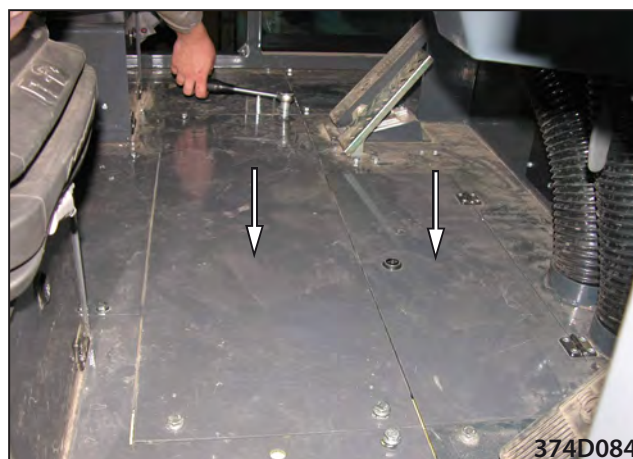

Lift the floor cover with pedals. Unscrew the connecting pipes from the brake master cylinder outlets on both sides.



Unscrew bolts 4x and take out the brake master cylinder.

## How to reinstall:

Proceed in reverse order of the removal.

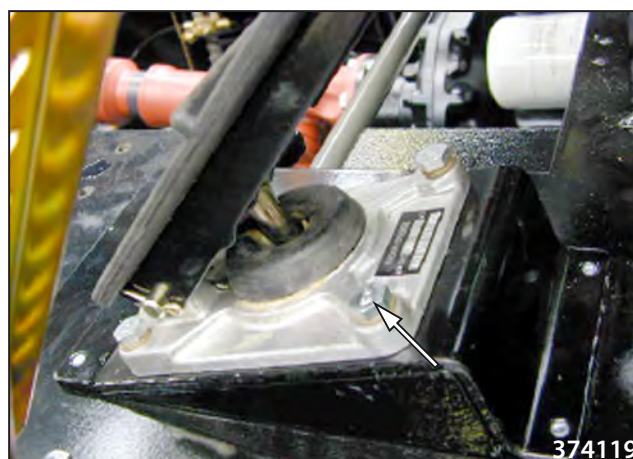

Remove cover (3) and lift off maintenance cover (4), lock in lift-off position.

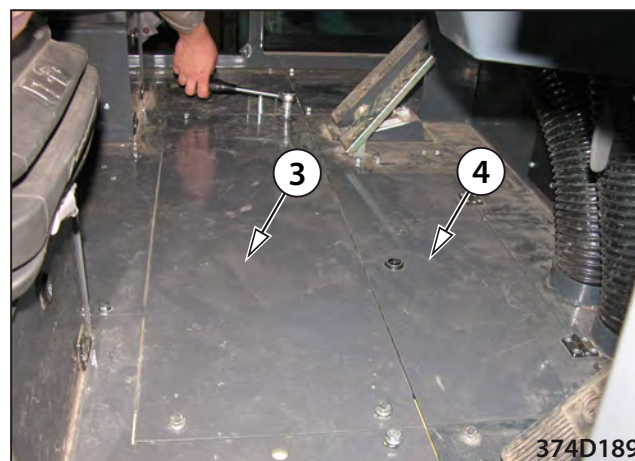

Remove bolts used to mount LH seat.

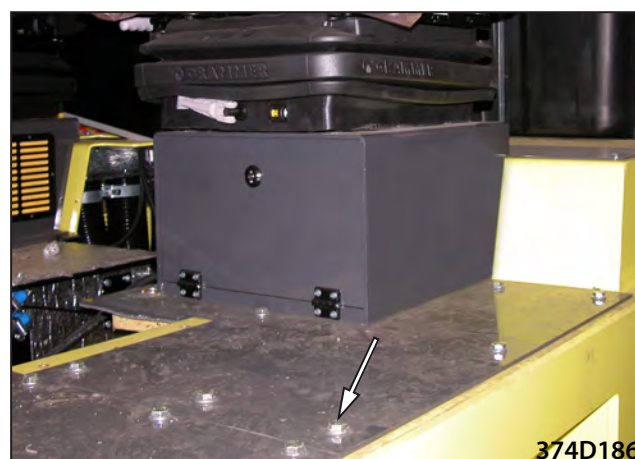

Slacken bolts along cabin perimeter, these bolts are used to mount cabin (7x) to the Machine frame.



Lift the cabin.



### 13.3. How to replace hydraulic tank

Drain hydraulic oil.



Remove cover.



Remove hydraulic hose pipes.

Disconnect wiring.

Remove hydraulic tank clamping.

Take out hydraulic tank.

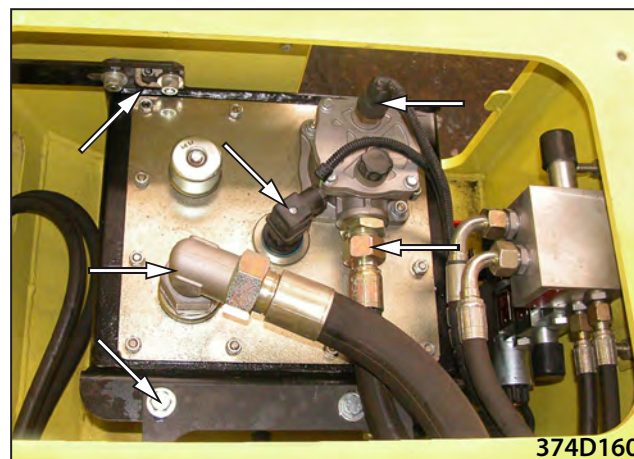

## 14. Wiring

Mount the side cover.

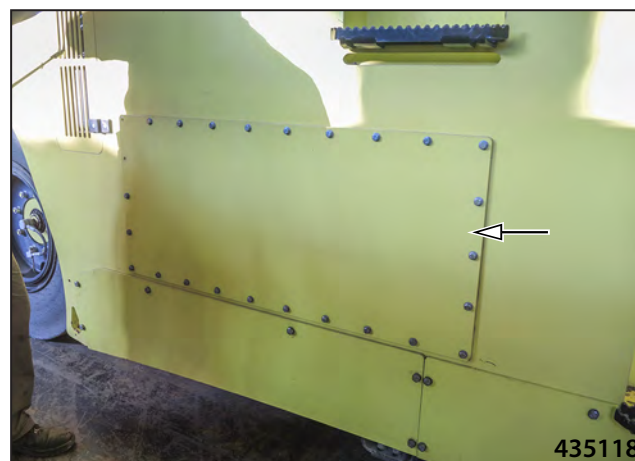

Fill the frame with water through the filler neck.

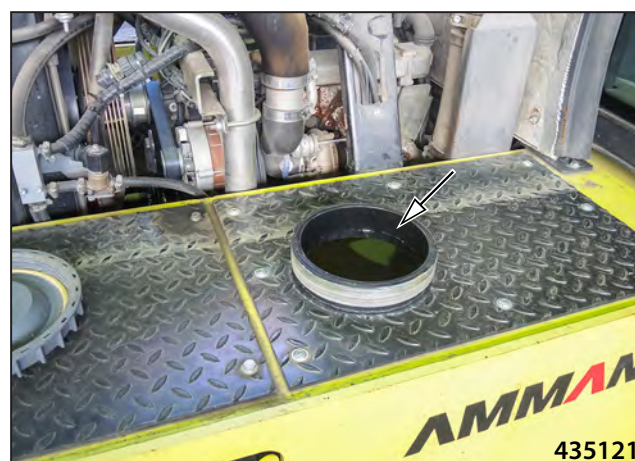

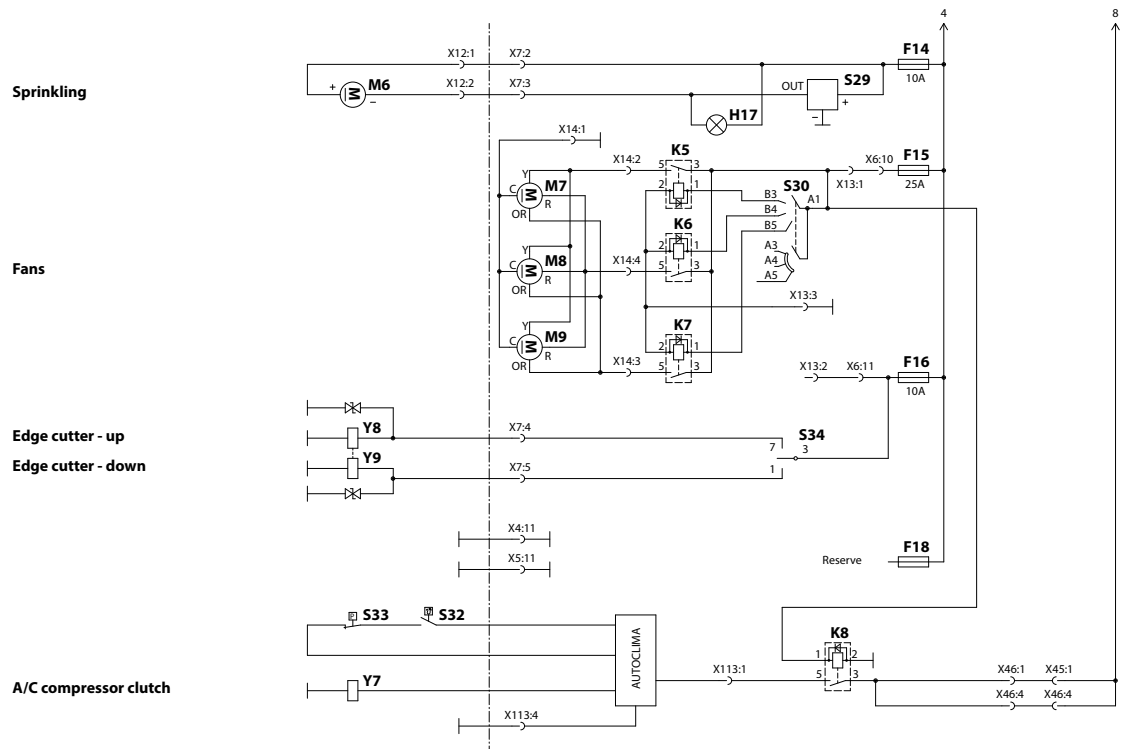

**AP240 Tier 3**  
**CABLE HARNESS #1, part 1**  
**Objektová část 24-22-0240**

**2.1**

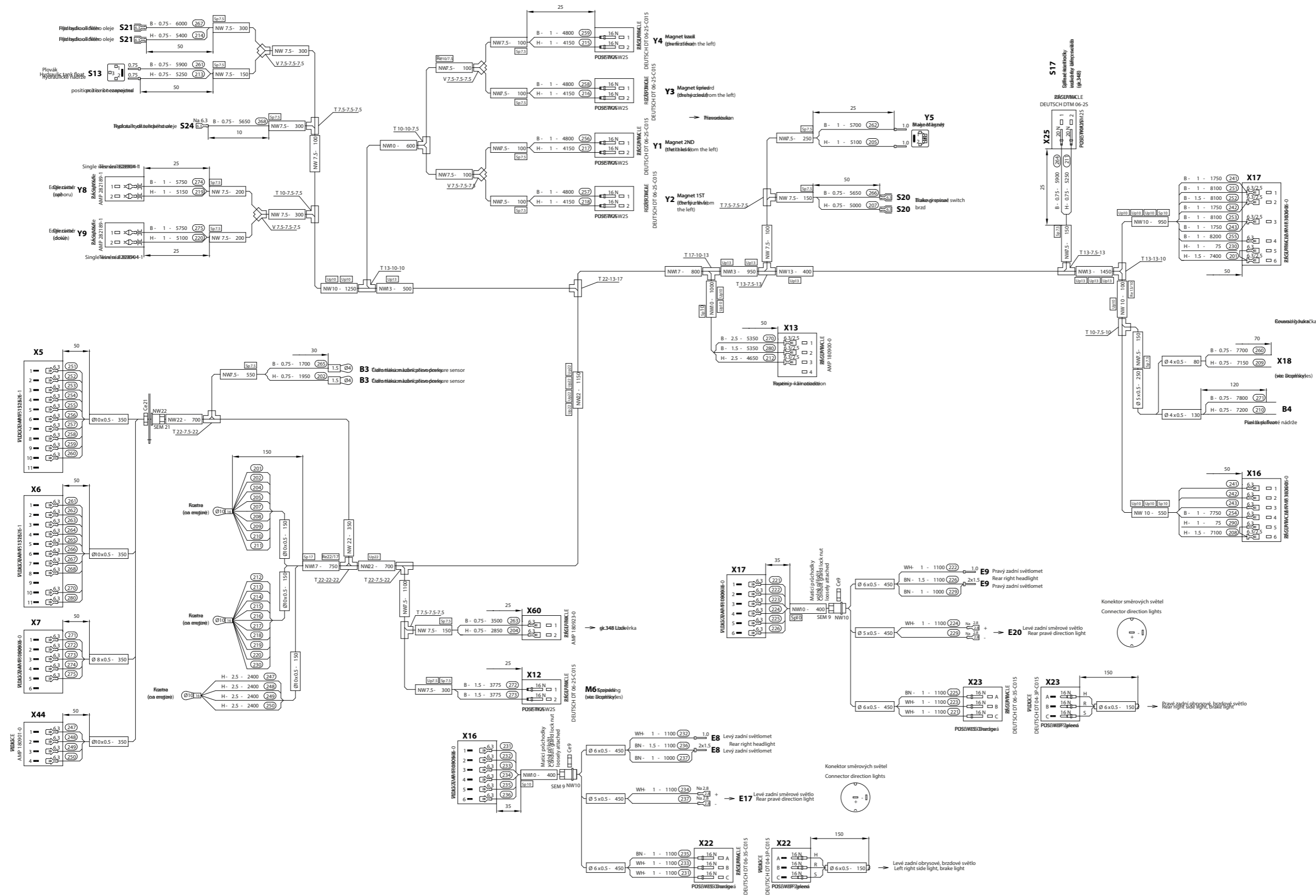

**CABLE HARNESS LEGEND:**



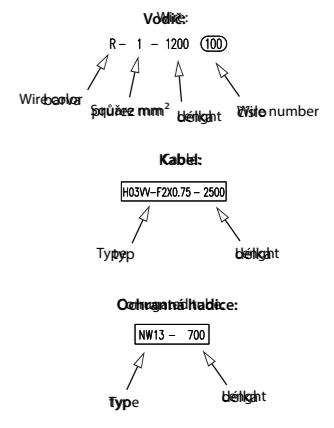















- Fastom
- Ringlock
- Diode
- Diode with arrow
- Contact
- Plug
- Wire seal
- Seal
- Matcut
- Sleeve
- Slit
- Reducer
- Pin
- Connector
- SEM straight
- Factor
- Diode with arrow
- Diode with arrow
- Connector
- Connector



**TABLE OF COLORS/SYMBOLS:**

WH	B	Bílá
BK	C	Černá
BN	H	Červená
BU	M	Modrá
RD	R	Redá
GY	S	Šedá
YE	Y	Žlutá
GN	Z	Zelená

CABLE HARNESS LEGEND:

-  Faston
  -  Ring terminal
  -  Distributor
  -  Split cable
  -  Contact
  -  Solder plug
  -  Wire seal
  -  Cable
  -  Isolation sleeve
  -  Clamp
  -  Reducer
  -  Clamp
  -  Terminal block
  -  SEM straight
  -  Fastener
  -  Bracket
  -  Bibber
  -  Nestacle connector
  -  Plug connector
- Válite:**
- Wirbelvor R - 1 - 1200 (100) **W**ite number
- Kabel:**
- H03VV-F2X0.75 - 2500 **T**ype **L**enght
- Ochranná hadice:**
- NW13 - 700 **T**ype **L**enght

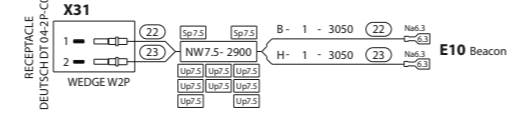
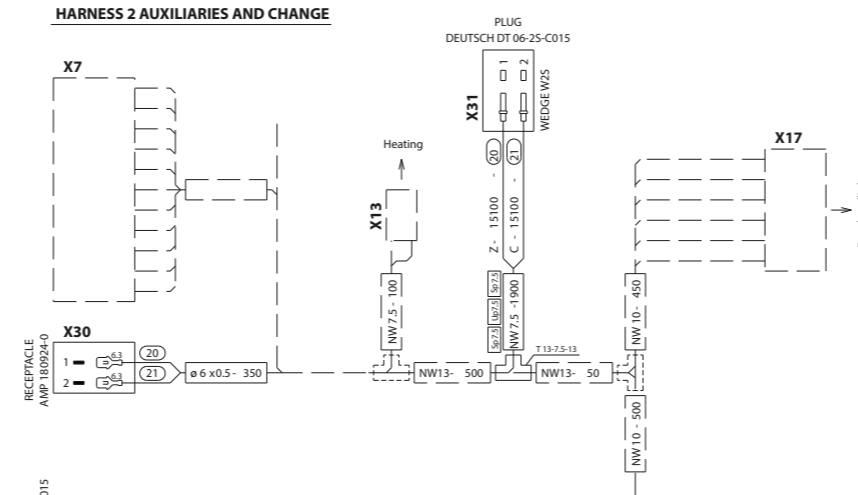

TABLE OF ORIGINAL SYMBOLS:

B	Wálite
C	člencák
H	člencák
M	člencák
R	Redá
S	člencák
Y	člencák
Z	člencák

CLICK HERE TO **DOWNLOAD** THE COMPLETE MANUAL

- Thank you very much for reading the preview of the manual.
- You can download the complete manual from: [www.heydownloads.com](http://www.heydownloads.com) by clicking the link below



- Please note: If there is no response to CLICKING the link, please download this PDF first and then click on it.

CLICK HERE TO **DOWNLOAD** THE COMPLETE MANUAL