

Tigercat®

(ENG) 600'E' SERIES SKIDDER VEHICLE
MOVING AND TRANSPORTING
INSTRUCTIONS

(POR) SKIDDER SÉRIE 600'E' INSTRUÇÕES
DE MOVIMENTAÇÃO E TRANSPORTE

(RUS) ИНСТРУКЦИЯ ПО
ТРАНСПОРТИРОВКЕ И УПРАВЛЕНИЮ
ТРЕЛЕВЩИК СЕРИИ 600'E'

(SPA) SKIDDER SERIE 600'E' INSTRUCCIONES
DE DESPLAZAMIENTO Y TRANSPORTE
DEL VEHICULO

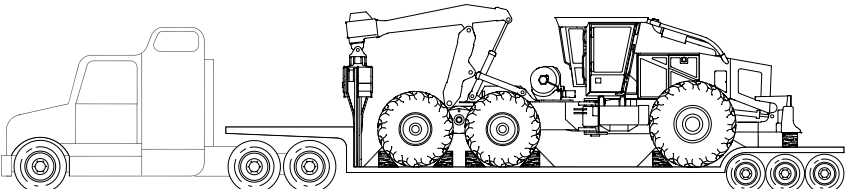
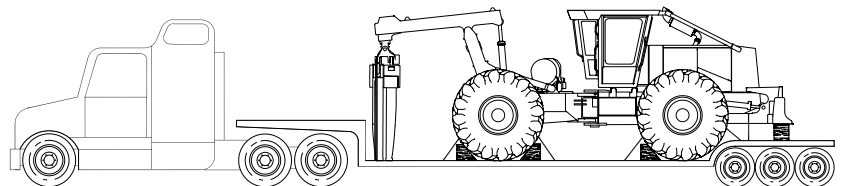

CLICK HERE TO **DOWNLOAD** THE COMPLETE MANUAL

- Thank you very much for reading the preview of the manual.
- You can download the complete manual from: www.heydownloads.com by clicking the link below



- Please note: If there is no response to CLICKING the link, please download this PDF first and then click on it.

CLICK HERE TO **DOWNLOAD** THE COMPLETE MANUAL

6. Ensure that the parking brake is engaged.
7. Check that outside personnel have not moved into a hazardous location near the machine, before starting the engine.

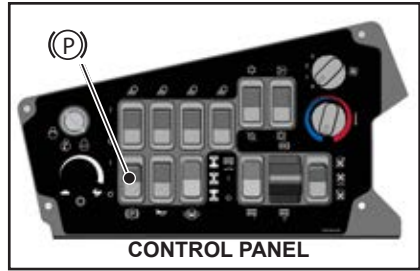

8. Press horn button  several times to alert personnel in the area of your intent to start engine. The horn button is located in the center of the steering wheel.



9. Turn key switch to RUN  position and observe computer display.



10. Wait for WAIT TO START  warning on computer display to turn off.



15. Para selecionar retrocesso ou avanço, no bastão esquerdo use o interruptor com o ícone .

Este interruptor seleciona o sentido da translação para o pedal translação/motor em uso no momento (seja o frontal ou o traseiro).

O interruptor tem 3 posições.

Para avançar ponha-o em AVANÇO* .

Ponha-o no centro para ele ficar em posição neutra.

Para retroceder ponha-o em RETROCESSO* .

***OBSERVAÇÃO:** O controle de translação da máquina é transferido automaticamente pelo sistema de controle do computador, do pedal frontal de translação/motor para o pedal traseiro de translação/motor conforme a posição do assento de operação. Por tanto, o AVANÇO e o RETROCESSO como descritos acima consideram-se como avanço e retrocesso olhando desde o assento dianteiro ou desde o traseiro respectivamente.

16. Faça a máquina se movimentar premendo o pedal de translação .



PESO DAS MÁQUINAS

Abaixo o peso de cada modelo de Skidder Tigercat Padrão:

- 610E 17915 kg (39500 lb)
- 615E 22315 kg (49200 lb)
- 620E 20410 kg (45000 lb)
- 630E 20630 kg (45500 lb)
- 635E 26300 kg (58000 lb)

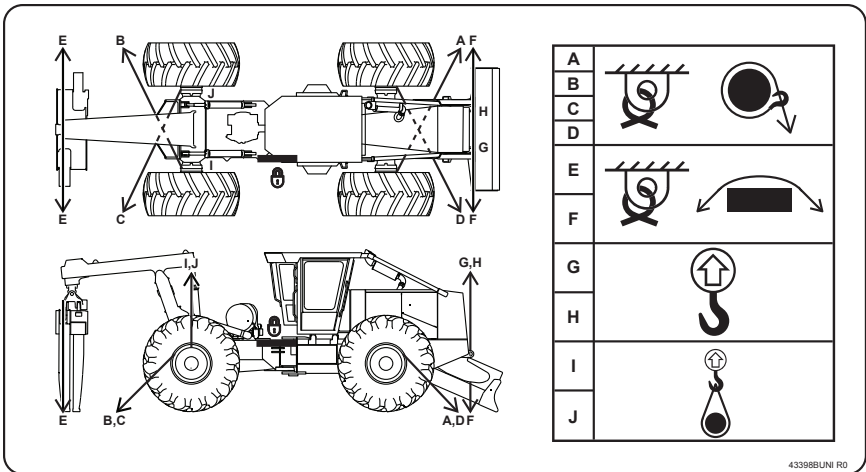

43398LUNI R0

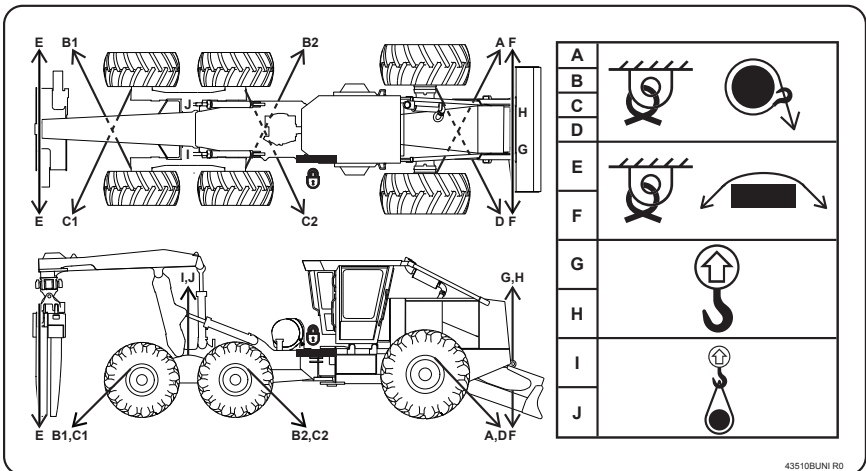



43510BUNI R0

14. Используйте правый джойстик для подъема захвата , расположенного сзади машины. Остерегайтесь препятствий сверху!



15. Начните движение нажатием на ножную педаль  с правой стороны.

Правая педаль - движение ВПЕРЕД .

Левая педаль - движение НАЗАД .

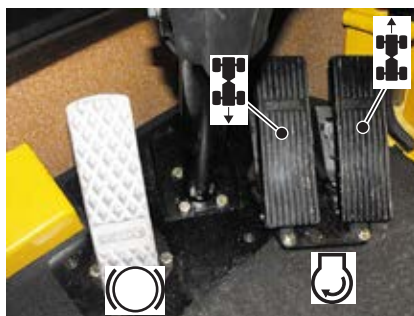

16. Управляйте машиной медленно поворачивая рулевое колесо в нужном направлении.
17. При достижении места назначения необходимо остановить машину.



21. Activar el freno de estacionamiento (P).

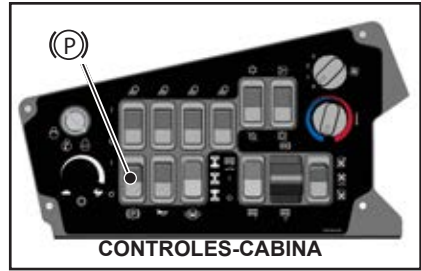

22. Girar el interruptor llave a la posición STOP  para apagar el motor.



23. Si va a transportar la máquina reinstale la barra de bloqueo roja de la articulación, entre el chasis delantero y trasero.



24. APAGAR el interruptor de desconexión de la batería 

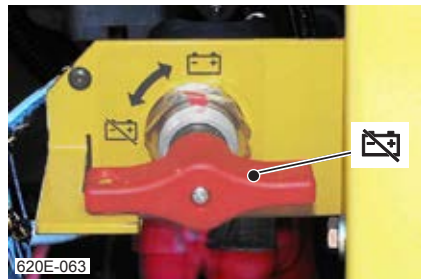

CLICK HERE TO **DOWNLOAD** THE COMPLETE MANUAL

- Thank you very much for reading the preview of the manual.
- You can download the complete manual from: www.heydownloads.com by clicking the link below



- Please note: If there is no response to CLICKING the link, please download this PDF first and then click on it.

CLICK HERE TO **DOWNLOAD** THE COMPLETE MANUAL