



BI012085
FEBRUARY 2013

System Operation Manual

MD6640 Blast Hole Drill

Serial Number DR612176 / 2U70A10

CLICK HERE TO **DOWNLOAD** THE COMPLETE MANUAL

- Thank you very much for reading the preview of the manual.
- You can download the complete manual from: www.heydownloads.com by clicking the link below



- Please note: If there is no response to CLICKING the link, please download this PDF first and then click on it.

CLICK HERE TO **DOWNLOAD** THE COMPLETE MANUAL

Introduction

GENERAL INFORMATION

This manual is designed to assist the owner in the operation of this machine. By following easy to understand step-by-step procedures the operators can perform all tasks in a safe manner.

THIS MANUAL IS NOT THE PARTS BOOK, and cannot be used as reference material to order parts. A separate, detailed parts book has been supplied. Please carefully read the instructions in it. All parts are listed by group and/or product code numbers with the associated item/part numbers for THIS SPECIFIC MACHINE. Order parts in the exact quantity needed. RIGHT and LEFT refer to machine locations as viewed by the operator sitting in the operator's seat in the cab. Please state the correct machine SERIAL NUMBER when corresponding or contacting the factory service or parts departments. Records on each machine are filed by serial number and when given this number, your machine's specific design and original equipment is accessed quickly by the Caterpillar Global Mining parts representative. Periodic additions or revisions may be made to this manual. Should you require additional information or factory service assistance contact your regional service representative or:

Caterpillar Global Mining, LLC
Mining Products Division
3501 S FM 1417
Denison, TX 75020
903-786-9621

The company reserves the right to make changes or add improvements to its machines at any time. This will be without incurred obligations to install such changes on machines sold previously. Due to this ongoing program of product research and development some procedures, specifications and parts may be altered in a constant effort to improve our machines.



sed_1150

Stored Energy Signs

PULLDOWN GEARCASE

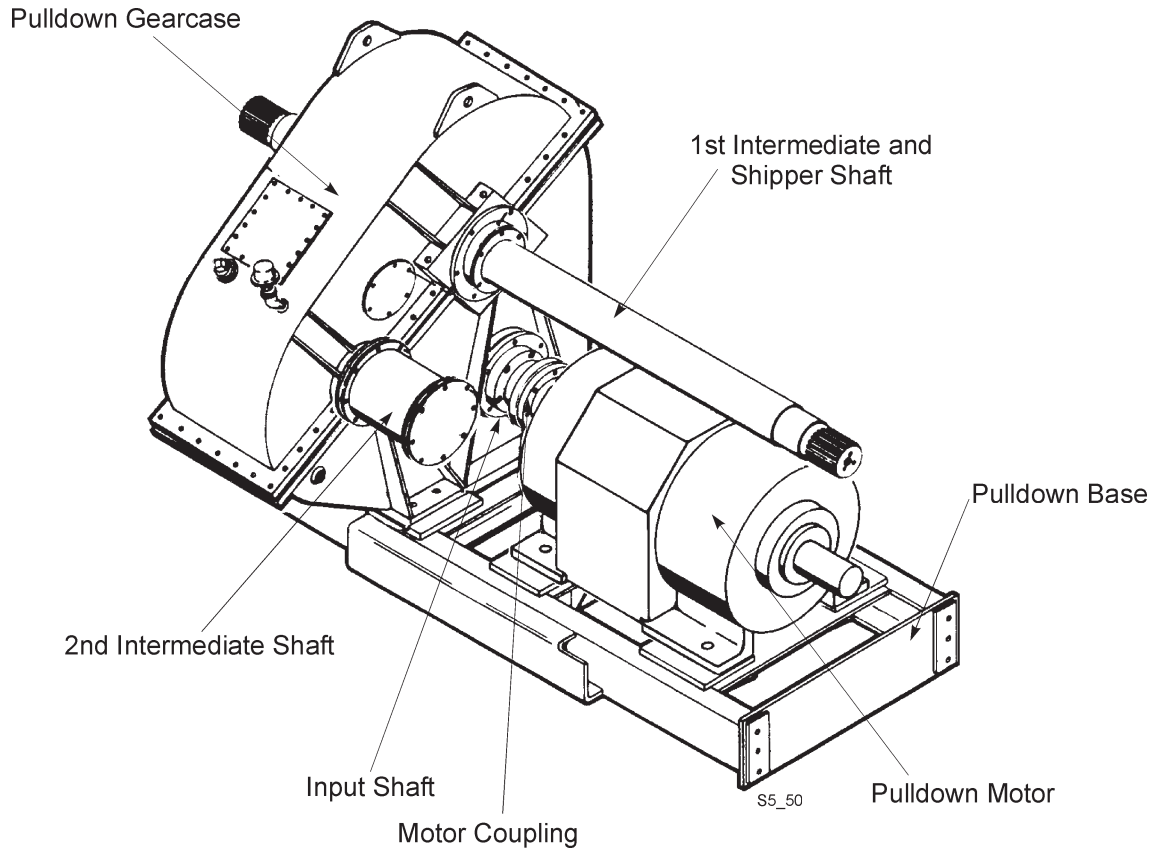

BI012085

ROTARY DRIVE SPEED SELECTOR SWITCH

The rotary speed selector switch is a three position switch located above the rotary rheostat. This switch determines the speed/torque range of the rotary motor. In the LOW position, the motor has the highest torque capability but is limited in speed to about 85-100 RPM at the bit. In the HIGH position, the motor has a higher speed capability (110-140 RPM range) but motor torque will be less (typically 68% to 74%). The MEDIUM position provides for operation between the HIGH and LOW positions.

The switch should be set to the range that most closely matches the desired bit speed range. The LOW setting is sufficient for most conditions. If more speed is desired, select the desired range as needed.

HOIST/PULLDOWN RHEOSTAT

The hoist/pulldown rheostat controls the speed and direction of the hoist-pulldown motor for hoisting or lowering the rotary drive unit.

Turning the rheostat in the hoist direction from the "0" position will raise the rotary drive unit. Maximum speed is available at full clockwise position.

Turning the rheostat in the pulldown direction from the "0" position will lower the rotary drive unit. Maximum speed is available at full counterclockwise position.

NOTE: The rheostat utilizes a reference scale and pointer. When the rheostat is turned, the pointer indicates, on the reference scale, the relative percentage of full speed being set.

The panels with controls as shown on the following pages are typical of what could be included on a console.

DUST CONTROL ON/OFF SWITCH — OPTION

The dust collector switch is a two position switch used to start the fan on the dust collector hopper. When the switch is in the OFF position, it will shut the dust collector fan motor off.

DUST CURTAIN SWITCH — OPTION

The dust curtain switch is a two-position switch. Turning the switch to the UP position will raise the dust curtains. Turning it to the LOWER position will lower the dust curtains.

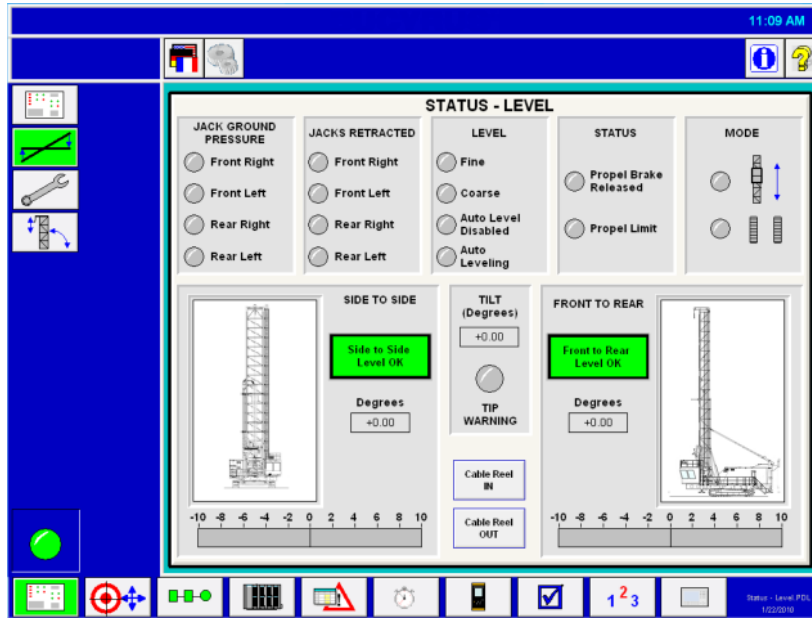

LEVELING SCREEN

The Leveling Screen provides detail on the machine's level and jack status.

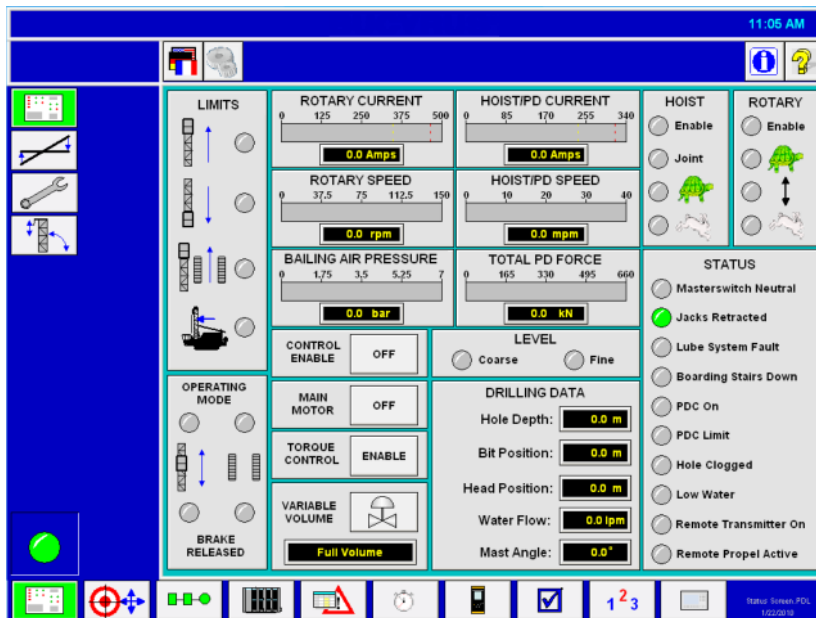

STATUS SCREEN

The Status Screen is the primary operational information tool visible to the machine operator during daily use of this machine. The controls available on this screen will provide the operator with the information needed to view “at a glance” the status of items required for drilling, and make changes in control settings. The Status Screen is most commonly used during the drilling process.

CLICK HERE TO **DOWNLOAD** THE COMPLETE MANUAL



























- Thank you very much for reading the preview of the manual.
- You can download the complete manual from: www.heydownloads.com by clicking the link below



- Please note: If there is no response to CLICKING the link, please download this PDF first and then click on it.

CLICK HERE TO **DOWNLOAD** THE COMPLETE MANUAL

The symbols used on the transmitter label are as follows:

		Turn transmitter power off, on.
	 	Battery, transmit, E-stop lamps – see below.
		Joystick button
		Track, winch brake release (joystick enable)
		Track, winch mode
		Left track, right track forward
		Left track, right track reverse
		Winch down, up
		Propel speed fast, slow
		Boarding stairs down, up
		Horn
		Auto leveling extend, retract
		Dust curtain lower, raise
		Cable reel in, out

BI012085

1. Verify that the hoist brake is set. Verify that the tool string is clamped with the tool wrenches to prevent the tools from moving during the propel operation. Also, verify that the tool string is hoisted to a position to avoid striking the ground when the machine is propelled. Verify that the leveling jacks are fully retracted and that the dust curtains are fully raised. Verify that the boarding stair is raised.
2. Move the operating mode selector switch to PROPEL or REMOTE PROPEL. The remote propel is radio controlled.
3. Press the drill/propel control ON push-button. The automatic leveling/propel screen will appear on the operator's display terminal. If the propelling is being done from the remote propel station, turn the enabling key switch to the ENABLE position.
4. At the control console or remote propel station, turn the propel selector switch to the SLOW SPEED position.

NOTE: There are two propel speeds available to the operator, SLOW SPEED (MAX = 0.27 MPH; 0.44 KM/H) and NORMAL (MAX = 0.9 MPH; 1.45 KM/H). For the inexperienced operator or for maneuvering in tight spots and in drill patterns, the SLOW SPEED setting allows for a more relaxed control operation.

When the operator becomes more proficient or when moving from one site to another, the increased speed of normal propel is used.

5. To propel straight forward lift up on both joysticks to unlatch them and release the propel brakes, then move both joysticks slowly forward. Speed is increased as the levers are moved forward. To propel straight in reverse pull both joysticks slowly to the rear. Speed is increased as the levers are pulled.

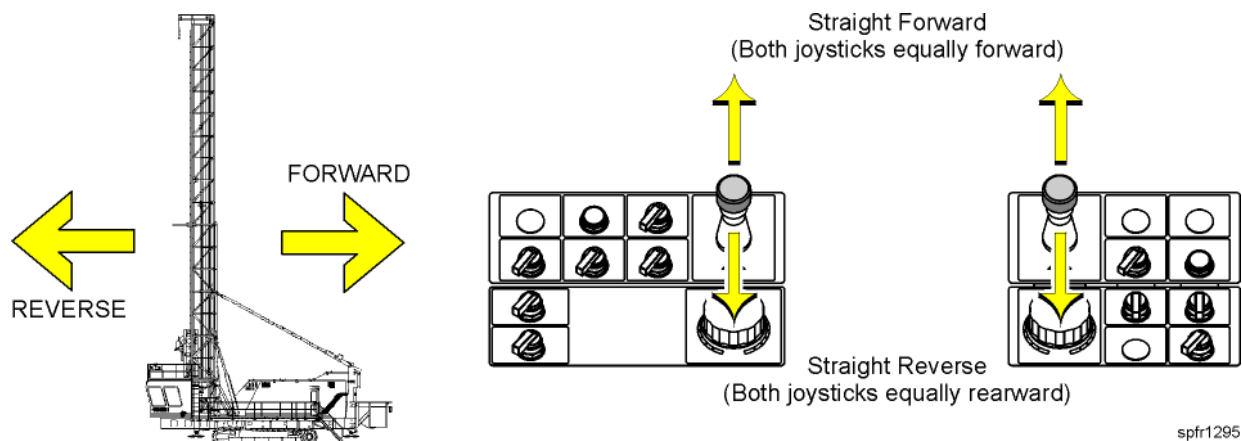

spr1295

STRAIGHT PROPEL - FORWARD OR REVERSE

BI012085

NOTE: Pay close attention to the hoses, wires and cables that run between the mast support and the mast to prevent damage to the machine as the mast is being raised. Have a helper watch from a safe position on the left side of the machine as the mast is going up.

- Once the mast is vertical, move the mast lock switch located on the mast screen on the operator's display to the LOCK position to lock the mast in the vertical position. Mast Pins Locked light on operator's display screen will illuminate when mast is locked in position. Turn the mast brace lock switch to the LOCKED position to secure the mast and brace in the vertical position.

NOTE: When moving the mast for angle hole drilling, on machines with mast lengths of 65 ft (19.8 m) or more, the drill pipe must be stored in the racks and the rotary head lowered to its lowest position.

- If the mast is to be set up for angle drilling move the A-frame lock switch and the mast brace lock switch to the UNLOCK position to release the A-frame front leg lock pin and mast brace lock pins. The readout (A-Frame Pins Unlocked and Mast Brace Pin Unlocked) will show up on the mast status screen on operator's display screen.

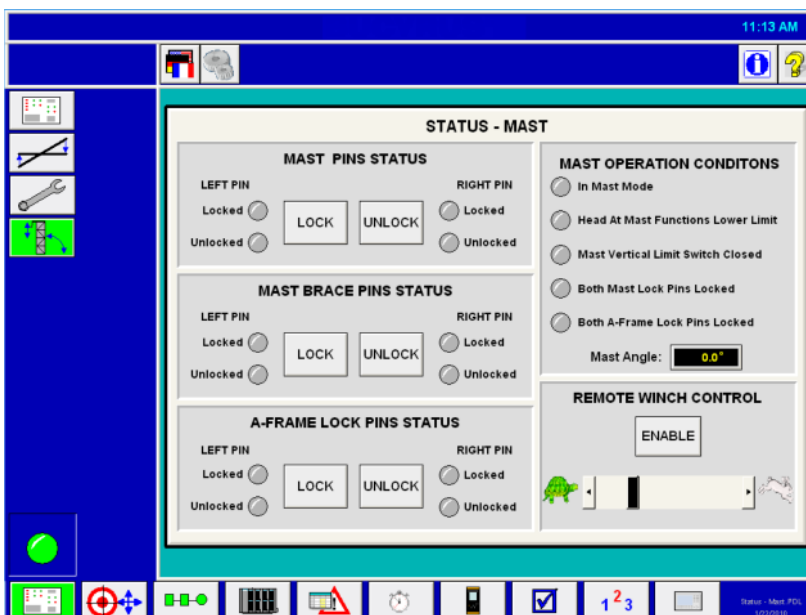

MAST STATUS SCREEN

- Verify that the operation mode selector switch is still in the mast/winch position, then lift and pull the mast joystick slowly to the rear. Slowly lower the mast to the desired drilling angle, then turn the mast brace lock switch to the LOCKED position to secure the mast and brace in the desired position.

BI012085

NOTE: The use of stabilizers that have been modified or that do not allow this procedure to be used should be avoided. The use of nonstandard stabilizers will make assembly and disassembly of the tool string difficult and dangerous.

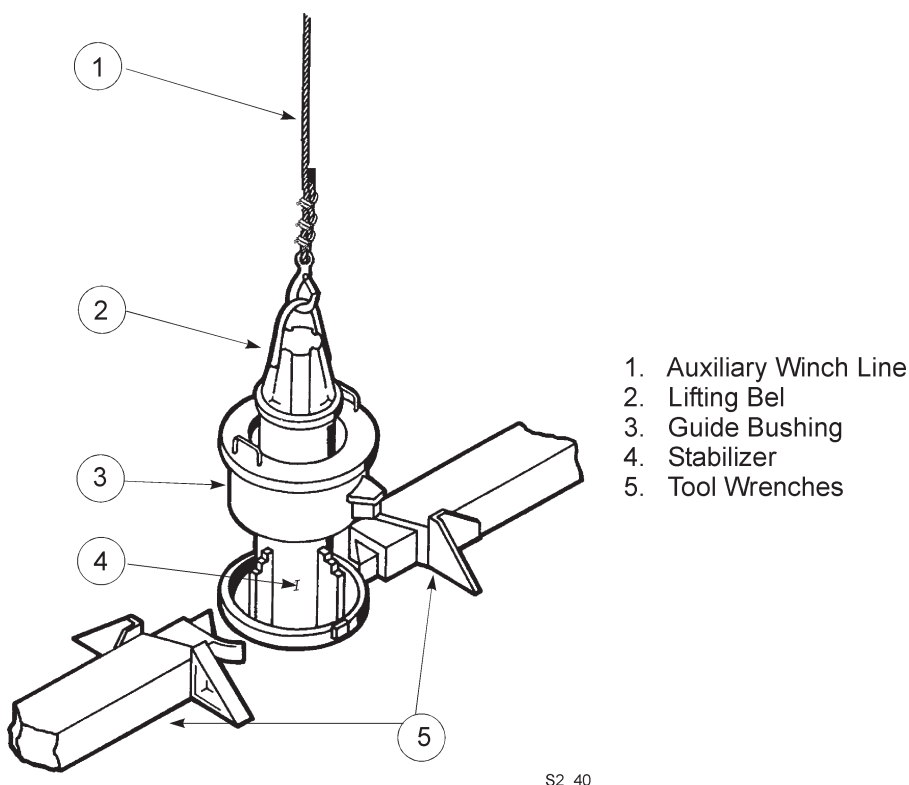

STABILIZER INSTALLATION

To install a single section of drill pipe proceed as follows:

1. Lower the rotary/pulldown unit until the pipe coupling on the unit can be reached from the drill deck. Set the hoist brake and press the drill/propel control OFF push-button. Clean the inside threads on the coupling to remove any dirt or old lubricant. Apply a coat of drill thread compound to the threads and shoulder of the coupling.

NOTE: Use only drill pipe thread compound on the pipe threads. Drill pipe thread compound contains material that will prevent the threads from seizing and galling under the severe pressure encountered on the pipe threads.

BI012085

All tool handling procedures are carried out the same way either in angle drilling or in standard vertical drilling. The only addition to the procedures is the use of the pipe positioner to hold the drill pipe to be threaded together in position and a mast A-frame with adjustable front legs. It also includes an adjustable pipe seal which can be moved to align with the drill pipe.

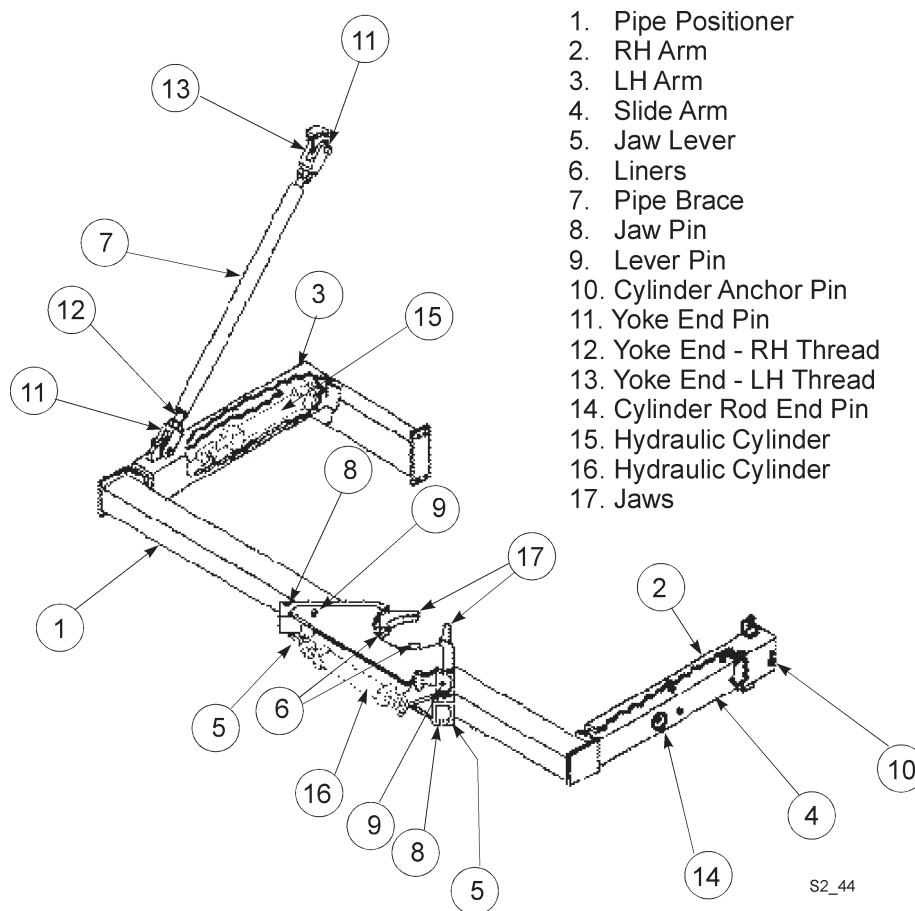

PIPE POSITIONER

During angle drilling the deck remains horizontal providing a horizontal surface to work from. The drill pipe, however, is laying at the angle of the mast. In order to make a joint at the drilling deck, such as when adding the stabilizer, bit or drill pipe or when removing these components, it is necessary to hold the drill pipe in position so as to line up with the drill pipe or component being held on the drill deck. This is the function of the pipe positioner.

The pipe positioner is moved into position by hydraulic cylinders. The pipe positioner jaws are opened by a single hydraulic cylinder.

NOTE: Do not operate the rotary machinery except at low speeds to make and break joints while the jaws are closed around the pipe. Operating the rotary machinery at high speeds or drilling while the pipe positioner jaws are closed around the pipe will damage the jaws and positioner structures.

BI012085

UNCONSOLIDATED MATERIALS

Drilling unconsolidated materials may present two problems. The first, and most severe, is the vibration encountered if the penetration rate is too fast. As the bit rotates the cones pass over the material and the teeth or inserts chip away at the material being drilled. Unconsolidated material, however, has voids in it. When the bit passes over a void in the material it only contacts part of the bottom of the hole. As each roller passes through the void, the tool string moves down, as the roller falls into the void, and then back up as the roller climbs out. This continual up and down motion results in shock loads being transmitted from the bit, through the tool string, to the machine.

To drill through an unconsolidated formation it is necessary to reduce the load on the bit as it is passing over the voids. It is also helpful to isolate the shock loading to the tool string. This is accomplished by first reducing the pulldown speed. If reducing the pulldown speed does not reduce the vibration to the machine to an acceptable limit, it may even be necessary to hoist the bit above the void and then lower the bit a small amount at a time so as to chip away at the sides of the void a little at a time. Reduction of the rotary speed will also help reduce the vibration of the tool string. This is the last procedure that should be tried since if the pulldown speed is left high and the rotary speed diminished, the vibration will be just as severe, only at a different frequency.

Unconsolidated material presents another problem due to the fact that the voids in the material may allow the bailing air to escape through the sides of the hole, rather than passing along the drill pipe and exiting through the top of the hole. This loss of air reduces the volume of air available to bail the hole, causing the cuttings to fall to the bottom of the hole and be reground by the bit. This further reduces the penetration rate since these cuttings must be ground up by the bit and bailed out of the hole or they will plug the hole. Unconsolidated material may also cause the hole to cave in. This creates problems due to the sudden addition of material into the hole and the resultant loss of bailing velocity due to the increased diameter of the hole.

If unconsolidated material is causing the loss of bailing air volume or caving of the hole it is necessary to continually clean the hole as the recycled cuttings or the caved material will plug the hole. Closely monitor both the bailing air pressure and the flow of cuttings from the hole. If the air is being lost the air pressure will remain constant but the flow of cuttings will stop or drastically decrease while penetration does not decrease. Continue drilling for a few feet to try and get past the leak. If the bailing air pressure starts to rise, the hole is plugging. Immediately hoist the tool string until the pressure drops and allow the drill string to rotate for a few moments to clear itself. Then lower the tool string to the bottom of the hole and clean it out. It may be necessary to regrind the cuttings to make them small enough to seal the leak and be bailed out of the hole by reduced air volume. Once the hole is clean, repeat the hoisting and lowering procedure every 2 to 3 feet (0.3 to 0.6 m) to keep it so.

If the material tends to cave in from the sides of the hole, the tool string can become stuck in the hole quickly. If the caved material is small, it will fit between the cones of the roller and fall to the bottom of the hole. The hole can then be cleaned out using the same procedure as for a leaky hole. If the caved material is large it will be necessary to pull the tool string out of the hole and then redrill the caved material.

BI012085

8. Close and completely seal all electrical cabinets.
9. Close and completely seal the operator's cab.
10. Close and completely seal the machinery house. Completely seal the filter fan unit.
11. Completely drain the compressor coolant system.
12. Propel the machine onto blocks to prevent the crawler belts from rusting. Coat the entire crawler belts with a rust preventative oil. Coat the propel chains with a rust preventative oil.
13. Block the leveling jacks in the full retracted position.
14. Manually grease every lube point (including auto lube points).

TOOL RECOVERY

Normally the drill tools are always either connected to the rotary drive unit or are held by the tool wrench. Mistakes, however, do happen and the drill tools may be dropped down the hole. Tool recovery (or tool fishing) is the procedure used to recover these tools.

There are two situations where the tool recovery procedures are necessary and each situation dictates the procedure to be used. The first situation is when the tools have been uncoupled and have fallen below the guide bushing. It is possible in this situation to recover the tool string and, if no damage was done, return to drilling. The other situation is where the drill pipe has broken and has either fallen below the guide bushing or cannot be handled normally.

If the tools have uncoupled and the upper end of the tool string is still above the guide bushing, recouple the tools as would normally be done for tool joint make-up. Clamp the tool string with the tool wrench to aid in making the joint. When the tools are coupled, remove the tool string from the hole, remove the bit and turn the main air on momentarily to clean the inside of the drill pipe. Clean and reinstall the bit and return to drilling.

If the tools have uncoupled and the upper end of the tool string is below the guide bushing but still above ground level, re-couple the tool string as would normally be done to tool joint make-up, except use caution when making the joint. Caution is necessary when making the joint as the tools in the hole will now be at an angle with respect to the tools on the drill. Cross threading of the joint is possible in this situation and should be avoided since it will not only damage the threads but result in an unreliable joint. One method to realign the tools would be to attach a suitable pulling device to the tools in the hole and center the tools with blocking (make sure it doesn't fall down the hole). This would allow normal joint make-up without abandoning the hole. If this is not possible, the leveling jacks may be adjusted to align the tools. Be sure that the stability limits of the machine are not exceeded. It will be necessary to abandon the hole since the drill cannot be repositioned in the exact same orientation as before losing the tools. When the tools are recovered, clean the pipe and bit as detailed in the first procedure of this section and return to drilling.

CLICK HERE TO **DOWNLOAD** THE COMPLETE MANUAL

- Thank you very much for reading the preview of the manual.
- You can download the complete manual from: www.heydownloads.com by clicking the link below



- Please note: If there is no response to CLICKING the link, please download this PDF first and then click on it.

CLICK HERE TO **DOWNLOAD** THE COMPLETE MANUAL