

**400**

**PIECES DE RECHANGE  
REPUESTOS  
ERSATZTEILE  
SPARE PARTS**

**Poclain**

CLICK HERE TO **DOWNLOAD** THE COMPLETE MANUAL

- Thank you very much for reading the preview of the manual.
- You can download the complete manual from: [www.heydownloads.com](http://www.heydownloads.com) by clicking the link below



- Please note: If there is no response to CLICKING the link, please download this PDF first and then click on it.

CLICK HERE TO **DOWNLOAD** THE COMPLETE MANUAL

400CL  
400CK

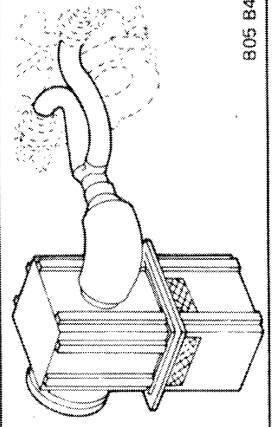

B05 B40

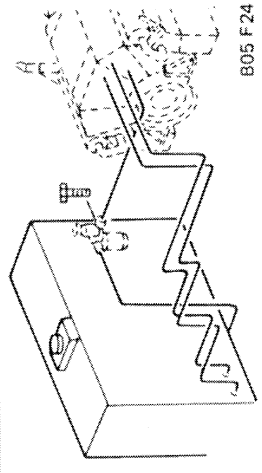

B05 F24

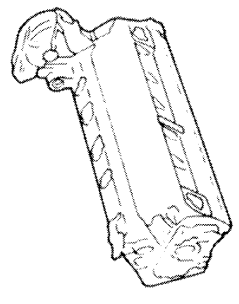

B06 C33

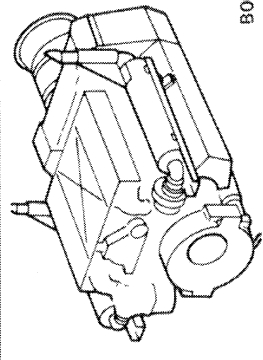

B00 B43

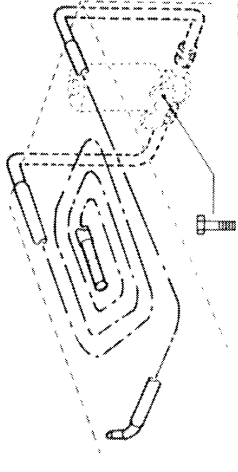

B05 F94

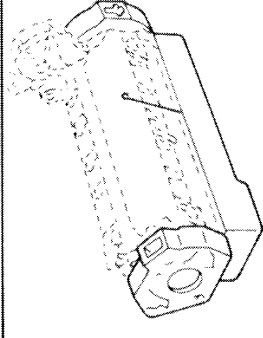

B06 C34

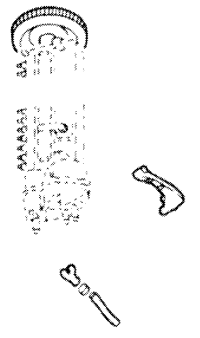

B06 F20

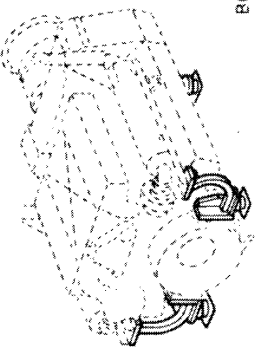

B05 A25

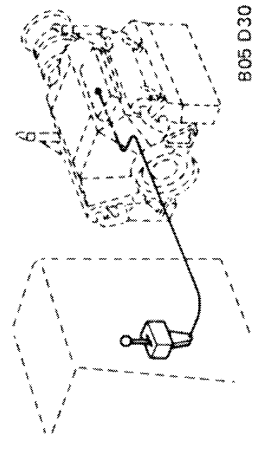

B05 D30

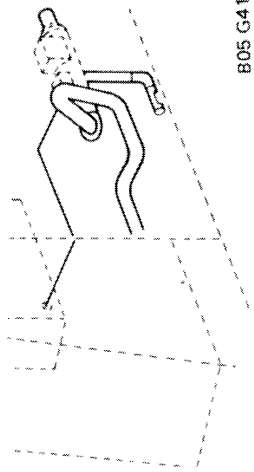

B05 G41

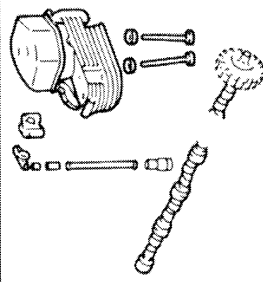

B06 D17

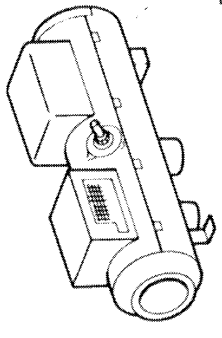

B05 H01

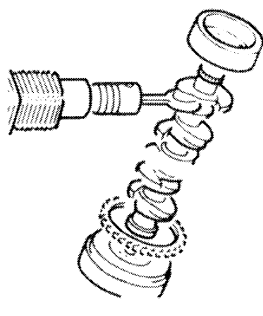

B06 E13

# E 400

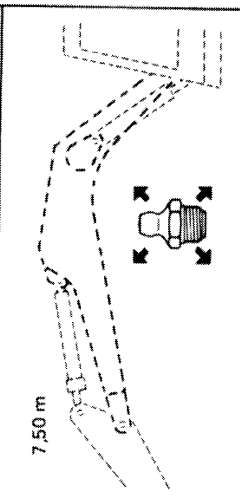
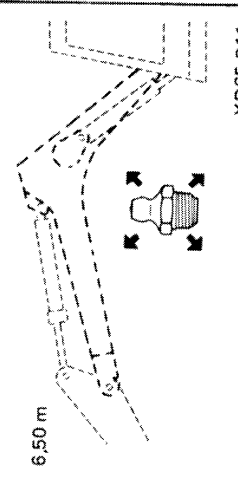
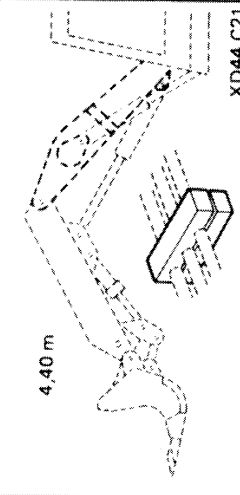
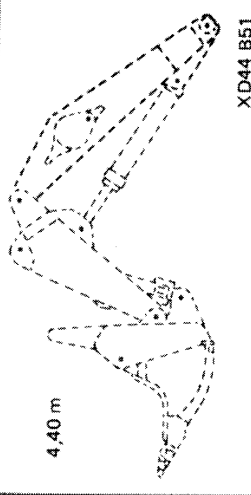
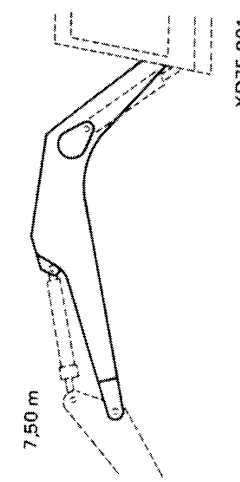
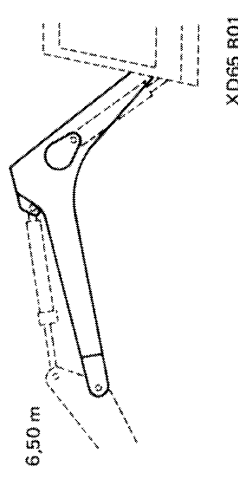
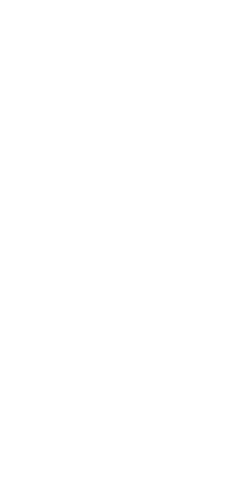
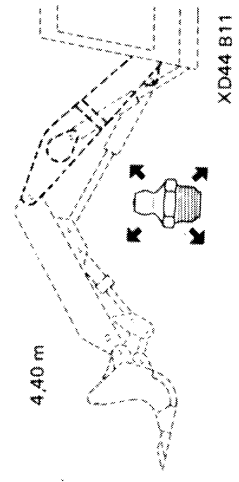
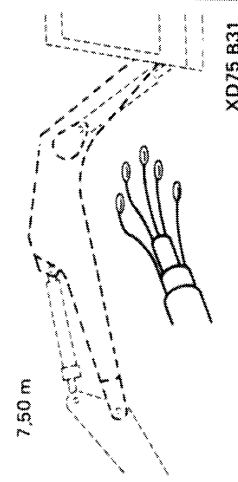
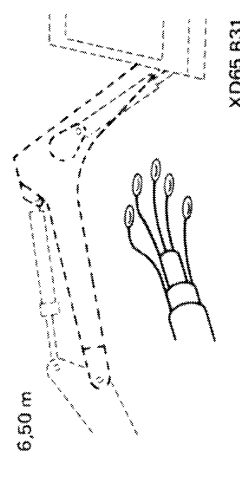
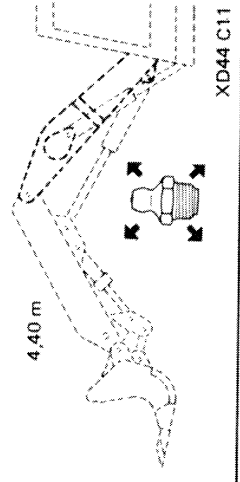
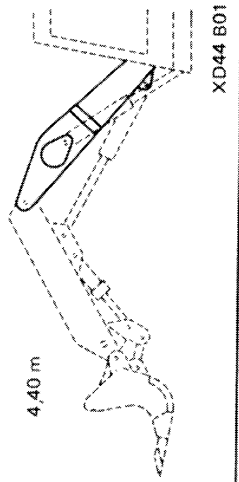
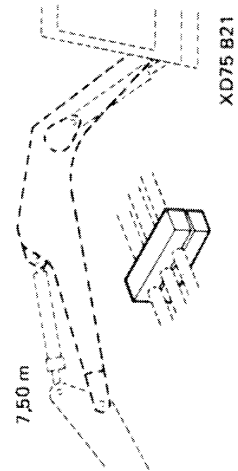
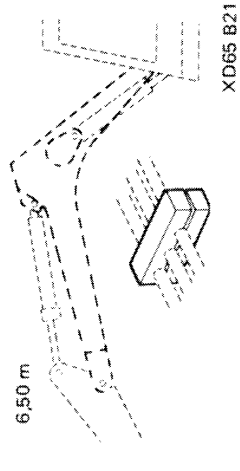
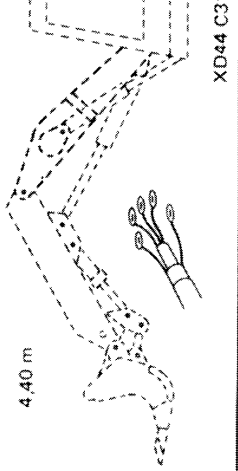
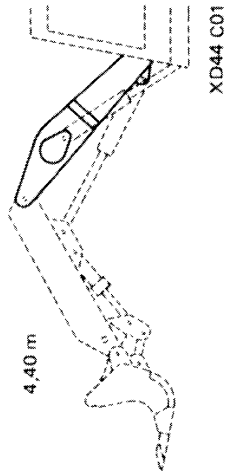

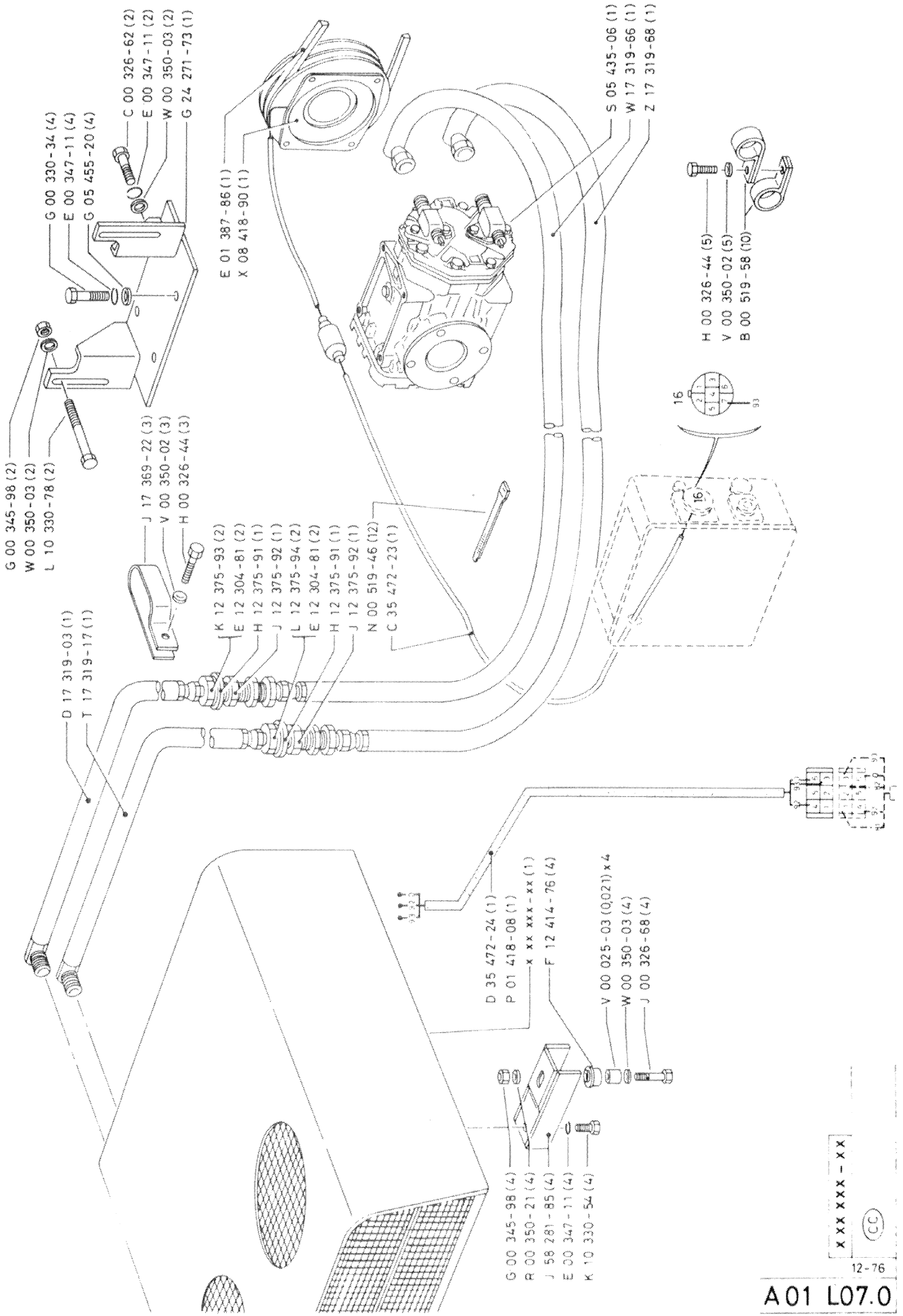

X X X X X - X X  
 CC

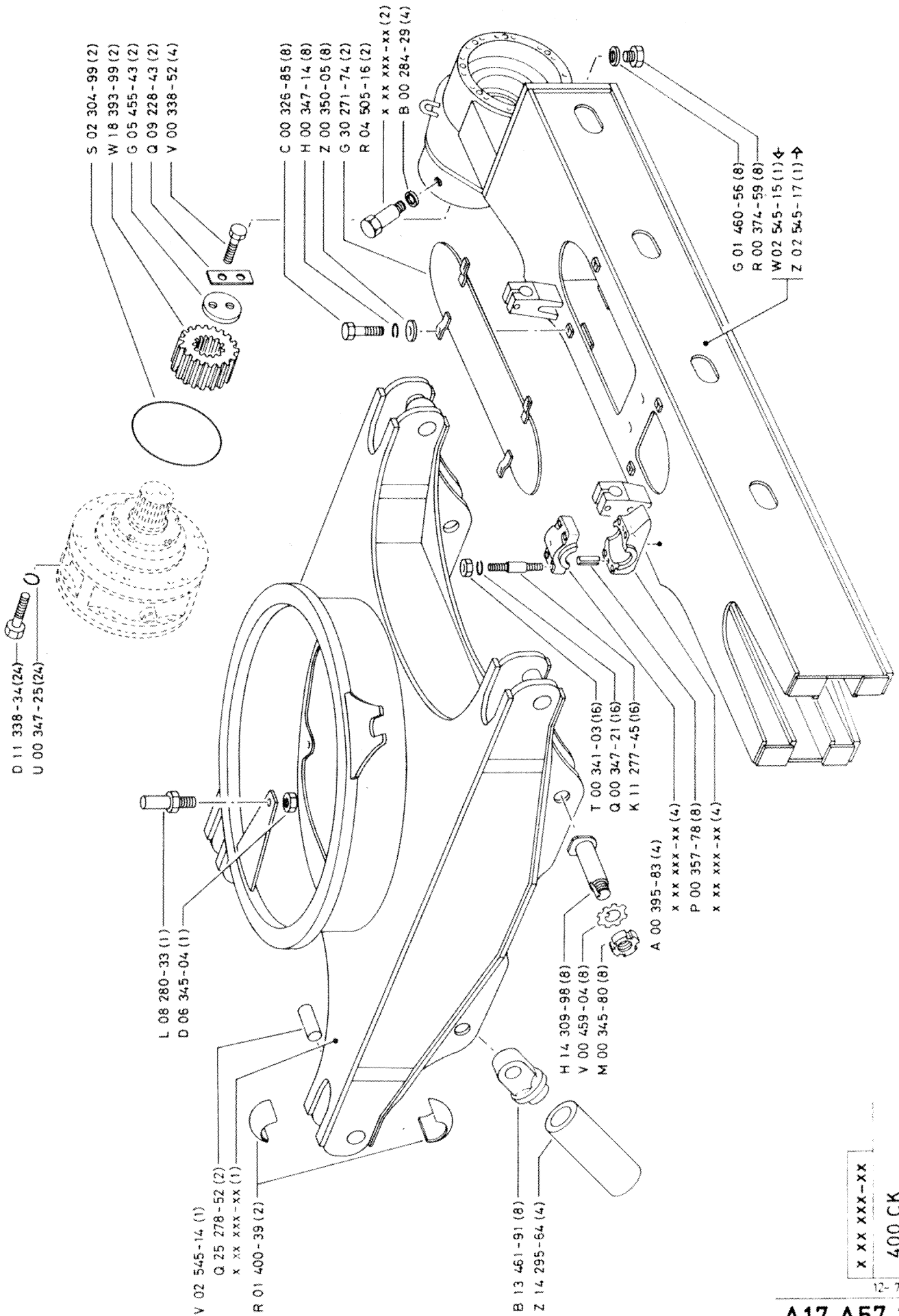

x xx xxx - xx  
 400 CK

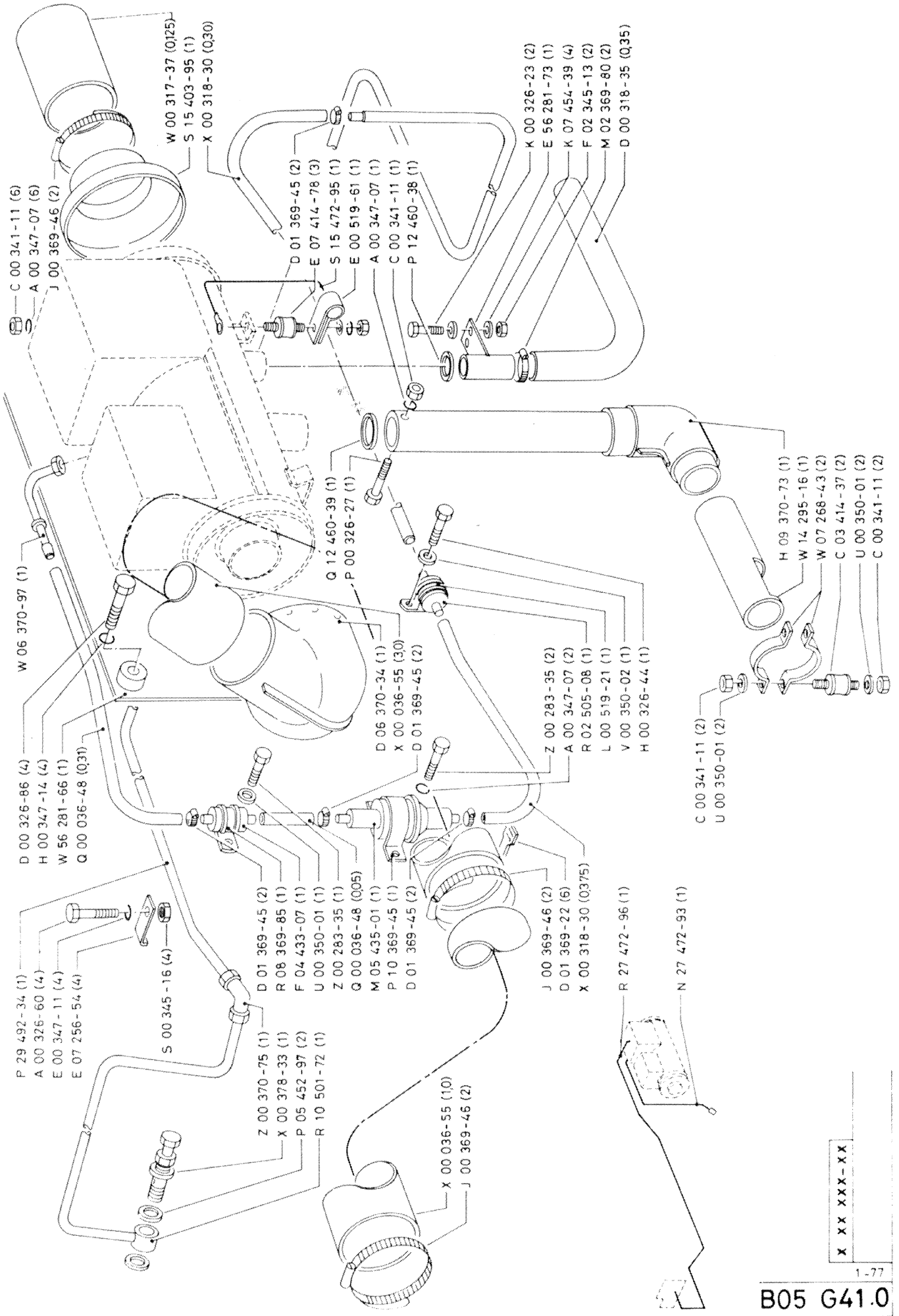

X X X XXX - X X

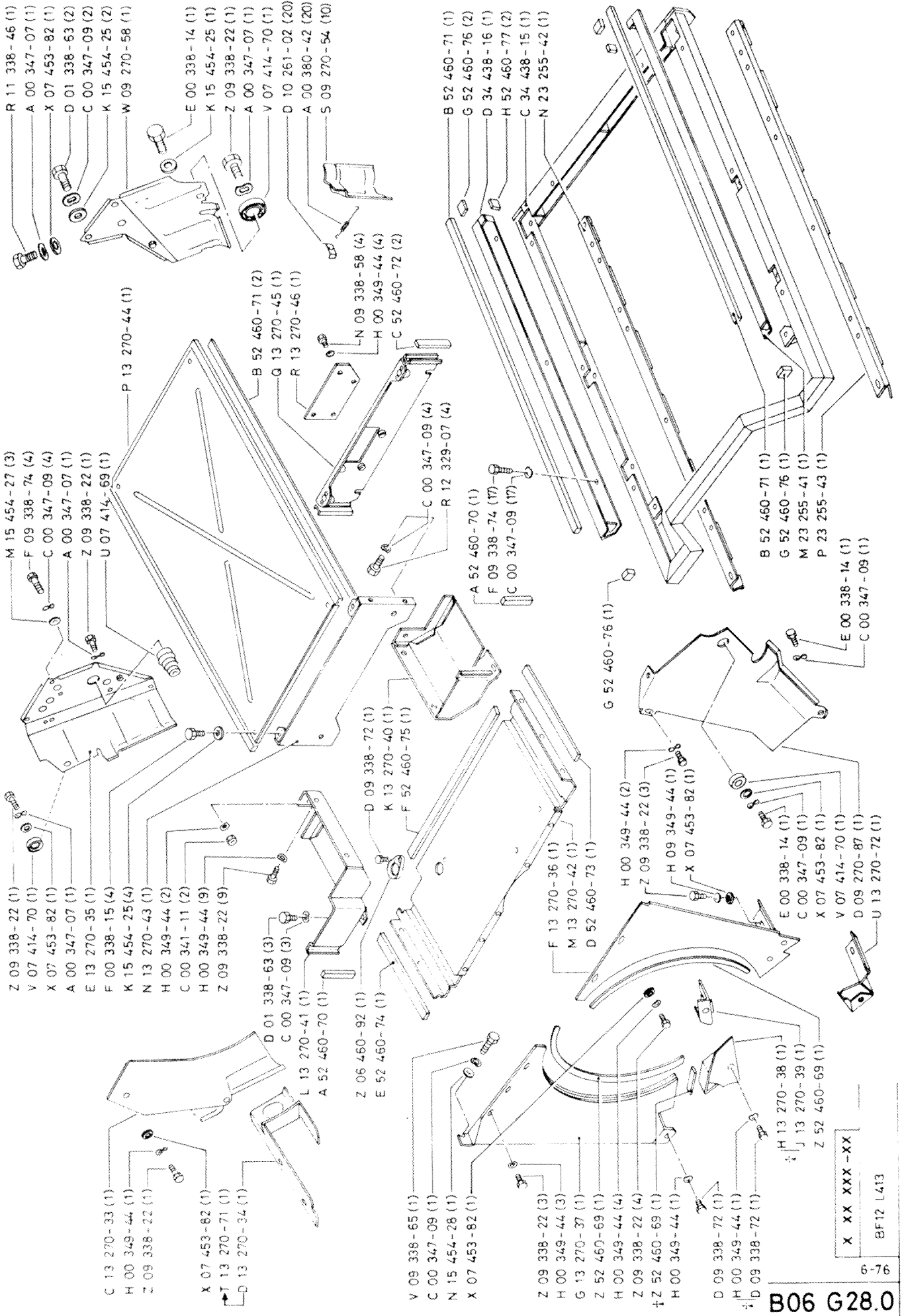

**B06 G28.0**

X XX XXX-XX  
BF12 L413

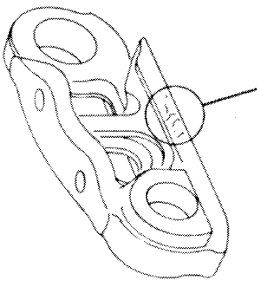

im is

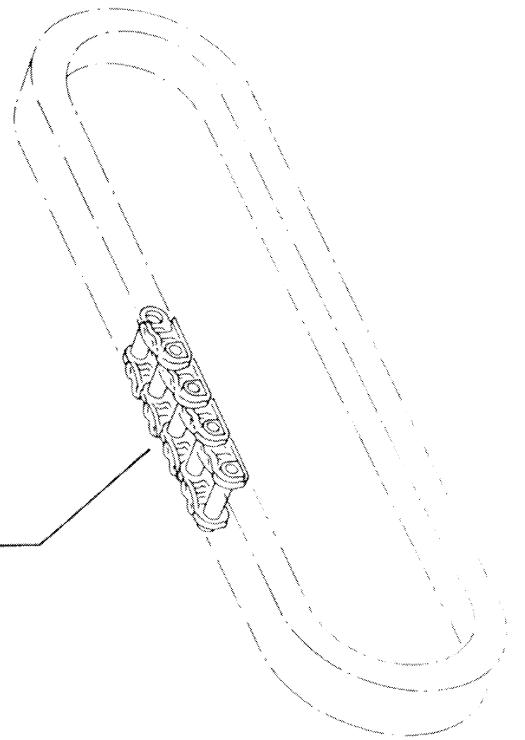
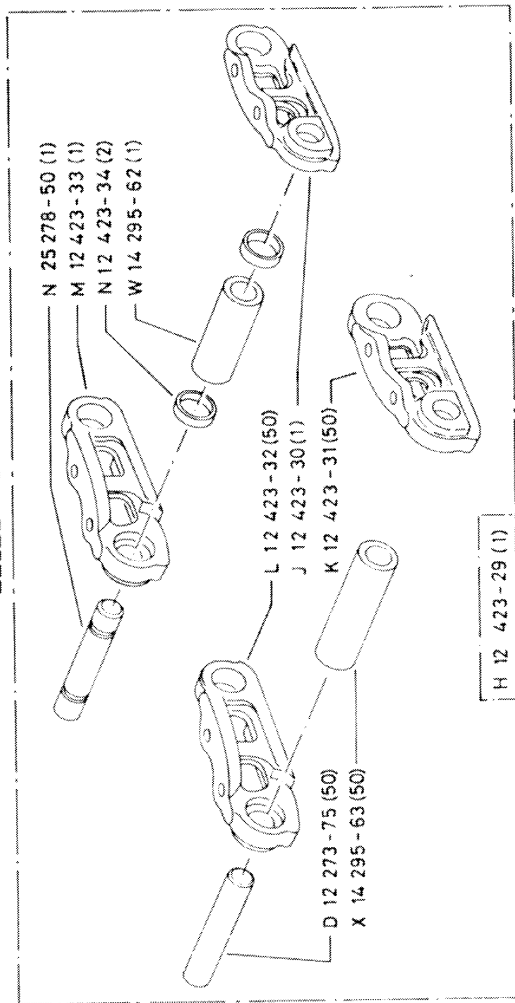

xxx-xx

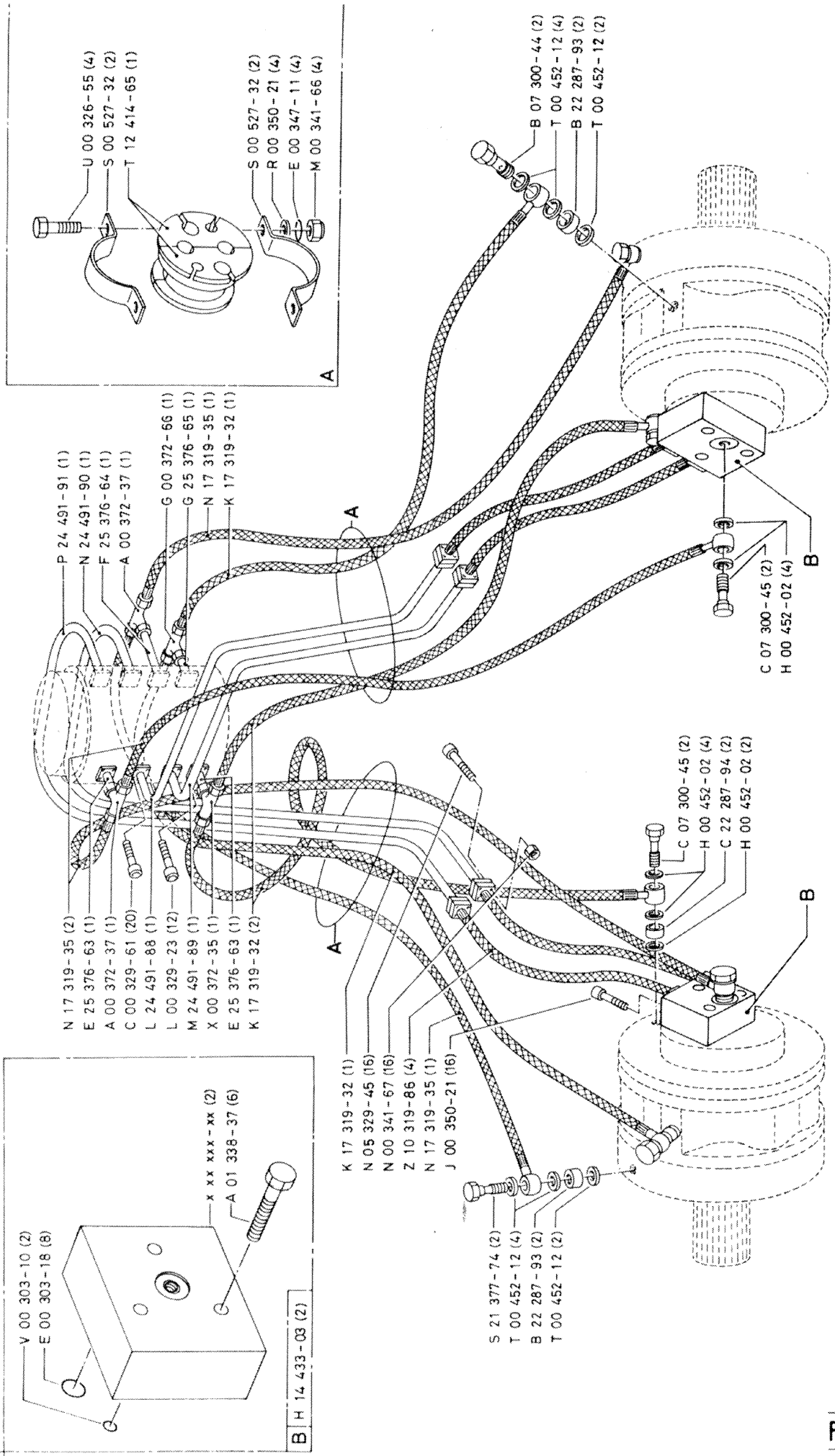

- U 00 326-55 (4)
- S 00 527-32 (2)
- T 12 414-65 (1)
- S 00 527-32 (2)
- R 00 350-21 (4)
- E 00 347-11 (4)
- M 00 341-66 (4)

- P 24 491-91 (1)
- N 24 491-90 (1)
- F 25 376-64 (1)
- A 00 372-37 (1)
- C 00 329-61 (20)
- L 24 491-88 (1)
- L 00 329-23 (12)
- M 24 491-89 (1)
- X 00 372-35 (1)
- E 25 376-63 (1)
- K 17 319-32 (1)
- G 00 372-66 (1)
- G 25 376-65 (1)
- N 17 319-35 (1)
- K 17 319-32 (1)

- N 17 319-35 (2)
- E 25 376-63 (1)
- A 00 372-37 (1)
- C 00 329-61 (20)
- L 24 491-88 (1)
- L 00 329-23 (12)
- M 24 491-89 (1)
- X 00 372-35 (1)
- E 25 376-63 (1)
- K 17 319-32 (2)

- K 17 319-32 (1)
- N 05 329-45 (16)
- N 00 341-67 (16)
- Z 10 319-86 (4)
- N 17 319-35 (1)
- J 00 350-21 (16)

- S 21 377-74 (2)
- T 00 452-12 (4)
- B 22 287-93 (2)
- T 00 452-12 (2)
- C 07 300-45 (2)
- H 00 452-02 (4)
- C 22 287-94 (2)
- H 00 452-02 (2)

- B 07 300-44 (2)
- T 00 452-12 (4)
- B 22 287-93 (2)
- T 00 452-12 (2)

- C 07 300-45 (2)
- H 00 452-02 (4)

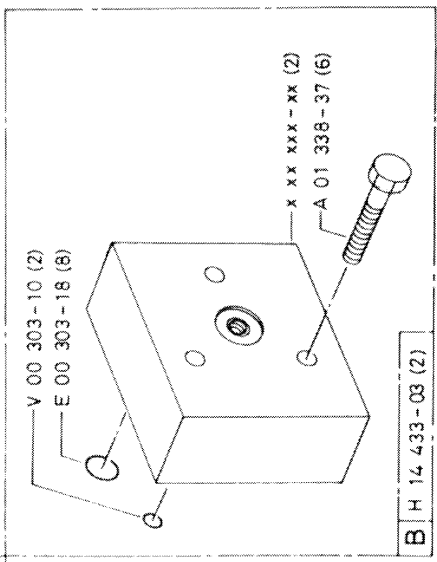

- V 00 303-10 (2)
- E 00 303-18 (8)

- x xx xxx-xx (2)
- A 01 338-37 (6)

B H 14 433-03 (2)

x xx xxx-xx  
M 4400 2CX

CLICK HERE TO **DOWNLOAD** THE COMPLETE MANUAL

- Thank you very much for reading the preview of the manual.
- You can download the complete manual from: [www.heydownloads.com](http://www.heydownloads.com) by clicking the link below



- Please note: If there is no response to CLICKING the link, please download this PDF first and then click on it.

CLICK HERE TO **DOWNLOAD** THE COMPLETE MANUAL

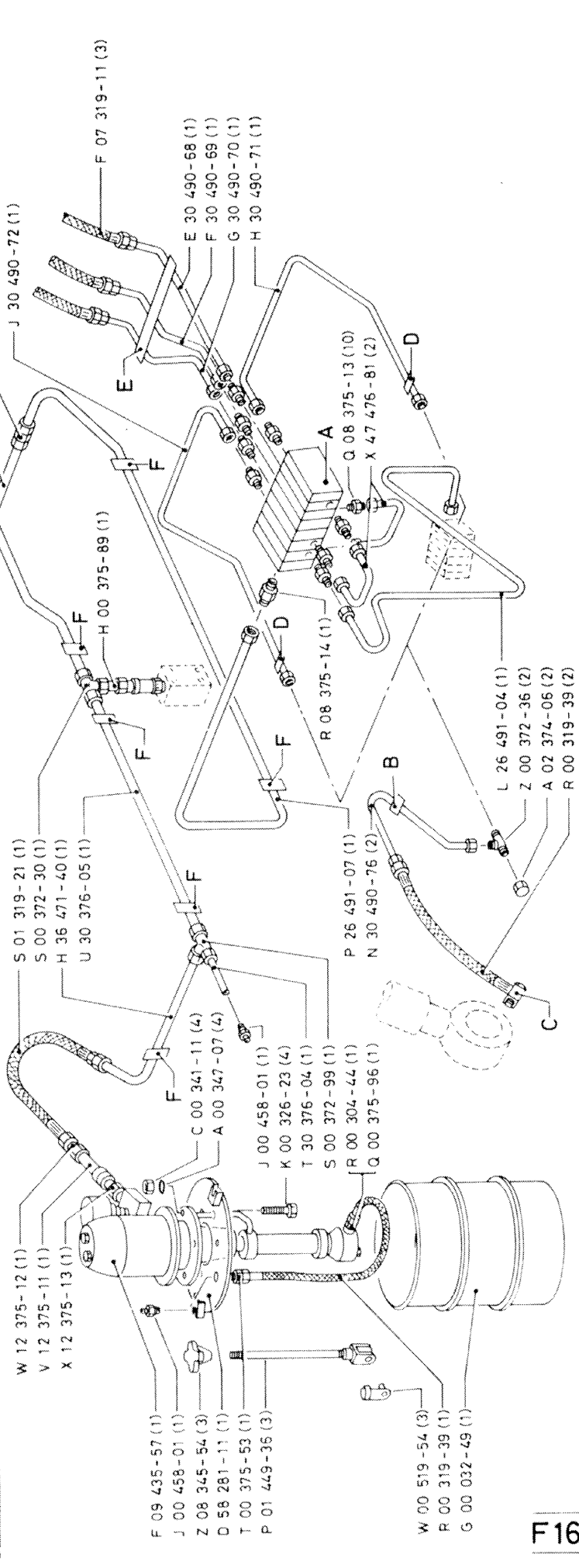
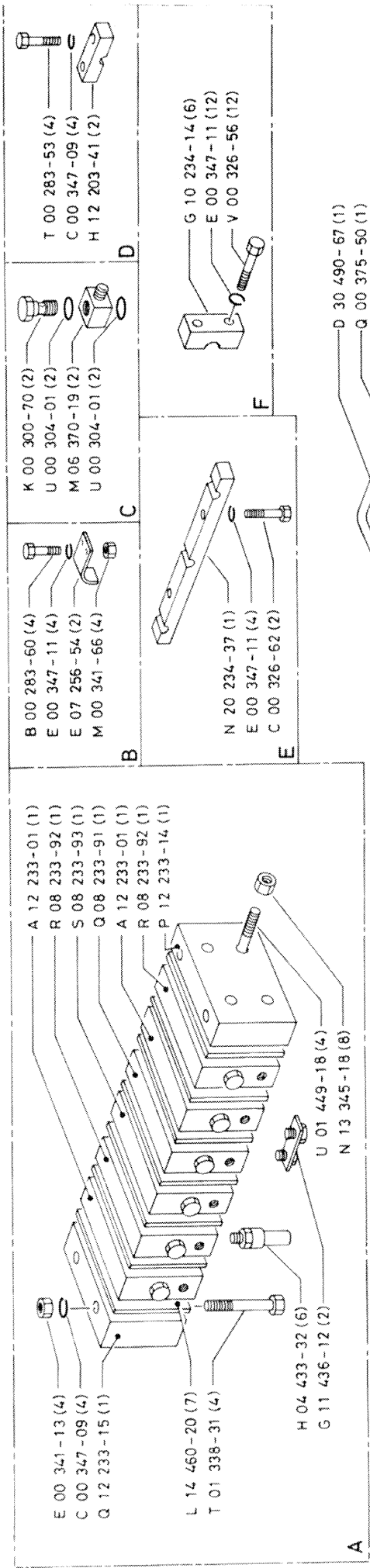

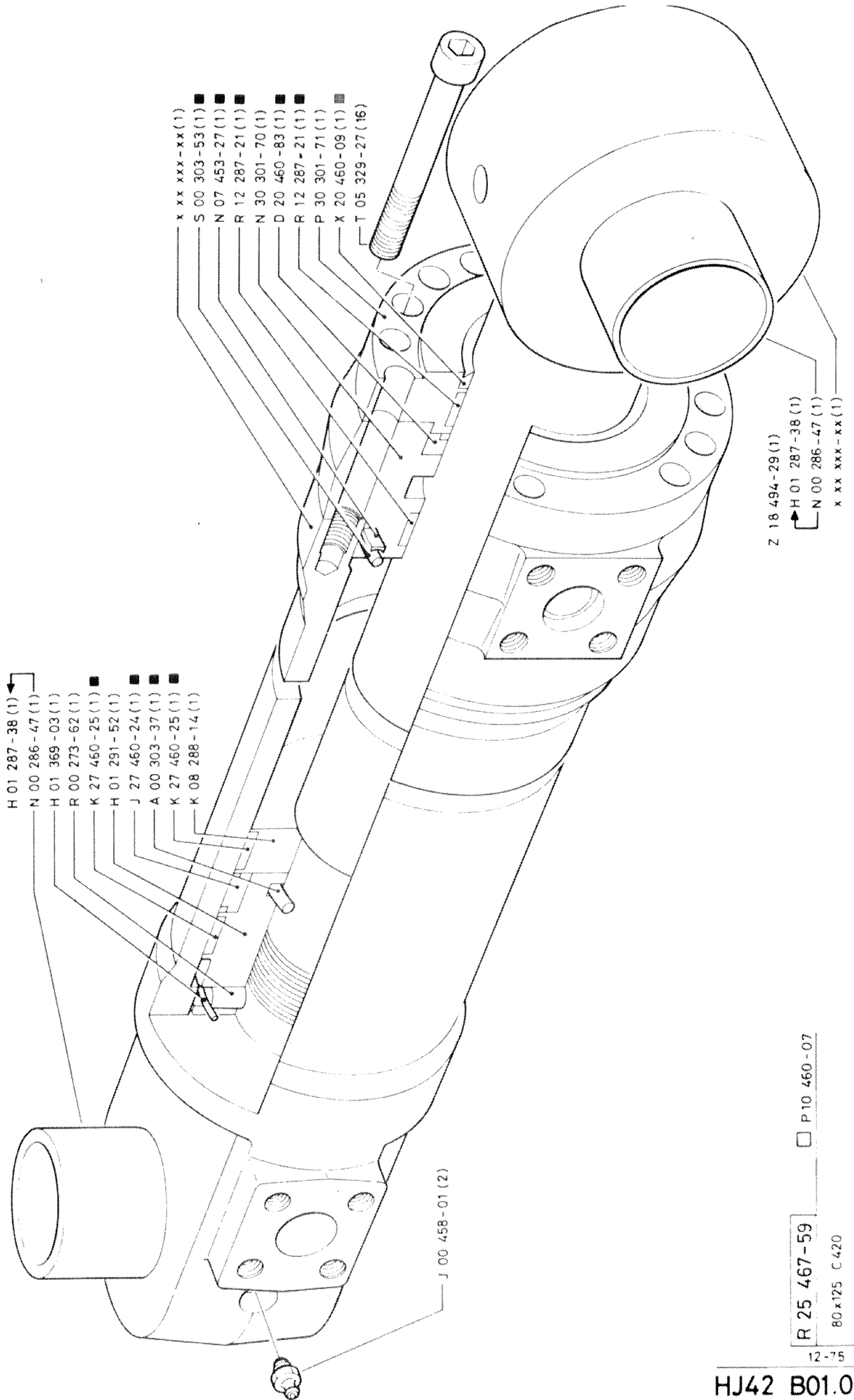

P 10 460 - 07  
 R 25 467 - 59  
 80 x 125 C 420

12-75

HJ42 B01.0

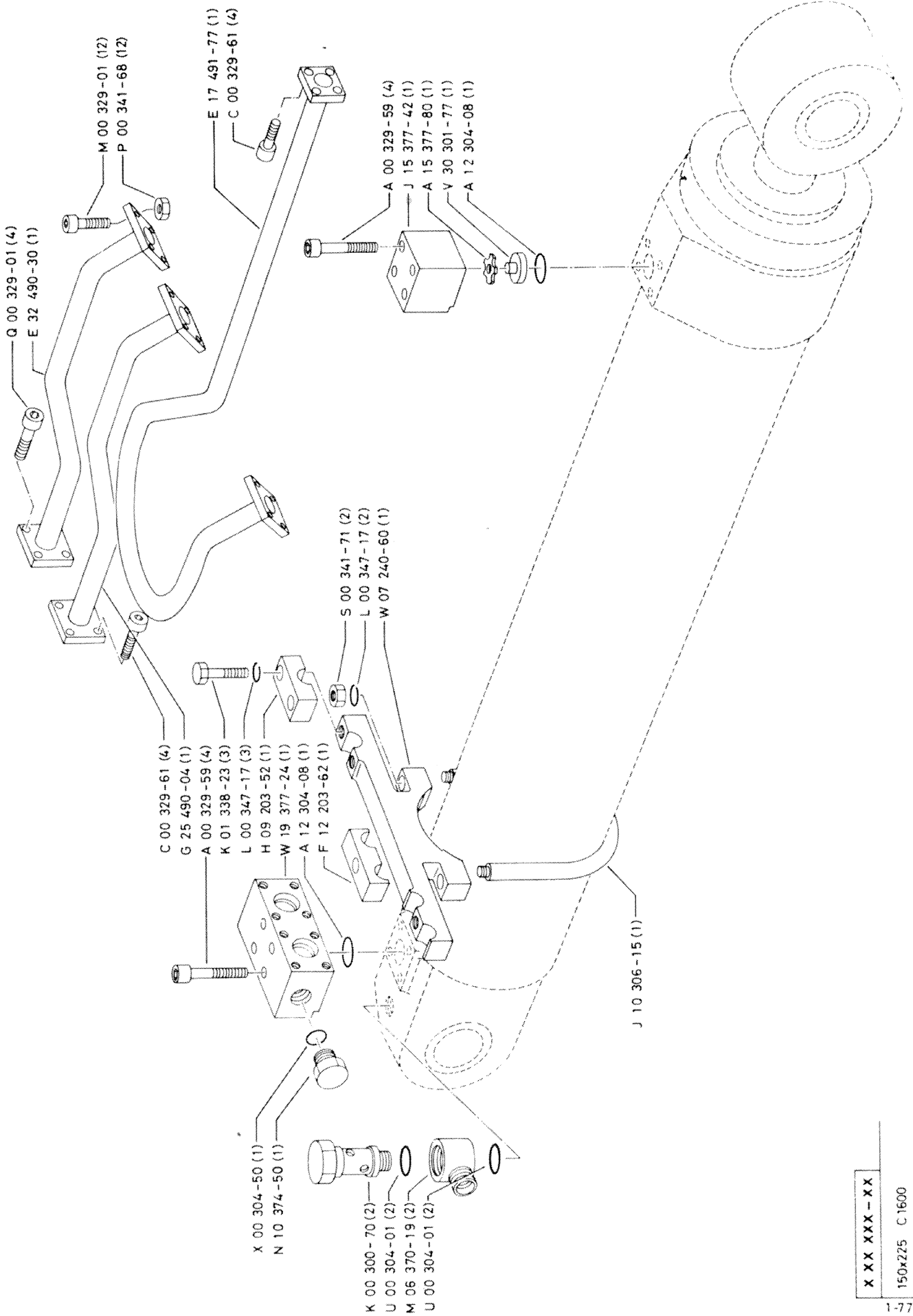

X X X X X X - X X

150x225 C 1600

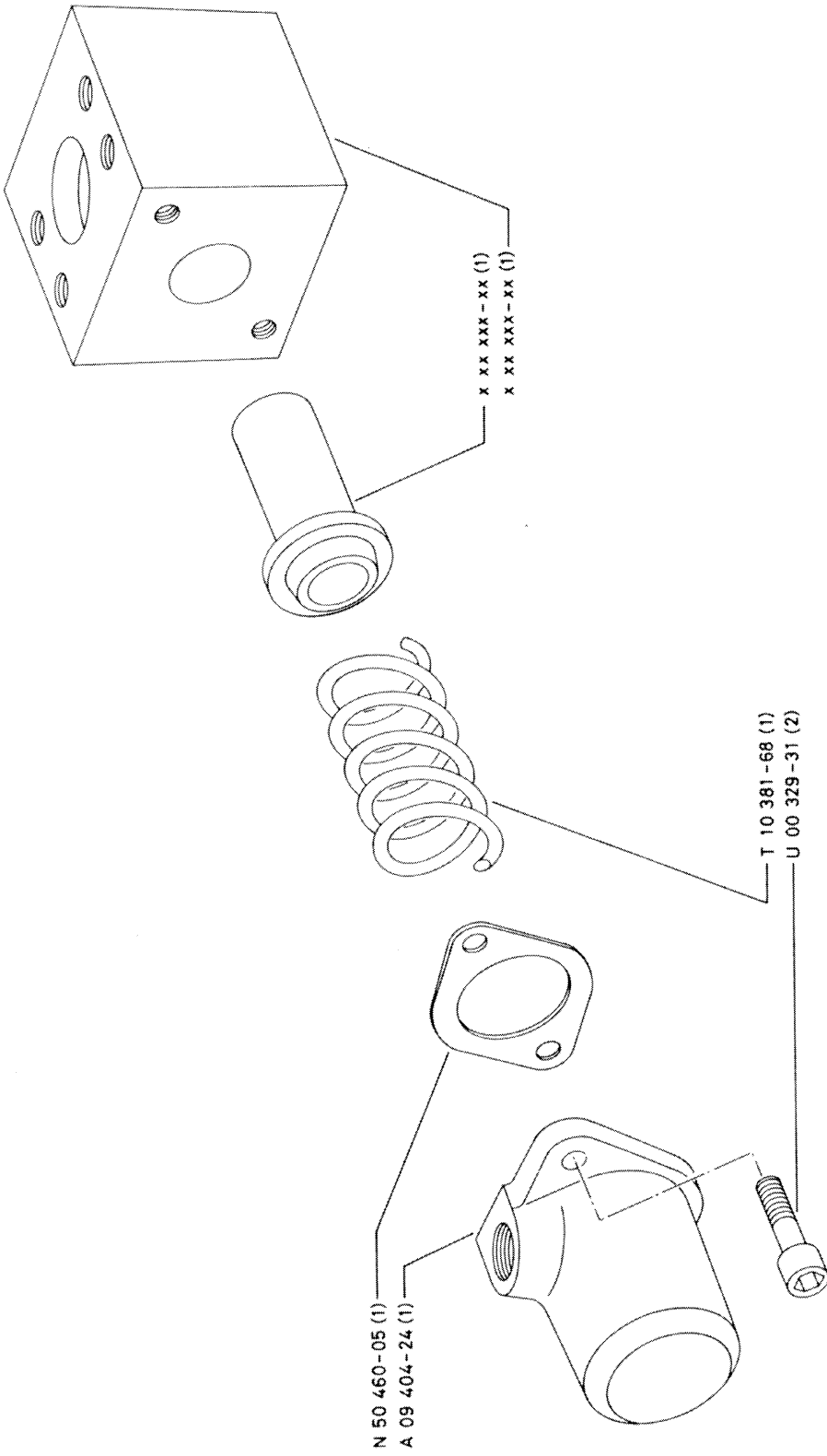

U11 433-71

SB25 F13

1-77

HM35 K07.0

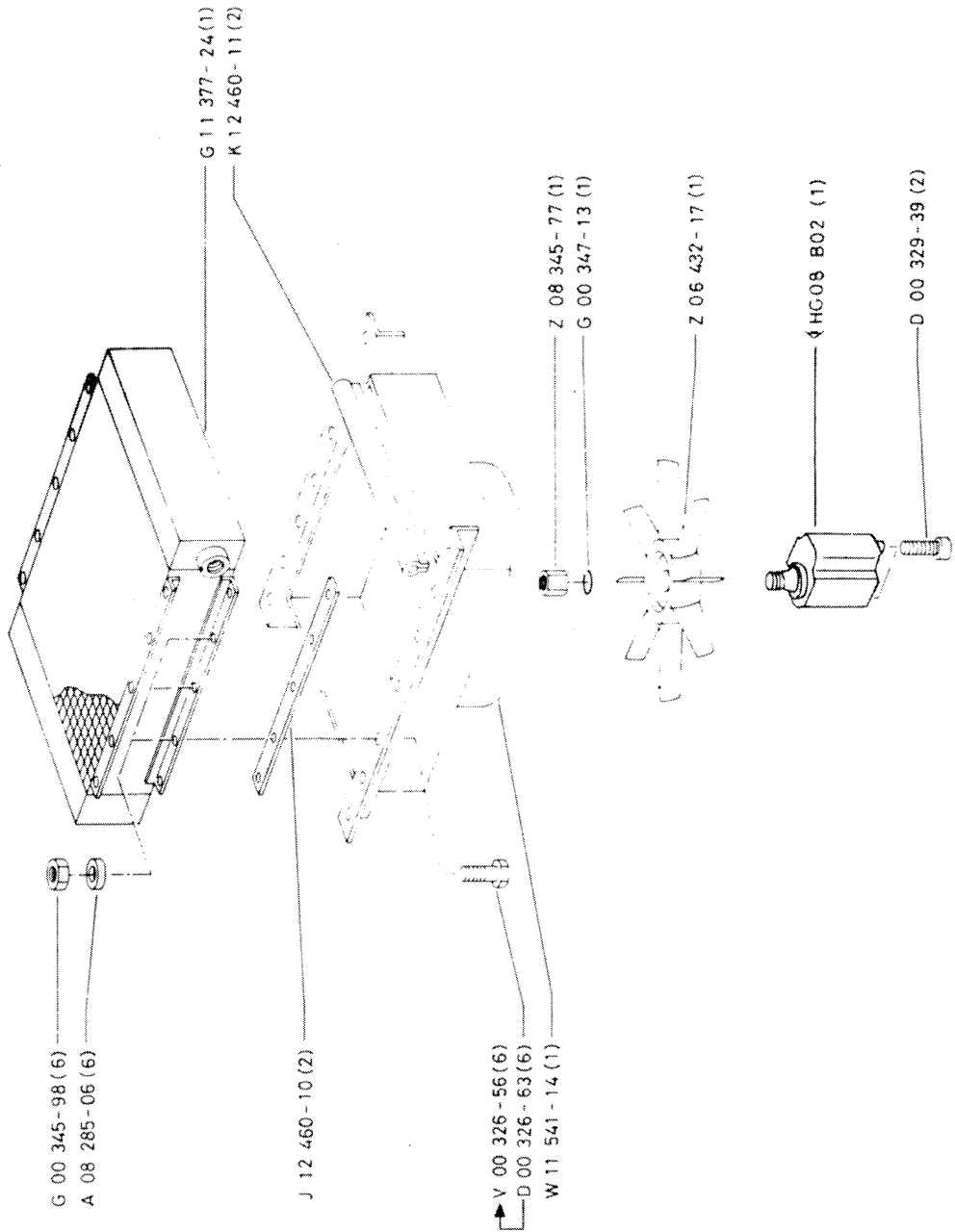

K 05 544-70

30 000 Kcal/h

7-76

HQ20 A01.1

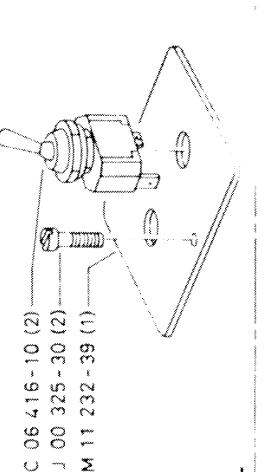
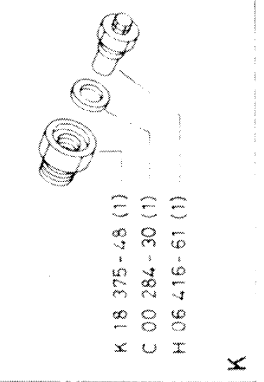
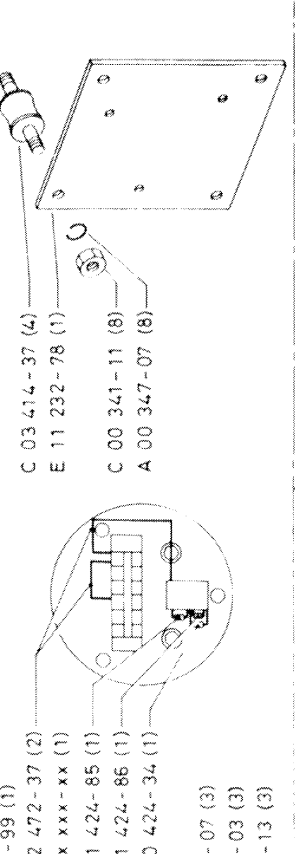
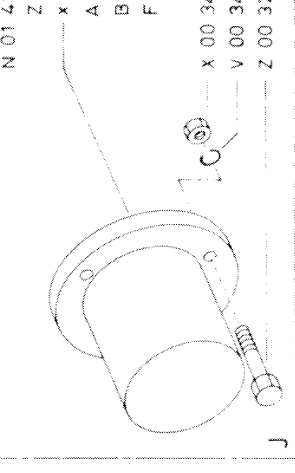
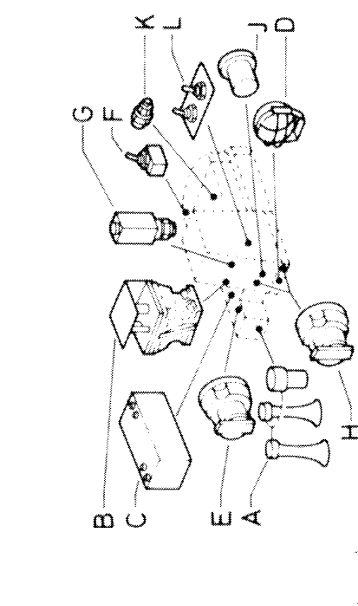
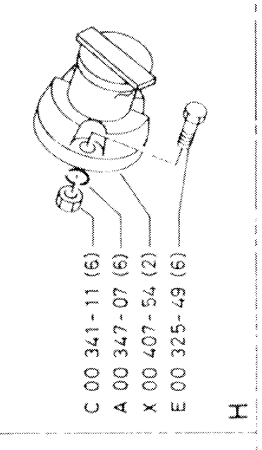
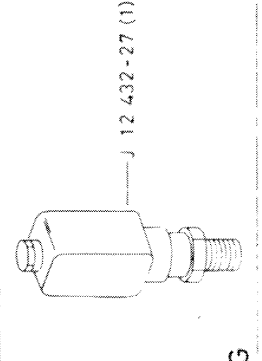
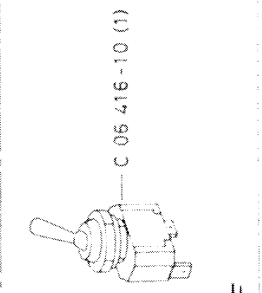
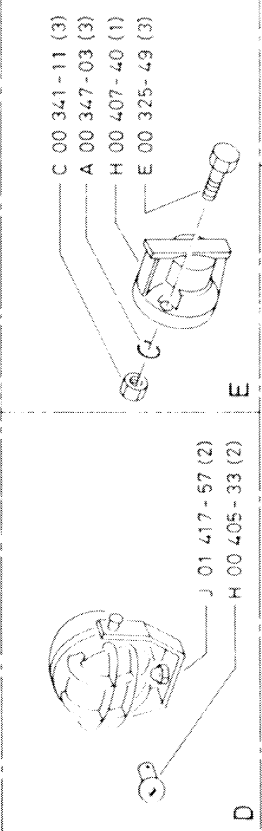
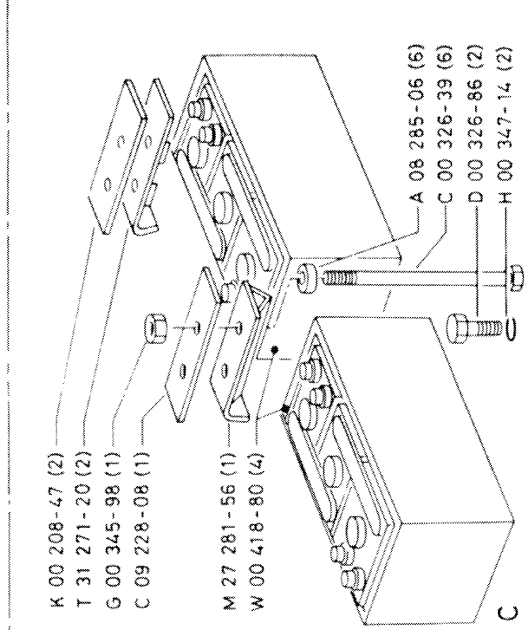
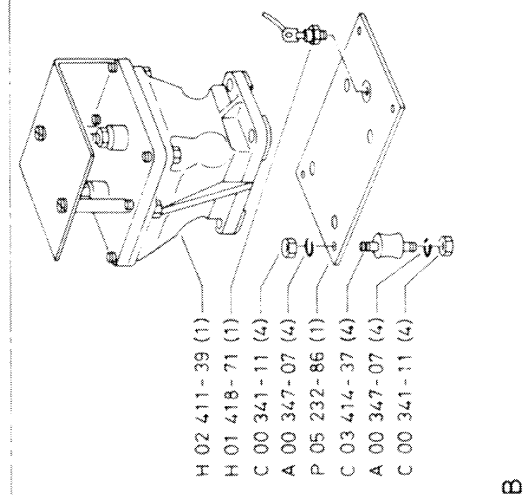
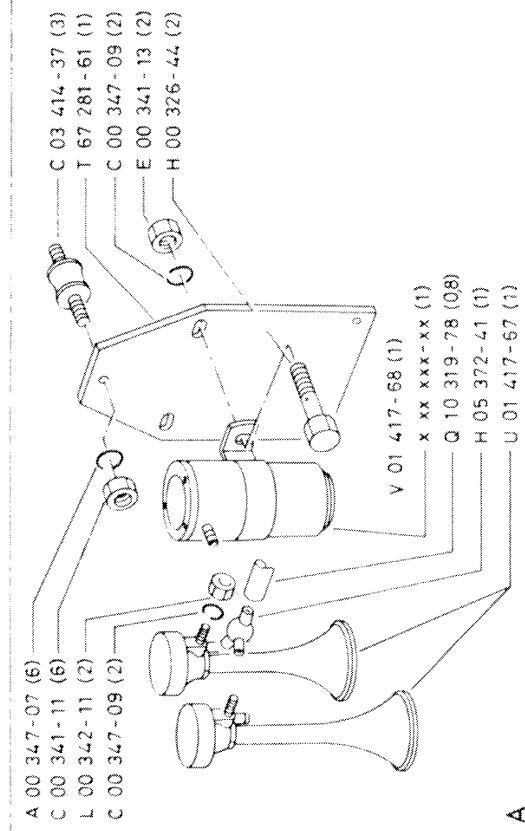

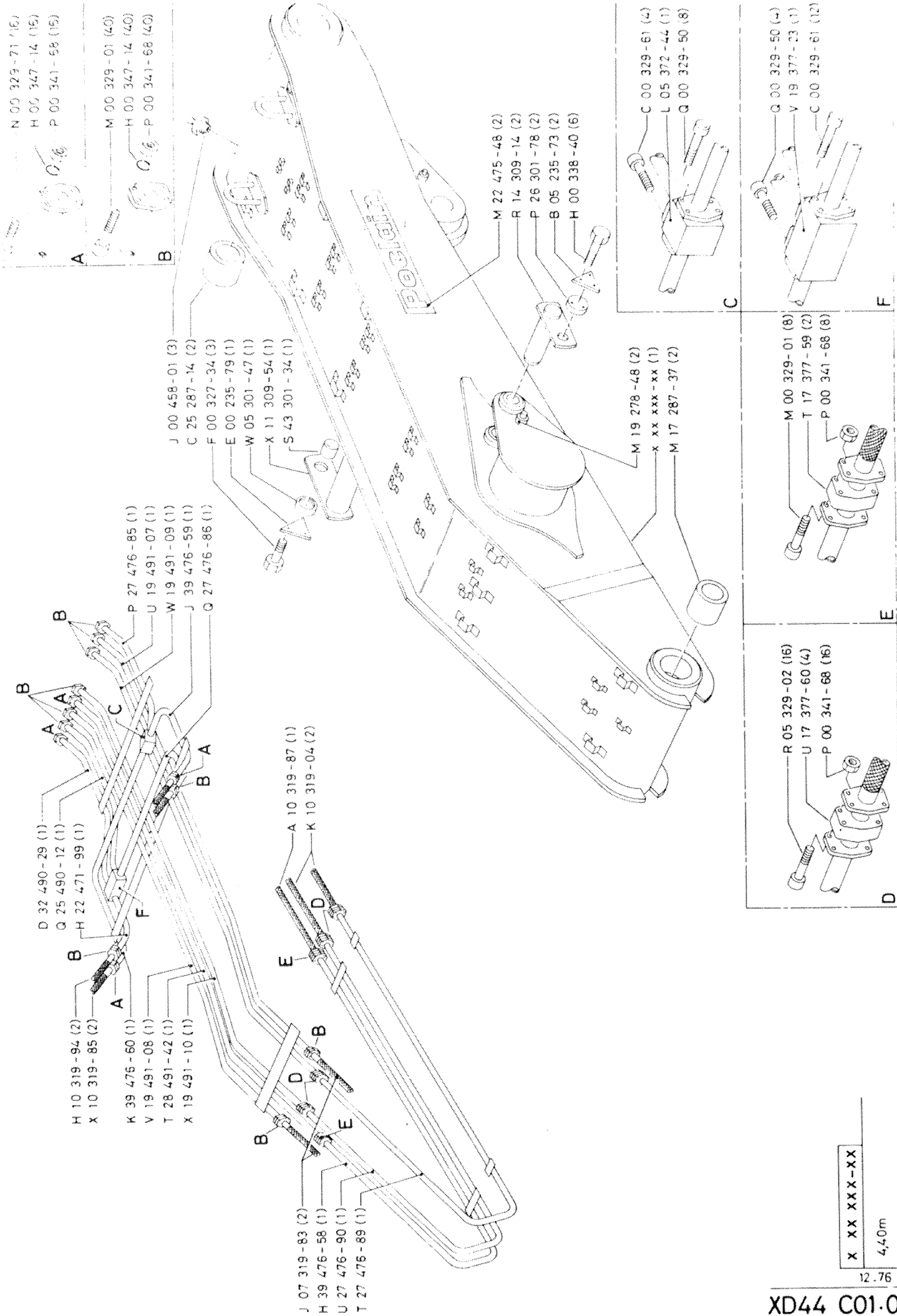

F

X XX XXX-XX  
4,40m

12.76

XD44 C01.0

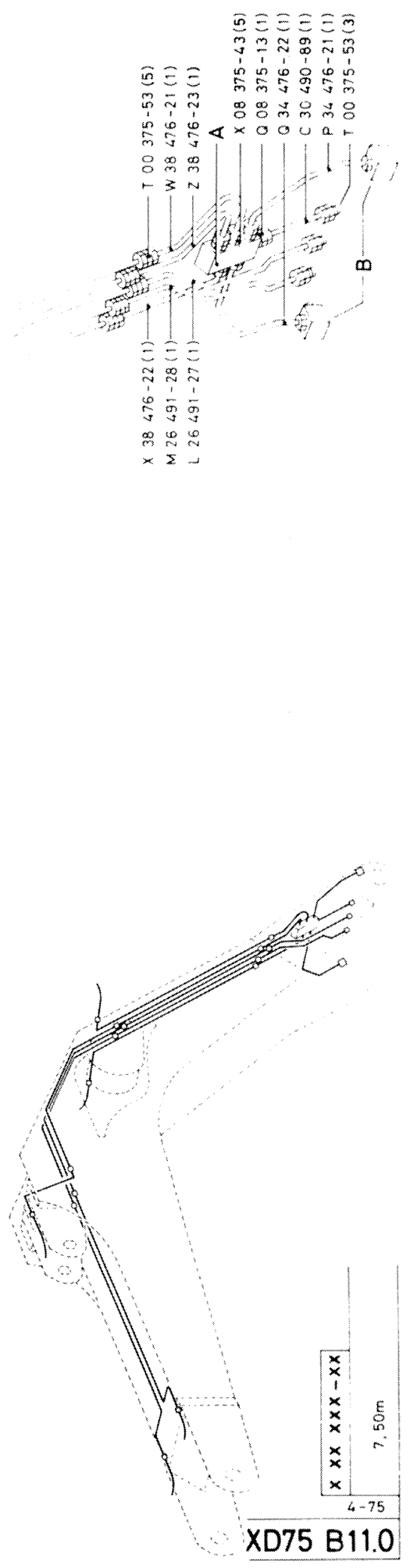
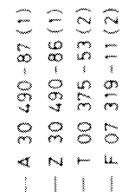
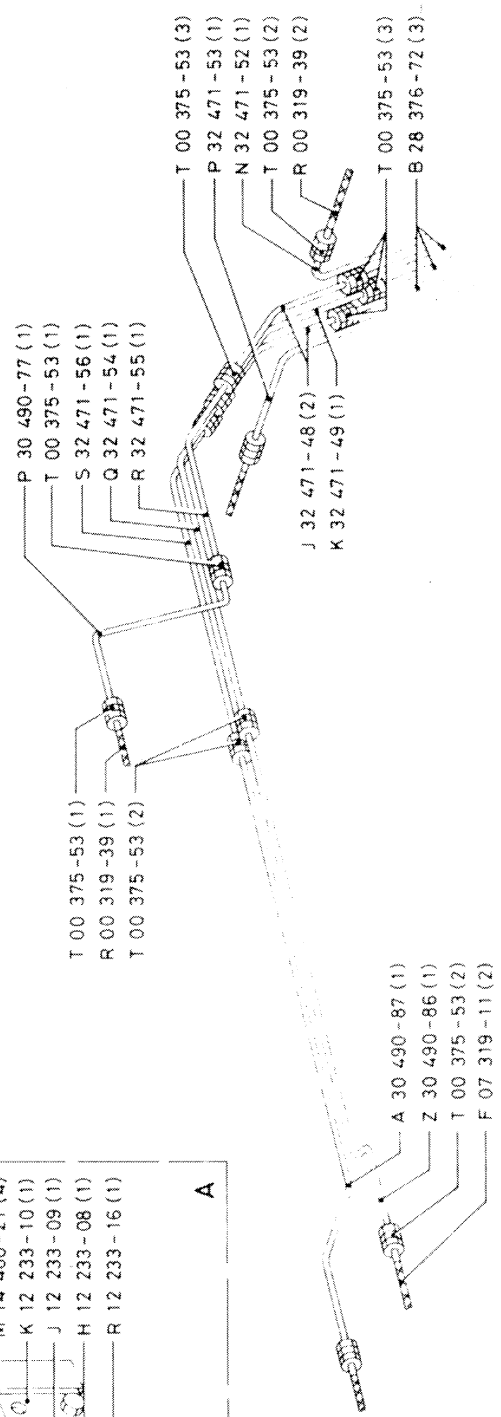
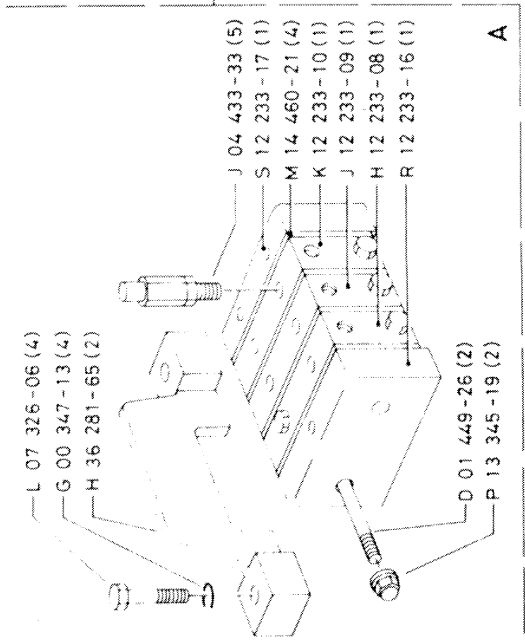
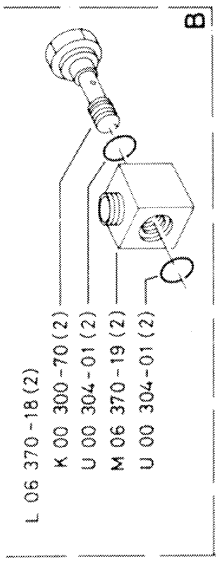

X XX XXX-XX  
 4-75  
 7,50m

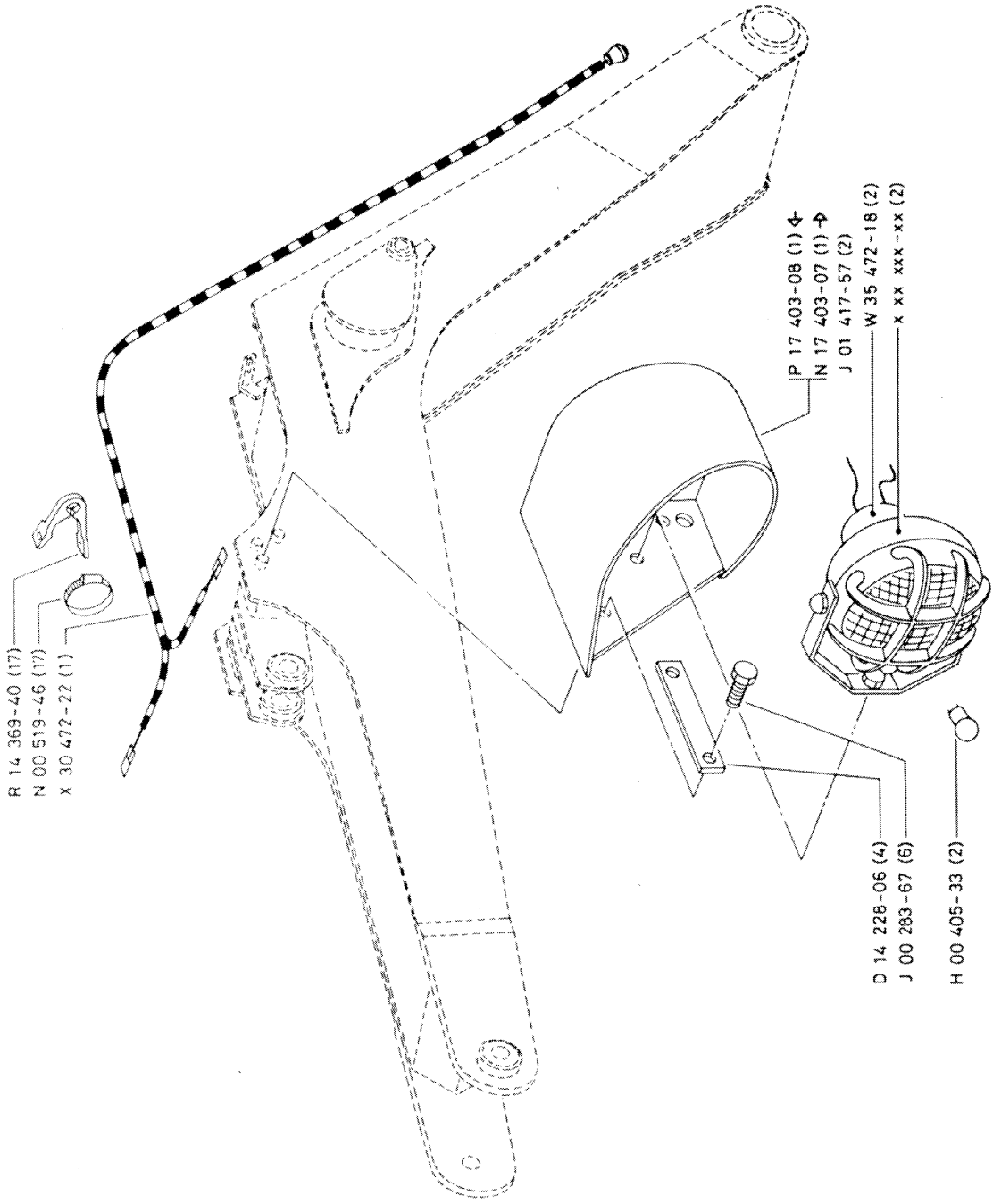

R 14 369-40 (17)  
 N 00 519-46 (17)  
 X 30 472-22 (1)

P 17 403-08 (1) ←  
 N 17 403-07 (1) →  
 J 01 417-57 (2)  
 W 35 472-18 (2)  
 X XX XXX-XX (2)

D 14 228-06 (4)  
 J 00 283-67 (6)  
 H 00 405-33 (2)

X XX XXX-XX

8,50m

1-77

**XD85 B31.0**

CLICK HERE TO **DOWNLOAD** THE COMPLETE MANUAL

- Thank you very much for reading the preview of the manual.
- You can download the complete manual from: [www.heydownloads.com](http://www.heydownloads.com) by clicking the link below



- Please note: If there is no response to CLICKING the link, please download this PDF first and then click on it.

CLICK HERE TO **DOWNLOAD** THE COMPLETE MANUAL