

Aspire 4935/4935G Series Service Guide

Service guide files and updates are available on the ACER/CSD web; for more information, please refer to <http://csd.acer.com.tw>

PRINTED IN TAIWAN

CLICK HERE TO **DOWNLOAD** THE COMPLETE MANUAL

- Thank you very much for reading the preview of the manual.
- You can download the complete manual from: www.heydownloads.com by clicking the link below



- Please note: If there is no response to CLICKING the link, please download this PDF first and then click on it.

CLICK HERE TO **DOWNLOAD** THE COMPLETE MANUAL

System Specifications

Features

Below is a brief summary of the computer's many feature:

NOTE: Items marked with * denote only selected models.

Operating System

- Genuine Windows® Vista™

Platform

- Intel® Centrino® 2 processor technology, featuring:
 - Intel® Core™ 2 Duo processor
 - Mobile Intel® PM45/GM45 Express Chipset*
 - Intel® Wireless WiFi Link 5100/5300*
 - Intel® Wireless WiFi Link 5150/5350*

System Memory

- Dual-Channel SDRAM support
- Up to 2 GB of DDR2 667 MHz memory, upgradeable to 4 GB using two soDIMM modules

Display and graphics

- 16:9 aspect ratio
- 14" HD 1366 x 768
- Mobile Intel® GM45 Express Chipset (for Aspire 4935)
- NVIDIA® GeForce® 9300M GS (for Aspire 4935G)

Storage subsystem

- 2.5" hard disk drive
- Optical drive option:
 - Blu-ray Disc™ /DVD-Super Multi double-layer drive*
 - DVD-Super Multi double-layer drive*
- 6-in-1 card reader

Audio

- Dolby®-optimized surround sound system with two built-in stereo speakers
- True5.1-channel surround sound output
- High-definition audio support
- S/PDIF (Sony/Philips Digital Interface) support for digital speakers
- Acer PureZone technology with two built-in stereo microphones
- MS-Sound compatible

Touchpad Basics (with fingerprint reader)

The following items show you how to use the touchpad with Acer Bio-Protection fingerprint reader:

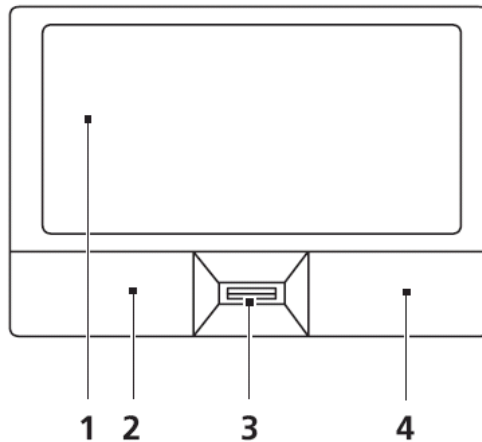

- Move your finger across the touchpad (1) to move the cursor.
- Press the left (2) and right (4) buttons located beneath the touchpad to perform selection and execution functions. These two buttons are similar to the left and right buttons on a mouse. Tapping on the touchpad is the same as clicking the left button.
- Use Acer Bio-Protection fingerprint reader (3) supporting Acer FingerNav 4-way control function (only for certain models) or the 4-way scroll (3) button (only for certain models) to scroll up or down and move left or right a page. This fingerprint reader or button mimics your cursor pressing on the right scroll bar of Windows applications.

| Function | Left Button (2) | Right Button (4) | Main touchpad (1) |
|---------------------|---|------------------|--|
| Execute | Quickly click twice. | | Tap twice (at the same speed as double-clicking a mouse button). |
| Select | Click once. | | Tap once. |
| Drag | Click and hold, then use finger on the touchpad to drag the cursor. | | Tap twice (at the same speed as double-clicking a mouse button); rest your finger on the touchpad on the second tap and drag the cursor. |
| Access context menu | | Click once. | |

NOTE: When using the touchpad, keep it - and your fingers - dry and clean. The touchpad is sensitive to finger movement; hence, the lighter the touch, the better the response. Tapping too hard will not increase the touchpad's responsiveness.

System Memory

| Item | Specifications |
|---------------------------------|--|
| Memory Controller | Onboard |
| Memory Size | 0MB (No on-board Memory) |
| DIMM socket number | 2 sockets |
| Supports Memory size per socket | 2 GB |
| Support maximum memory size | 4 GB for 64bit OS (with two 2GB SO-DIMM) |
| Support DIMM type | DDR II Synchronous DRAM |
| Support DIMM Speed | 667/800 MHz |
| Support DIMM voltage | 1.8V |
| Support DIMM package | 200-pin DDR II-667/800 SO-DIMM |
| Cache | 6MB L2 on CPU |
| VGA Memory | 512 MB with optional adjustable 128MB UMA VGA memory share from North Bridge |
| Memory module combinations | You can install memory modules in any combination as long as they match the above specifications |

Memory Combinations

| Slot 1 | Slot 2 | Total Memory |
|--------|--------|--------------|
| 0MB | 512MB | 512MB |
| 0MB | 1024MB | 1024MB |
| 0MB | 2048MB | 2048MB |
| 512MB | 512MB | 1024MB |
| 512MB | 1024MB | 1536MB |
| 512MB | 2048MB | 2560MB |
| 1024MB | 0MB | 1024MB |
| 1024MB | 512MB | 1536MB |
| 1024MB | 1024MB | 2048MB |
| 1024MB | 2048MB | 3072MB |
| 2048MB | 0MB | 2048MB |
| 2048MB | 512MB | 2560MB |
| 2048MB | 1024MB | 3072MB |
| 2048MB | 2048MB | 4096MB |

NOTE: Above table lists some system memory configurations. You may combine DIMMs with various capacities to form other combinations. On above table, the configuration of slot 1 and slot 2 could be reversed.

Main

The Main screen allows the user to set the system time and date as well as enable and disable boot option and recovery.

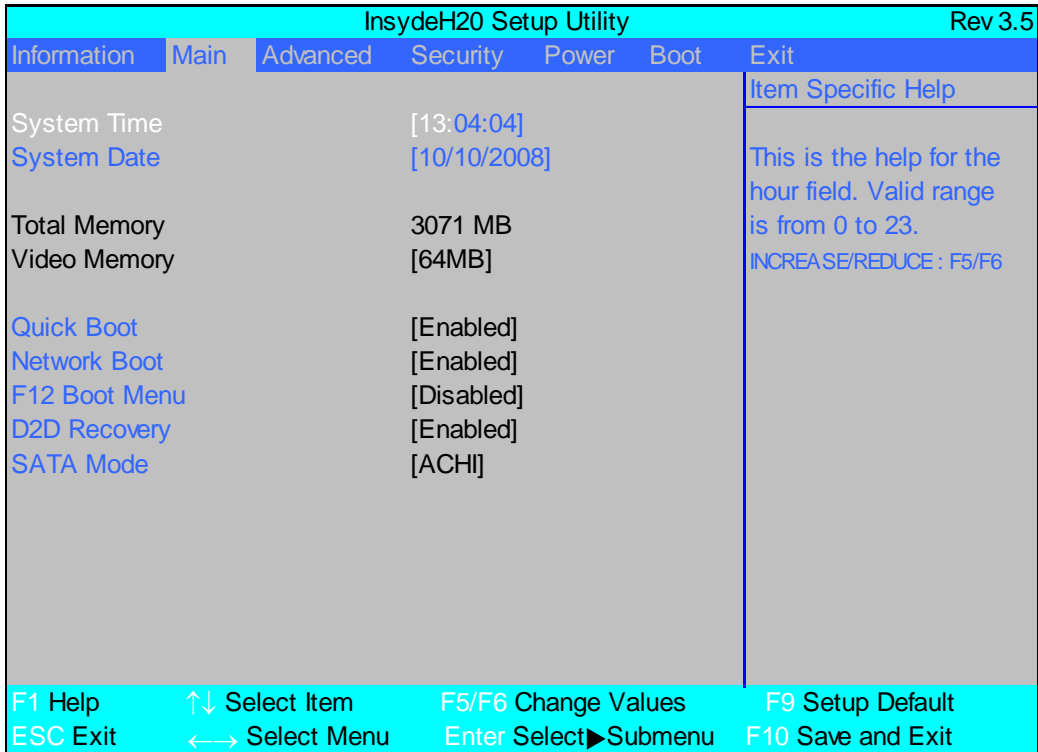

NOTE: The screen above is for your reference only. Actual values may differ.

The table below describes the parameters in this screen. Settings in **boldface** are the default and suggested parameter settings.

| Parameter | Description | Format/Option |
|---------------|---|---------------------------------------|
| System Time | Sets the system time. The hours are displayed with 24-hour format. | Format: HH:MM:SS (hour:minute:second) |
| System Date | Sets the system date. | Format MM/DD/YYYY (month/day/year) |
| Total Memory | This field reports the total memory size. Memory size is fixed to 3071 MB. | N/A |
| Video Memory | This field reports the video Memory size. | N/A |
| Quick Boot | Enables the boot sequence to skip some processes to boot up more quickly. | Option: Enabled or Disabled |
| Network Boot | Enables, disables the system boot from LAN (remote server). | Option: Enabled or Disabled |
| F12 Boot Menu | Enables or disables the Press <F12> to display boot menu message during startup. | Option: Enabled or Disabled |
| D2D Recovery | Enables, disables D2D Recovery function. The function allows the user to create a hidden partition on hard disc drive to store operation system and restore the system to factory defaults. | Option: Enabled or Disabled |
| SATA Mode | Control the mode in which the SATA controller should operate. | Option: ACHI or IDE |

Exit

The Exit screen allows you to save or discard any changes you made and quit the BIOS Utility.

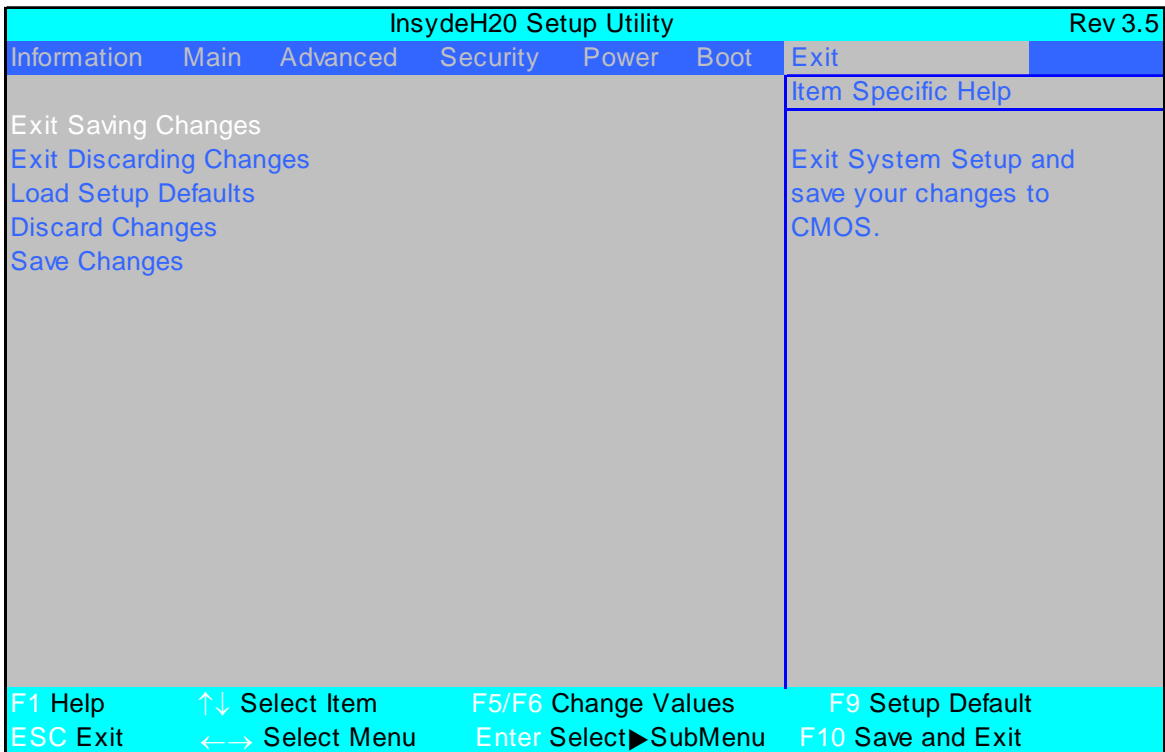

The table below describes the parameters in this screen.

| Parameter | Description |
|-------------------------|---|
| Exit Saving Changes | Exit System Setup and save your changes to CMOS. |
| Exit Discarding Changes | Exit utility without saving setup data to CMOS. |
| Load Setup Default | Load default values for all SETUP item. |
| Discard Changes | Load previous values from CMOS for all SETUP items. |
| Save Changes | Save Setup Data to CMOS. |

Machine Disassembly and Replacement

This chapter contains step-by-step procedures on how to disassemble the notebook computer for maintenance and troubleshooting.

Disassembly Requirements

To disassemble the computer, you need the following tools:

- Wrist grounding strap and conductive mat for preventing electrostatic discharge
- Flat screwdriver
- Philips screwdriver
- Plastic flat screwdriver
- Plastic tweezers

NOTE: The screws for the different components vary in size. During the disassembly process, group the screws with the corresponding components to avoid mismatch when putting back the components.

Removing the Hard Disk Drive Module

1. See “Removing the Lower Covers” on page 57.
2. Hold the Pull Tab and slide the HDD away from the connector.



3. Pull the HDD up as shown to remove.



NOTE: To prevent damage to HDD, avoid pressing down on it or placing heavy objects on top of it.

Removing the Function Board

1. See "Removing the Switch Cover" on page 68.
2. Remove the two securing screws from the Function Board.



| Step | Size | Quantity | Screw Type |
|----------------|--------|----------|---|
| Function Board | M2.5*3 | 2 |  |

3. Unlock the connector and remove the FFC cable.

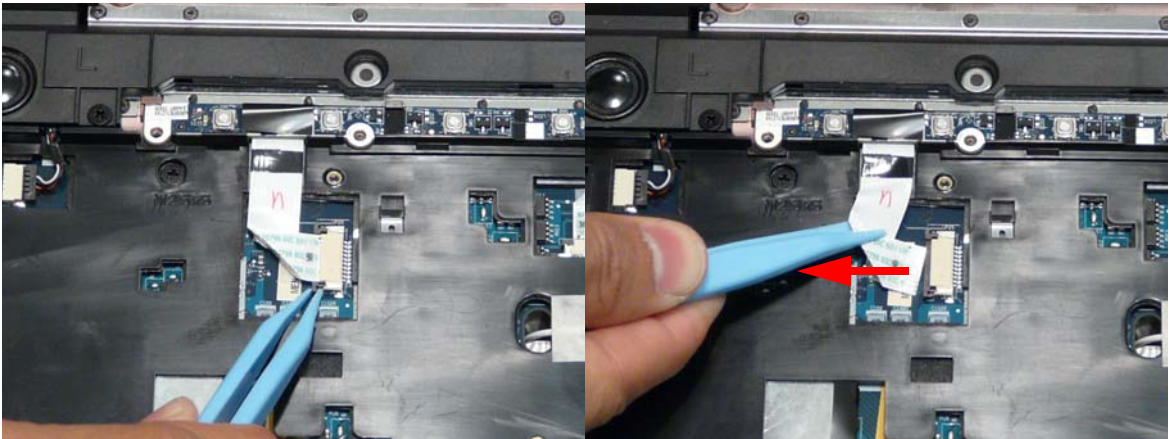

4. Rotate the board upward as shown and remove it from the chassis.

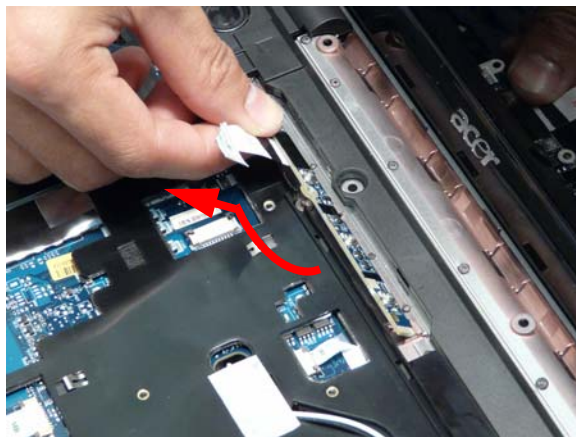

WARNING: Care must be taken when removing the Upper Base from the Lower Base to prevent damage or stress to the surface.

5. Ease the lower casing outward to clear the securing clips and pry apart the left side as shown, and lift the rear edge of the Upper Base upward.



6. Ease the lower casing outward to clear the securing clips and pry apart the right side as shown. Lift the rear edge of the Upper Base upward.



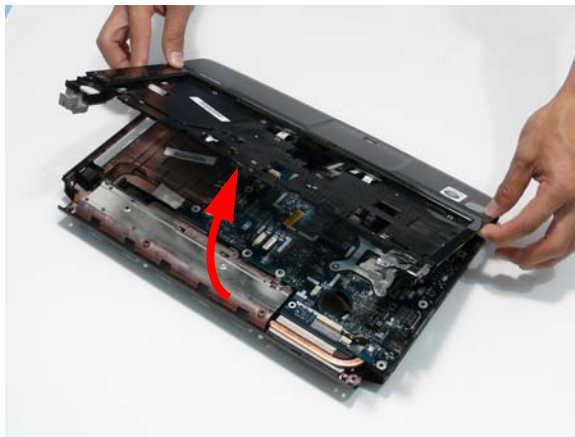

7. Completely remove the Upper Base from the Lower Base.

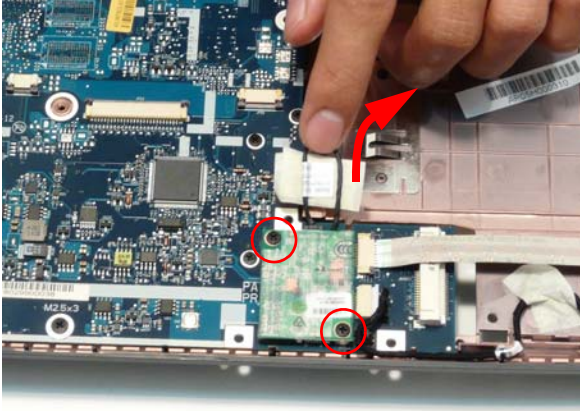

Removing the Modem Module

- 1. Remove the Upper Base. See “Removing the Upper Base” on page 79.
- 2. Remove the adhesive tape securing the cable to the Modem and remove the two securing screws.



| Step | Size | Quantity | Screw Type |
|--------------|------|----------|---|
| Modem Module | M2*3 | 2 |  |

- 3. Lift the Modem Module clear of the Mainboard as shown.

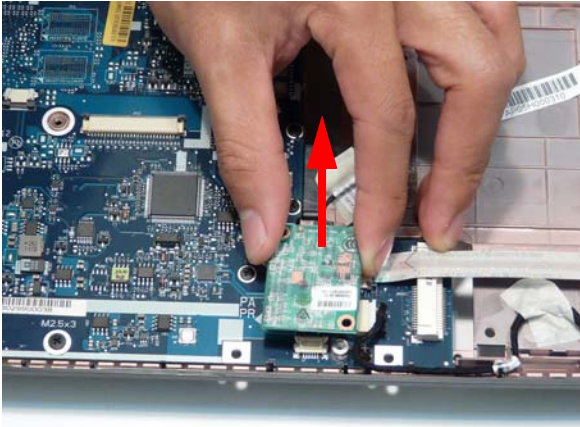

- 4. Turn the module over and disconnect the Modem cable. Remove the module from the casing.

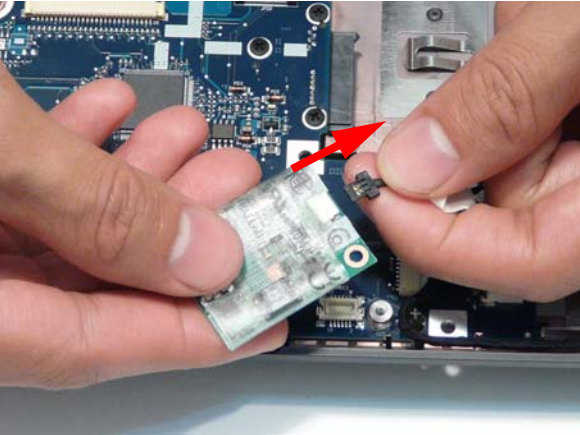

Removing the LCD Bezel

1. See "Removing the LCD Module" on page 74.
2. Remove the six screw caps and screws as shown.



| Step | Size | Quantity | Screw Type |
|-----------|--------|----------|---|
| LCD Bezel | M2.5*5 | 6 |  |

3. Starting at the centre of the top edge, pry the inside of the bezel away from the screen. Work round the edges to pry the bezel away from the screen as shown.



CLICK HERE TO **DOWNLOAD** THE COMPLETE MANUAL

- Thank you very much for reading the preview of the manual.
- You can download the complete manual from: www.heydownloads.com by clicking the link below



- Please note: If there is no response to CLICKING the link, please download this PDF first and then click on it.

CLICK HERE TO **DOWNLOAD** THE COMPLETE MANUAL

7. Run the left side Antenna cable as shown in the hinge well to avoid trapping.

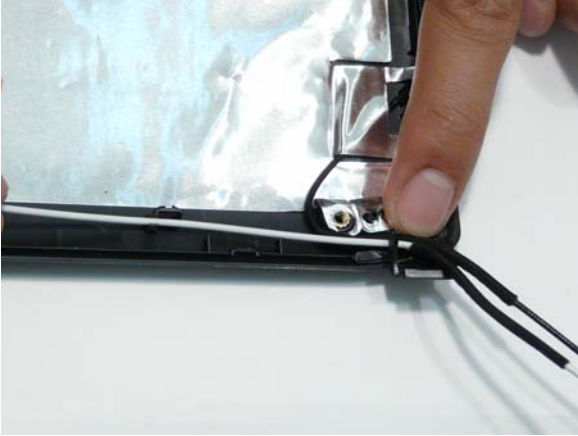

8. Run the cable along the edge of the casing using all available cable clips.

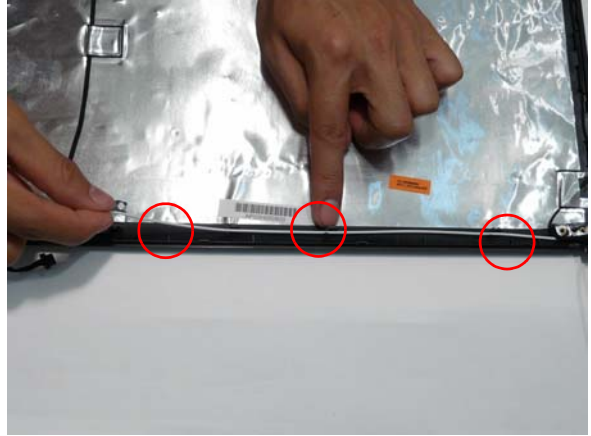

9. Run the cable as shown and replace the adhesive strip.

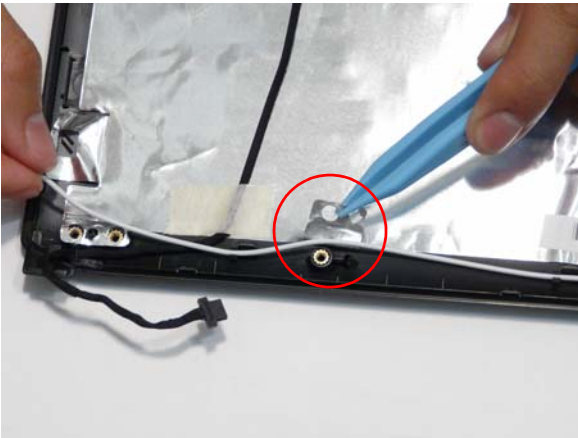

10. Run the cable as shown and replace the adhesive strip.

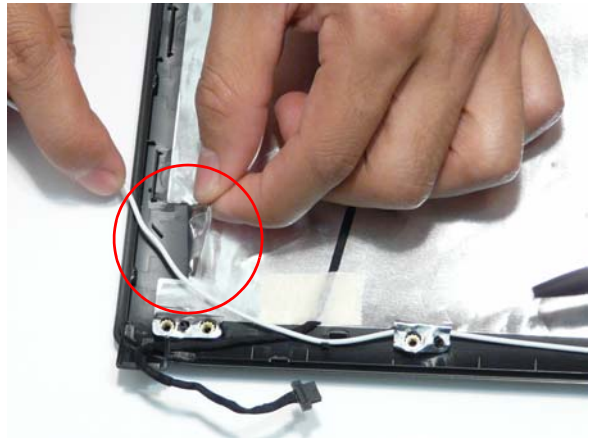

11. Run the cable along the edge of the casing using all available cable clips.

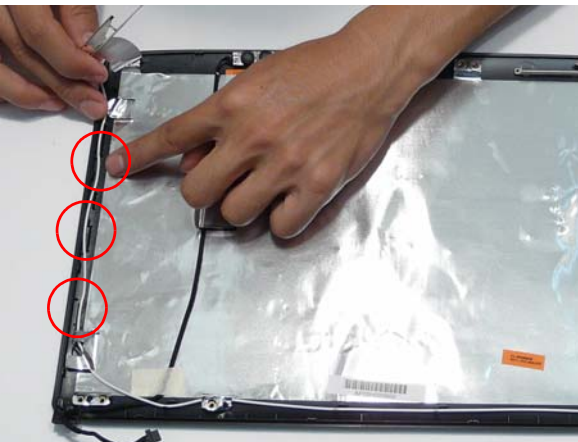

12. Replace the Antenna in the casing as shown and secure it in place with the tape.

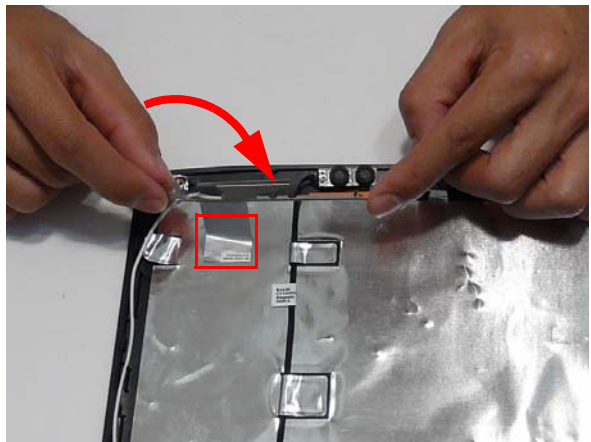

Replacing the Mainboard

1. Ensure that the Mainboard is face up. Place the Mainboard in the chassis, left hand edge first to allow the I/O Ports through the casing, then lower it into place.

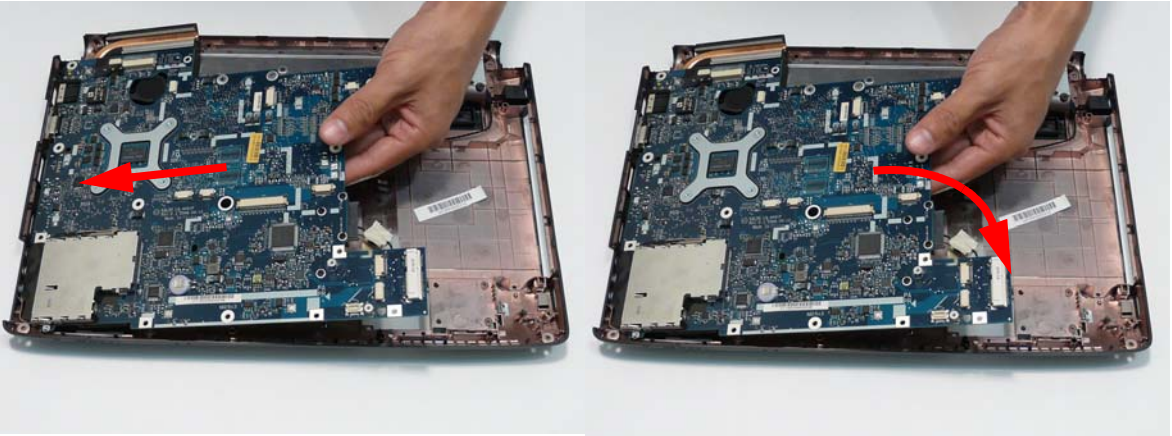

2. Ensure the screw socket is aligned. Replace the single securing screws as shown.

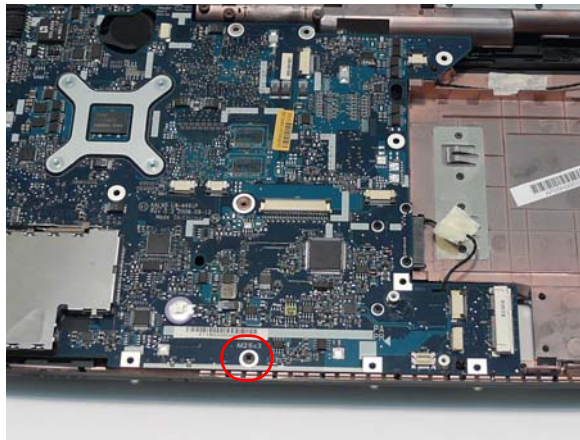

NOTE: Make sure the I/O ports are positioned correctly through the lower cover, and the screw sockets are visible through the mainboard.

3. Replace the RJ-11 cable in the retaining clip on the Mainboard.

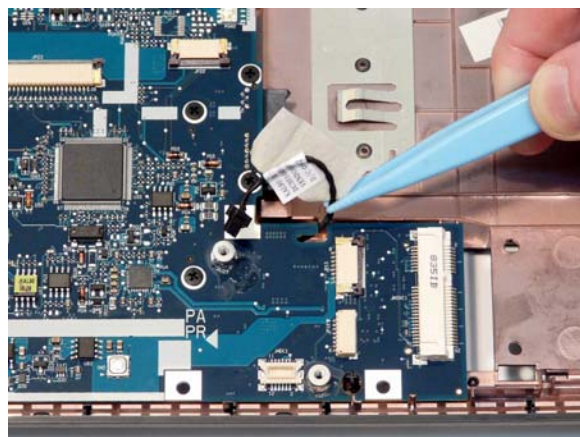

IMPORTANT: Run the cables as shown to avoid trapping when the Switch Cover is replaced.



6. Insert the Antenna cables through the casing, as shown, and pull through from the underside.

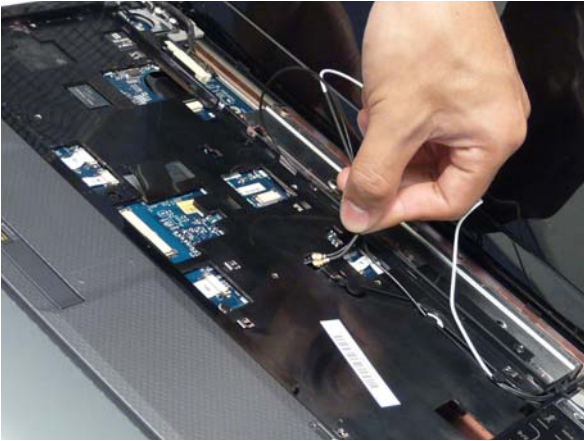

7. Ensure the cable is pulled completely through the casing.

8. Run the Antenna cables along the cable channel as shown, using all available cable clips.

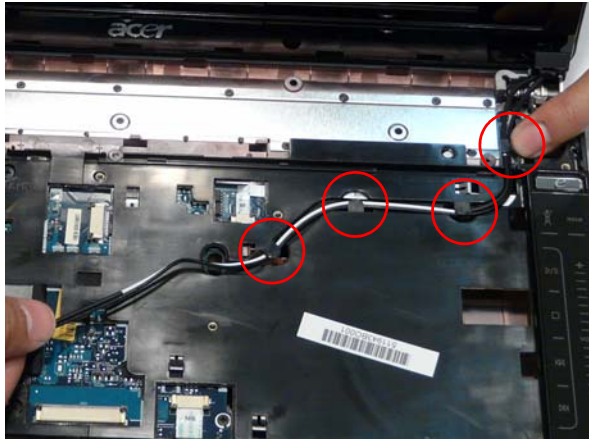
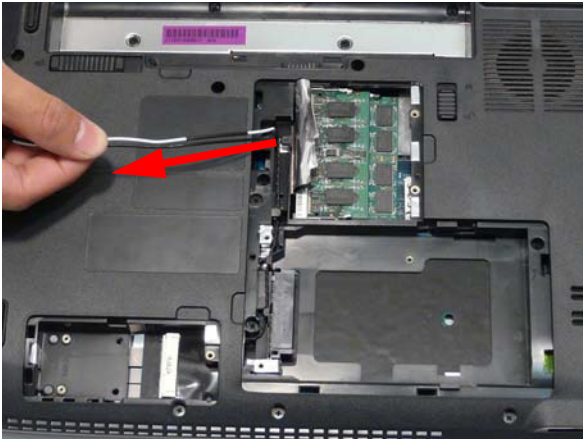

Replacing the Hard Disk Drive Module

1. Place the HDD carrier on the HDD.
2. Replace the four securing screws (two each side).

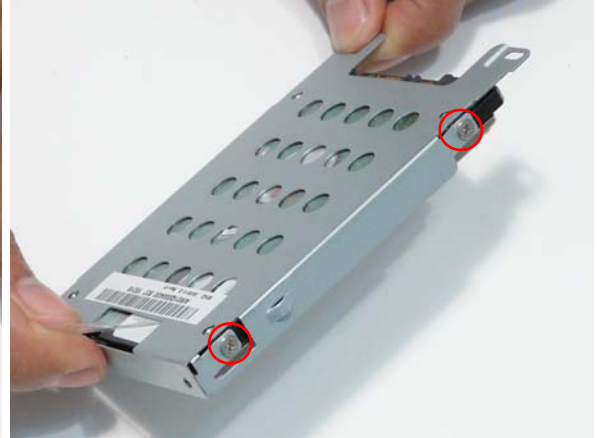

3. Place the HDD Module in the HDD bay as shown and slide it in the direction of the arrow to connect the interface.

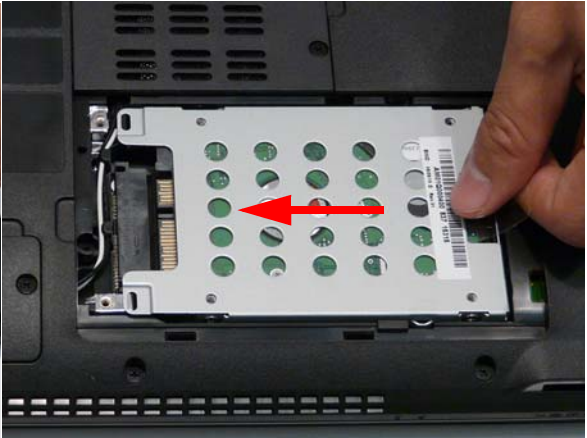
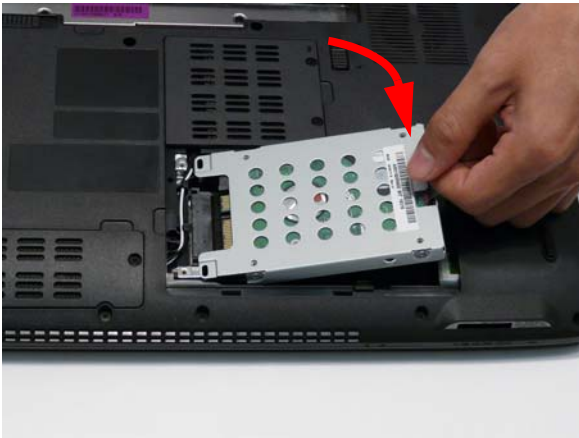

Replacing the DIMM Modules

NOTE: To replace DIMM Module 2, first remove DIMM Module 1. In this procedure, only DIMM Module 1 is shown.

1. Insert the DIMM Module flush with the connector and press down to lock in place.

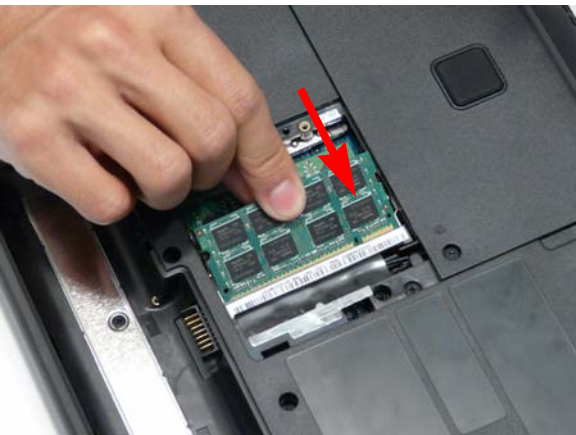

Sound Problems

If sound problems are experienced, perform the following actions one at a time to correct the problem.

1. Reboot the computer.
2. Navigate to **Start** → **Control Panel** → **System and Maintenance** → **System** → **Device Manager**. Check the Device Manager to determine that:
 - The device is properly installed.
 - There are no red Xs or yellow exclamation marks.
 - There are no device conflicts.
 - No hardware is listed under Other Devices.
3. Roll back the audio driver to the previous version, if updated recently.
4. Remove and reinstall the audio driver.
5. Ensure that all volume controls are set mid range:
 - a. Click the volume icon on the taskbar and drag the slider to 50. Ensure that the volume is not muted.
 - b. Click Mixer to verify that other audio applications are set to 50 and not muted.
6. Navigate to **Start** → **Control Panel** → **Hardware and Sound** → **Sound**. Ensure that Speakers are selected as the default audio device (green check mark).

NOTE: If Speakers does not show, right-click on the **Playback** tab and select **Show Disabled Devices** (clear by default).
7. Select Speakers and click **Configure** to start **Speaker Setup**. Follow the onscreen prompts to configure the speakers.
8. Remove and recently installed hardware or software.
9. Restore system and file settings from a known good date using **System Restore**.

If the issue is not fixed, repeat the preceding steps and select an earlier time and date.
10. Reinstall the Operating System.
11. If the Issue is still not resolved, see “Online Support Information” on page 229.

External Mouse Failure

If an external **Mouse** fails, perform the following actions one at a time to correct the problem.

1. Try an alternative mouse.
2. If the mouse uses a wireless connection, insert new batteries and confirm there is a good connection. See the mouse user manual.
3. If the mouse uses a USB connection, try an alternate USB port.
4. Try an alternative program to verify mouse operation. Reinstall the program experiencing mouse failure.
5. Restart the computer.
6. Remove any recently added hardware and associated software.
7. Remove any recently added software and reboot.
8. Restore system and file settings from a known good date using **System Restore**.
If the issue is not fixed, repeat the preceding steps and select an earlier time and date.
9. Run the Event Viewer to check the events log for errors. For more information see Windows Help and Support.
10. Roll back the mouse driver to the previous version if updated recently.
11. Remove and reinstall the mouse driver.
12. Check the Device Manager to determine that:
 - The device is properly installed. There are no red Xs or yellow exclamation marks.
 - There are no device conflicts.
 - No hardware is listed under Other Devices.
13. If the Issue is still not resolved, see "Online Support Information" on page 229.

Other Failures

If the CRT Switch, Dock, LAN Port, external MIC or Speakers, PCI Express Card, 5-in-1 Card Reader or Volume Wheel fail, perform the following general steps to correct the problem. Do not replace a non-defective FRUs:

1. Check Drive whether is OK.
2. Check Test Fixture is ok.
3. Swap M/B to Try.

Clearing Password Check and BIOS Recovery

This section provide you the standard operating procedures of clearing password and BIOS recovery for Aspire 4935/4935G. Aspire 4935/4935G provides one Hardware Open Gap on main board for clearing password check, and one Hotkey for enabling BIOS Recovery.

Clearing Password Check

Hardware Open Gap Description

| Item | Description | Location |
|-------|-------------------|------------|
| R1290 | Clear CMOS Jumper | Memory bay |



Steps for Clearing BIOS Password Check

If users set BIOS Password (Supervisor Password and/or User Password) for a security reason, BIOS will ask the password during systems POST or when systems enter to BIOS Setup menu. However, once it is necessary to bypass the password check, users need to short the HW Gap to clear the password by the following steps:

- Power Off a system, and remove HDD, AC and Battery from the machine.
- Open the back cover of the machine, and find out the HW Gap on M/B as picture.
- Use an electric conductivity tool to short the two points of the HW Gap.
- Plug in AC, keep the short condition on the HW Gap, and press Power Button to power on the system till BIOS POST finish. Then remove the tool from the HW Gap.
- Restart system. Press F2 key to enter BIOS Setup menu.
- If there is no Password request, BIOS Password is cleared. Otherwise, please follow the steps and try again.

NOTE: The steps are only for clearing BIOS Password (Supervisor Password and User Password).

| Category | Description | Acer P/N |
|---|---|--------------|
|  | CAMERA BRACKET | 33.AD302.006 |
| Mainboard | | |
|  | MB ASSY W/O CPU/RAM-UMA | MB.AD302.001 |
| | MB ASSY 256MB W/O CPU/RAM-DIS | TBD |
| | MB ASSY 512MB W/O CPU/RAM-DIS | MB.AC902.001 |
| Memory | | |
|  | RAM 512M DDRII 667 SAMSUNG M470T6464QZ3-CE6 | KN.5120B.026 |
| | RAM 512M DDRII 667 HYNIX HYMP164S64CP6-Y5 | KN.5120G.024 |
| | RAM 1G DDRII 667 NANYA NT1GT64UH8D0FN-3C | KN.1GB03.026 |
| | RAM 1G DDRII 667 SAMSUNG M470T2864QZ3-CE6 | KN.1GB0B.016 |
| | RAM 1G DDRII 667 ELPIDA EBE11UE6ACUA-6E-E | KN.1GB09.008 |
| | RAM 1G DDRII 667 HYNIX HYMP112S64CP6-Y5 | KN.1GB0G.012 |
| | RAM 2G DDRII 667 HYNIX HYMP125S64CP8-Y5 | KN.2GB0G.004 |
| | RAM 2G DDRII 667 SAMSUNG M470T5663QZ3-CE6 | KN.2GB0B.003 |
| | RAM 2G DDRII 667 NANYA NT2GT64U8HD0BN-3C | KN.2GB03.011 |
| RAM 2G DDRII 667 ELPIDA EBE21UE8ACUA-6E-E | KN.2GB09.001 | |
| Heatsink | | |
|  | CPU THERMAL MODULE-DIS | 60.AC702.001 |
| | CPU THERMAL MODULE-UMA | 60.AD302.007 |
| Speaker | | |
|  | SPEAKER | 23.AD302.001 |
|  | DIGITAL MIC | 23.AD302.002 |
| Miscellaneous | | |
| | NAME PLATE-AS4935 | 47.AD302.001 |

| Model | RO | Country | Acer Part No | Description | CPU |
|-----------------|-------|-----------------|--------------|--|----------|
| AS4935-731G16Mn | PA | ACLA-Portuguese | LX.AD30X.037 | AS4935-731G16Mn EM VHP32ATXC2 MC UMACE 1*1G/160/6L/6R/ CB_n2_1.0D_HG_XC21 | C2DP7350 |
| AS4935-731G16Mn | PA | ACLA-Spanish | LX.AD30X.036 | AS4935-731G16Mn EM VHP32ATEA3 MC UMACE 1*1G/160/6L/6R/ CB_n2_1.0D_HG_ES22 | C2DP7350 |
| AS4935-731G16Mn | PA | ACLA-Spanish | LX.AD30X.035 | AS4935-731G16Mn VHP32ATEA1 MC UMACE 1*1G/160/6L/6R/ CB_n2_1.0D_HG_ES21 | C2DP7350 |
| AS4935-731G25Mn | CHINA | China | LX.AC60C.004 | AS4935-731G25Mn LINPUSACN1 UMACEF 1*1G/250/6L/6R/ CB_n2_FP_1.0D_HG_EN91 | C2DP7350 |
| AS4935-731G25Mn | CHINA | China | LX.AC60Y.001 | AS4935-731G25Mn VHB32ATCN1 MC UMACEF 1*1G/250/6L/6R/ CB_n2_FP_1.0D_HG_SC11 | C2DP7350 |
| AS4935-732G25Mn | AAP | Vietnam | LX.AC60C.003 | AS4935-732G25Mn LINPUSAVN1 UMACEF 1*2G/250/BT/6L/6R/ CB_n2_FP_1.0D_HG_EN11 | C2DP7350 |
| AS4935-733G25Mn | PA | Canada | LX.AC60X.009 | AS4935-733G25Mn VHP32ATCA2 MC UMACEF 2G+1G/250/6L/6R/ CB_n2_FP_1.0D_HG_FR31 | C2DP7350 |
| AS4935-733G25Mn | PA | Canada | LX.AC60X.010 | AS4935-733G25Mn VHP32ATCA2 MC UMACEF 2G+1G/250/6L/6R/ CB_n2_FP_1.0D_HG_FR33 | C2DP7350 |
| AS4935-733G25Mn | PA | USA | LX.AC60X.011 | AS4935-733G25Mn VHP32ATUS1 MC UMACEF 2G+1G/250/6L/6R/ CB_n2_FP_1.0D_HG_EN32 | C2DP7350 |
| AS4935-733G25Mn | PA | USA | LX.AC60X.012 | AS4935-733G25Mn VHP32ATUS1 MC UMACEF 2G+1G/250/6L/6R/ CB_n2_FP_1.0D_HG_EN33 | C2DP7350 |
| AS4935-733G25Mn | PA | ACLA-Portuguese | LX.AC60X.008 | AS4935-733G25Mn EM VHP32ATXC2 MC UMACEF 2G+1G/250/6L/6R/ CB_n2_FP_1.0D_HG_XC21 | C2DP7350 |
| AS4935-733G25Mn | PA | ACLA-Portuguese | LX.AC60X.006 | AS4935-733G25Mn VHP32ATXC2 MC UMACEF 2G+1G/250/6L/6R/ CB_n2_FP_1.0D_HG_XC22 | C2DP7350 |
| AS4935-733G25Mn | PA | ACLA-Spanish | LX.AC60X.007 | AS4935-733G25Mn EM VHP32ATEA1 MC UMACEF 2G+1G/250/6L/6R/ CB_n2_FP_1.0D_HG_ES22 | C2DP7350 |

| Model | RO | Country | Acer Part No | Description | CPU |
|------------------|-------|-----------------|--------------|---|----------|
| AS4935G-863G25Mn | PA | USA | LX.AC90X.008 | AS4935G-863G25Mn VHP32ATUS1 MC 9MGSHM512CE 2G+1G/250/ 6L/6R/CB_n2_1.0D_HG_EN33 | C2DP8600 |
| AS4935G-863G25Mn | PA | ACLA-Portuguese | LX.AC90X.009 | AS4935G-863G25Mn EM VHP32ATXC2 MC 9MGSHM512CE 2G+1G/250/ 6L/6R/CB_n2_1.0D_HG_XC21 | C2DP8600 |
| AS4935G-863G25Mn | PA | ACLA-Portuguese | LX.AC90X.010 | AS4935G-863G25Mn VHP32ATXC2 MC 9MGSHM512CE 2G+1G/250/ 6L/6R/CB_n2_1.0D_HG_XC22 | C2DP8600 |
| AS4935G-863G25Mn | PA | ACLA-Spanish | LX.AC90X.007 | AS4935G-863G25Mn EM VHP32ATEA1 MC 9MGSHM512CE 2G+1G/250/ 6L/6R/CB_n2_1.0D_HG_ES22 | C2DP8600 |
| AS4935G-863G25Mn | PA | ACLA-Spanish | LX.AC90X.006 | AS4935G-863G25Mn EM VHP32ATEA3 MC 9MGSHM512CE 2G+1G/250/ 6L/6R/CB_n2_1.0D_HG_ES22 | C2DP8600 |
| AS4935G-863G25Mn | PA | ACLA-Spanish | LX.AC90X.005 | AS4935G-863G25Mn VHP32ATEA1 MC 9MGSHM512CE 2G+1G/250/ 6L/6R/CB_n2_1.0D_HG_ES21 | C2DP8600 |
| AS4935G-863G32Mn | AAP | Indonesia | LX.AD80X.026 | AS4935G-863G32Mn EM VHP32ATID1 MC 9MGSHM512CEF 2G+1G/320/ BT/6L/6R/ CB_n2_FP_1.0D_HG_ID24 | C2DP8600 |
| AS4935G-864G32Bn | AAP | Thailand | LX.AD80X.016 | AS4935G-864G32Bn VHP32ATTH1 MC 9MGSHM512CEF 2*2G/320/ BT/6L/6R/ CB_n3_FP_1.0D_HG_TH21 | C2DP8600 |
| AS4935G-864G32Mn | AAP | Singapore | LX.AC90X.004 | AS4935G-864G32Mn VHP32ATSG1 MC 9MGSHM512CE 2*2G/320/BT/ 6L/6R/CB_N_1.0D_HG_ZH31 | C2DP8600 |
| AS4935G-864G32Mn | AAP | Singapore | LX.AD80X.014 | AS4935G-864G32Mn VHP32ATSG1 MC 9MGSHM512CEF 2*2G/320/ BT/6L/6R/ CB_n3_FP_1.0D_HG_ZH31 | C2DP8600 |
| AS4935G-864G32Mn | TWN | GCTWN | LX.AD80X.006 | AS4935G-864G32Mn VHP32ATTW1 MC 9MGSHM512CEF 2*2G/320/ BT/6L/6R/ CB_n2_FP_1.0D_HG_TC11 | C2DP8600 |
| AS4935G-864G32Mn | CHINA | China | LX.AD80X.001 | AS4935G-864G32Mn VHP32ATCN1 MC 9MGSHM512CEF 2*2G/320/ BT/6L/6R/ CB_n2_FP_1.0D_HG_SC11 | C2DP8600 |

| Model | LCD | VGA Chip | VRAM 1 | Memory 1 | Memory 2 |
|------------------|-------------|----------|---------------------|----------|----------|
| AS4935G-733G32Mn | NLED14WXGAG | 9MGSHM | 512M-DDR2(64*16*4) | SO2GBII6 | SO1GBII6 |
| AS4935G-733G32Mn | NLED14WXGAG | 9MGSHM | 512M-DDR2(64*16*4) | SO2GBII6 | SO1GBII6 |
| AS4935G-733G32Mn | NLED14WXGAG | 9MGSHM | 512M-DDR2(64*16*4) | SO2GBII6 | SO1GBII6 |
| AS4935G-733G32Mn | NLED14WXGAG | 9MGSHM | 512M-DDR2(64*16*4) | SO2GBII6 | SO1GBII6 |
| AS4935G-841G16Mn | NLED14WXGAG | 9MGSHM | 512M-DDR2(64*16*4) | SO1GBII6 | N |
| AS4935G-842G16Mn | NLED14WXGAG | 9MGSHM | 256M-DDR2 (32*16*4) | SO1GBII6 | SO1GBII6 |
| AS4935G-842G25Mn | NLED14WXGAG | 9MGSHM | 512M-DDR2(64*16*4) | SO2GBII6 | N |
| AS4935G-842G32Mn | NLED14WXGAG | 9MGSHM | 512M-DDR2(64*16*4) | SO2GBII6 | N |
| AS4935G-842G32Mn | NLED14WXGAG | 9MGSHM | 512M-DDR2(64*16*4) | SO2GBII6 | N |
| AS4935G-862G25Mn | NLED14WXGAG | 9MGSHM | 512M-DDR2(64*16*4) | SO2GBII6 | N |
| AS4935G-863G25Mn | NLED14WXGAG | 9MGSHM | 512M-DDR2(64*16*4) | SO2GBII6 | SO1GBII6 |
| AS4935G-863G25Mn | NLED14WXGAG | 9MGSHM | 512M-DDR2(64*16*4) | SO2GBII6 | SO1GBII6 |
| AS4935G-863G25Mn | NLED14WXGAG | 9MGSHM | 512M-DDR2(64*16*4) | SO2GBII6 | SO1GBII6 |
| AS4935G-863G25Mn | NLED14WXGAG | 9MGSHM | 512M-DDR2(64*16*4) | SO2GBII6 | SO1GBII6 |
| AS4935G-863G25Mn | NLED14WXGAG | 9MGSHM | 512M-DDR2(64*16*4) | SO2GBII6 | SO1GBII6 |
| AS4935G-863G25Mn | NLED14WXGAG | 9MGSHM | 512M-DDR2(64*16*4) | SO2GBII6 | SO1GBII6 |
| AS4935G-863G25Mn | NLED14WXGAG | 9MGSHM | 512M-DDR2(64*16*4) | SO2GBII6 | SO1GBII6 |
| AS4935G-863G25Mn | NLED14WXGAG | 9MGSHM | 512M-DDR2(64*16*4) | SO2GBII6 | SO1GBII6 |
| AS4935G-863G25Mn | NLED14WXGAG | 9MGSHM | 512M-DDR2(64*16*4) | SO2GBII6 | SO1GBII6 |
| AS4935G-863G32Mn | NLED14WXGAG | 9MGSHM | 512M-DDR2(64*16*4) | SO2GBII6 | SO1GBII6 |
| AS4935G-864G32Bn | NLED14WXGAG | 9MGSHM | 512M-DDR2(64*16*4) | SO2GBII6 | SO2GBII6 |
| AS4935G-864G32Mn | NLED14WXGAG | 9MGSHM | 512M-DDR2(64*16*4) | SO2GBII6 | SO2GBII6 |
| AS4935G-864G32Mn | NLED14WXGAG | 9MGSHM | 512M-DDR2(64*16*4) | SO2GBII6 | SO2GBII6 |
| AS4935G-864G32Mn | NLED14WXGAG | 9MGSHM | 512M-DDR2(64*16*4) | SO2GBII6 | SO2GBII6 |
| AS4935G-864G32Mn | NLED14WXGAG | 9MGSHM | 512M-DDR2(64*16*4) | SO2GBII6 | SO2GBII6 |

| Model | HDD 1(GB) | ODD | Card Reader | WLAN | BT | Finger Print |
|------------------|-------------|----------|-----------------|----------|--------|--------------|
| AS4935G-863G25Mn | N250GB5.4KS | NSM8XS | 6 in 1-Build in | SP1x2MMW | N | N |
| AS4935G-863G25Mn | N250GB5.4KS | NSM8XS | 6 in 1-Build in | SP1x2MMW | N | N |
| AS4935G-863G25Mn | N250GB5.4KS | NSM8XS | 6 in 1-Build in | SP1x2MMW | N | N |
| AS4935G-863G25Mn | N250GB5.4KS | NSM8XS | 6 in 1-Build in | SP1x2MMW | N | N |
| AS4935G-863G32Mn | N320GB5.4KS | NSM8XS | 6 in 1-Build in | SP1x2MMW | BT 2.0 | AES1610 |
| AS4935G-864G32Bn | N320GB5.4KS | NBDCB2XS | 6 in 1-Build in | SP3x3MMW | BT 2.0 | AES1610 |
| AS4935G-864G32Mn | N320GB5.4KS | NSM8XS | 6 in 1-Build in | SP3x3MMW | BT 2.0 | N |
| AS4935G-864G32Mn | N320GB5.4KS | NSM8XS | 6 in 1-Build in | SP3x3MMW | BT 2.0 | AES1610 |
| AS4935G-864G32Mn | N320GB5.4KS | NSM8XS | 6 in 1-Build in | SP1x2MMW | BT 2.0 | AES1610 |
| AS4935G-864G32Mn | N320GB5.4KS | NSM8XS | 6 in 1-Build in | SP1x2MMW | BT 2.0 | AES1610 |
| AS4935G-864G32Mn | N320GB5.4KS | NSM8XS | 6 in 1-Build in | SP3x3MMW | BT 2.0 | AES1610 |
| AS4935G-864G50Bn | N500GB5.4KS | NBDCB2XS | 6 in 1-Build in | SP3x3MMW | BT 2.0 | AES1610 |
| AS4935G-864G50Mn | N500GB5.4KS | NSM8XS | 6 in 1-Build in | SP3x3MMW | BT 2.0 | AES1610 |
| AS4935G-942G25Mn | N250GB5.4KS | NSM8XS | 6 in 1-Build in | SP1x2MMW | N | N |
| AS4935G-944G32Bn | N320GB5.4KS | NBDCB2XS | 6 in 1-Build in | SP3x3MMW | BT 2.0 | AES1610 |
| AS4935G-944G32Mn | N320GB5.4KS | NSM8XS | 6 in 1-Build in | SP3x3MMW | BT 2.0 | N |
| AS4935G-944G50Mn | N500GB5.4KS | NSM8XS | 6 in 1-Build in | SP3x3MMW | BT 2.0 | AES1610 |
| AS4935G-952G25Mn | N250GB5.4KS | NSM8XS | 6 in 1-Build in | SP1x2MMW | N | AES1610 |
| AS4935G-954G32Bn | N320GB5.4KS | NBDCB2XS | 6 in 1-Build in | SP3x3MMW | BT 2.0 | N |
| AS4935G-964G32Bn | N320GB5.4KS | NBDCB2XS | 6 in 1-Build in | SP3x3MMW | BT 2.0 | N |

CLICK HERE TO **DOWNLOAD** THE COMPLETE MANUAL

- Thank you very much for reading the preview of the manual.
- You can download the complete manual from: www.heydownloads.com by clicking the link below



- Please note: If there is no response to CLICKING the link, please download this PDF first and then click on it.

CLICK HERE TO **DOWNLOAD** THE COMPLETE MANUAL