

# RP 86 "Reach Plus"

Featuring "Electro-Proportional"  
Control System

## ILLUSTRATED PARTS CATALOG

FOR MACHINE  
SERIAL NUMBER

---

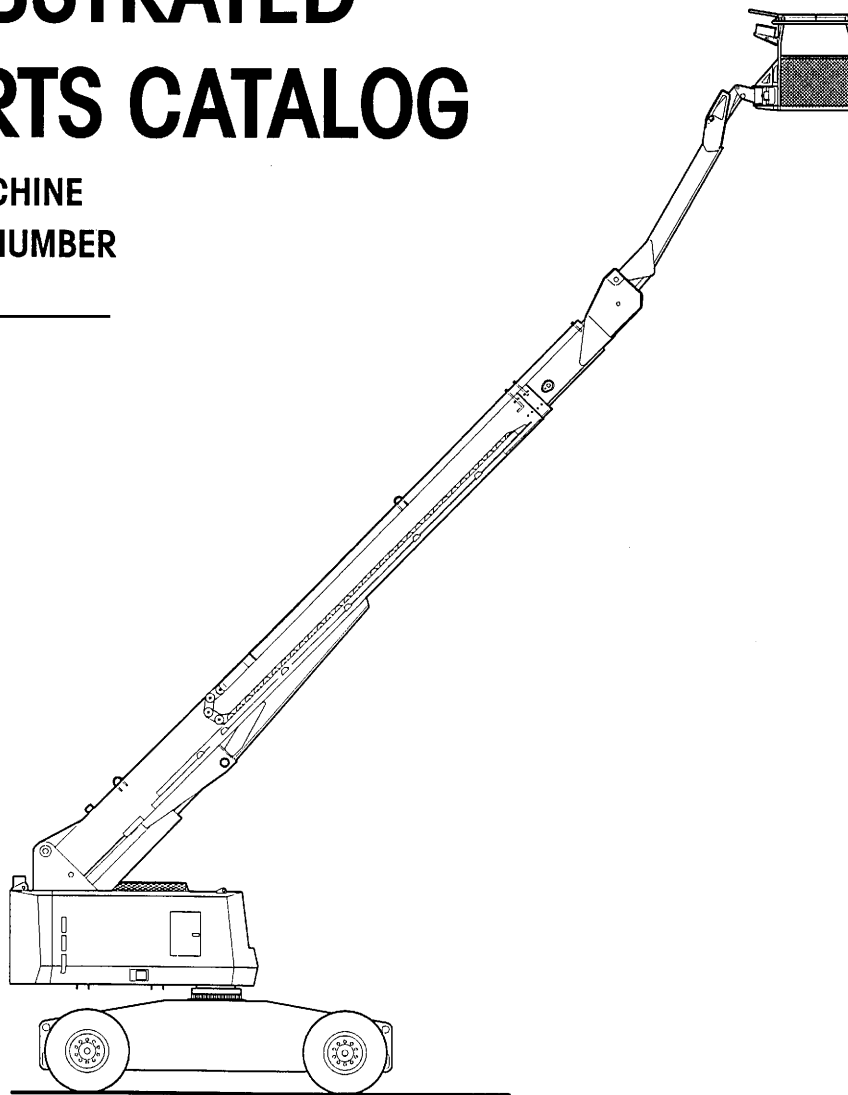

Art # A00.00179E

Part No. 89-186005 • Revision 0.1 dated June, 1996 •

CLICK HERE TO **DOWNLOAD** THE COMPLETE MANUAL

- Thank you very much for reading the preview of the manual.
- You can download the complete manual from: [www.heydownloads.com](http://www.heydownloads.com) by clicking the link below



- Please note: If there is no response to CLICKING the link, please download this PDF first and then click on it.

CLICK HERE TO **DOWNLOAD** THE COMPLETE MANUAL

## PARTS LIST

ITEM	PART NO	SEE SECTION	DESCRIPTION	QTY.
57	354 5750 354 5810	C13.201 C13.202	FRONT (STEER) AXLE ASSEMBLY For <b>Two Wheel Drive</b> versions (Standard) For <b>Four Wheel Drive</b> versions (Optional)	1
58	354 3590	C13.249	TIE ROD ASSEMBLY	1
59	07-090008		CAP SCREW, HEX HEAD (1"-8 x 3-1/2", Grade 8)	2
60	07-047124		NUT, HEX JAM (1"-14, Grade 5)	2
61	07-004154		CAP SCREW, HEX HEAD (3/4"-10 x 3-1/4", Grade 8)	8
62	07-004152		CAP SCREW, HEX HEAD (3/4"-10 x 2-3/4", Grade 8)	8
63	07-065022		WASHER, HELICAL LOCK (3/4")	16
64	07-061022		WASHER, FLAT (3/4", SAE, hardened)	16
65	235 8600		SHIM, AXLE MOUNTING (Side) (2.0" x 4.5" [51 x 114 mm]) .375" (9.5 mm) thick	A.R.
	235 8610		.250" (6.4 mm) thick	
	235 8620		12 Ga (.1046" [2.6 mm] thick)	
	235 8630		16 Ga (.0598" [1.5 mm] thick)	
66	354 2910	C13.203	REAR (DRIVE) AXLE ASSEMBLY <b>Without</b> Four Wheel Steering (Standard)	1
67			HOSE KIT, UNDERCARRIAGE	1
	354 3040 354 3030		For <b>Two Wheel Drive</b> versions (Standard) For <b>Four Wheel Drive</b> versions (Optional)	
			The following items <b>are not</b> included with the Undercarriage Assembly:	
68	235 9200		COVER, AXLE HOUSING (Top)	1
69	235 3030		COVER, AXLE HOUSING (Side)	4
70	07-050014		NUT, LOCK (1/4"-20, Grade 5)	20
71	07-062014		WASHER, FLAT (1/4")	20
72	235 7730		COVER, UNDERCARRIAGE ACCESS (Side)	2
73	235 3510		COVER, UNDERCARRIAGE ACCESS (Top, Front)	1
74	235 3520		COVER ASSEMBLY, UNDERCARRIAGE ACCESS (Top, rear)	1
75	235 3480		COVER, UNDERCARRIAGE ACCESS	1
76	235 3460		DOOR, AXLE CONTROLS ACCESS	1
77	10-095600		HINGE, ACCESS DOOR	2
78	07-097000		CAP SCREW, BUTTON HEAD (1/4"-20 x 3/4", Stainless steel)	8
79	07-050014		NUT, LOCK (1/4"-20, Grade 5)	8
80	10-267400		LATCH, ACCESS DOOR	1
81	07-044014		NUT, ACORN (1/4"-20, low crown, stainless steel)	24
82	07-062014		WASHER, FLAT (1/4")	24

TITLE **UNDERCARRIAGE ASSEMBLY, RP 86 AND T-80**

SECTION **B01.** | PLATE NO. **203** | PAGE **03** | REV. **A** | DATED **29 MAY, 1996** | PART NO.



Simon Aerials Inc.  
10600 West Brown Deer Road  
Milwaukee Wisconsin 53224 USA  
Parts Phone 1-800-47-SIMON  
24 Hr (Machine) 414-362-8280  
Fax 414-355-3172

## PARTS LIST

ITEM	PART NO	SEE SECTION	DESCRIPTION	QTY.
			SUPERSTRUCTURE ASSEMBLY (Continued)	
60	07-003128		CAP SCREW, HEX HEAD (5/8"-11 x 1-3/4", Grade 5)	5
61	07-061021		WASHER, FLAT (5/8", SAE)	10
62	07-050021		NUT, STOP (5/8"-11)	5
63			TRAY ASSEMBLY, TANK SIDE	1
	354 4801		Current version (for all except machines listed below)	
	354 4800		Earlier version (for RP 86 S/N AXA 00147, AXA 00148 and AUA 00155 only)	
64	235 0520		TRAY, TANK SIDE	1
65	See Plate . . .	C11.05	FUEL TANK ASSEMBLY	1
66	See Plate . . .	C10.06	HYDRAULIC TANK ASSEMBLY	1
67	07-003086		CAP SCREW, HEX HEAD (1/2"-13 x 1-1/4", Grade 5)	8
68	07-062018		WASHER, FLAT (1/2")	16
69	07-058400		NUT, STOP (1/2"-13)	8
70	See Plate . . .	D07.101	EMERGENCY PUMP	1
71	06-044600		90° ELBOW, "O"-RING TO 37° (6 C50X-S)	2
72	06-079000		CONNECTOR, SWIVEL NUT (6 F650X-S)	1
73	01-226000		FILTER ASSEMBLY (Screw-on)	1
74	01-226001		ELEMENT, FILTER	1
75	06-096100		UNION (6 F50F50-S)	1
76	01-020800		VALVE, POPPET CHECK (3 psi [.207 bar])	1
77	06-040100		ADAPTER, "O"-RING TO 37° (8 F50X-S)	1
78	10-138500		BUMPER, RECESSED (Rubber, 1" dia. x 1.2" high)	2
79			CAP SCREW, HEX HEAD (1/4"-20, Grade 5)	2
80	07-040014		NUT, HEX (1/4"-20, Grade 5)	2
81	07-047014		NUT, HEX JAM (1/4"-20, Grade 5)	2

TITLE **SUPERSTRUCTURE ASSEMBLY, RP 86 AND T-80**

SECTION **B02.** | PLATE NO. **203** | PAGE **03** | REV. **A** | DATED **24 JUN., 1996** | PART NO.



Simon Aerials Inc.  
 10600 West Brown Deer Road  
 Milwaukee Wisconsin 53224 USA  
 Parts Phone 1-800-47-SIMON  
 24 Hr (Machine) 414-362-8280  
 Fax 414-355-3172

## PARTS LIST

ITEM	PART NO	SEE SECTION	DESCRIPTION	QTY.
197	236 0740 235 4970		FRAME, DOOR (Tank side) For current style doors, using adjustable hinges For earlier style doors, using continuous hinge (see insert)	1
198	236 0750 235 3190		FRAME, DOOR (Engine side) For current style doors, using adjustable hinges For earlier style doors, using continuous hinge (see insert)	1
199	07-004094		CAP SCREW, HEX HEAD (1/2"-13 x 3-1/4", Grade 8)	12
200	07-065018		WASHER, HELICAL LOCK (1/2")	12
201	07-062018		WASHER, FLAT (1/2")	12
202	235 3440		HINGE, SUPERSTRUCTURE DOOR (earlier continuous style)	2
203	236 0590		HINGE ASSEMBLY, SUPERSTRUCTURE DOOR (current adjustable style)	4
204	236 0640		HINGE SECTION (Door half)	1
205	236 0720		HINGE SECTION ASSEMBLY (Frame half, with pin)	1
206	236 0600		PAD, HINGE ADJUSTMENT (for pin section)	1
207	236 0630		HINGE SECTION (Frame half, with socket for pin)	1
208	236 0610		PAD, HINGE ADJUSTMENT (for socket section)	1
209	07-003025		CAP SCREW, HEX HEAD (5/16"-18 x 1", Grade 5)	2
210	07-062015		WASHER, FLAT (5/16")	2
211	07-065015		WASHER, HELICAL LOCK (5/16")	2
212			CAP SCREW, HEX HEAD (5/16"-18, Grade 5) For current style doors, using adjustable hinges	8
213	07-017030		For earlier style doors, using continuous hinge (see insert) CAP SCREW, BUTTON HEAD (5/16"-18 x 2-1/4", Grade 5) For current style doors, using adjustable hinges	34 8
214	07-062015		For earlier style doors, using continuous hinge (see insert) WASHER, FLAT (5/16") For current style doors, using adjustable hinges	34 16
215	07-065015		For earlier style doors, using continuous hinge (see insert) WASHER, HELICAL LOCK (5/16") For current style doors, using adjustable hinges	68 8
216	07-050015		For earlier style doors, using continuous hinge (see insert) NUT, STOP (5/16"-18, Grade 5) For current style doors, using adjustable hinges	34 8
217	236 0210		For earlier style doors, using continuous hinge (see insert) SHIM, DOOR FRAME (for earlier style, continuous hinge)	34 A.R.
218	236 0500		WEAR STRIP (Upper, 11" [279 mm] long)	1
219	236 0510		WEAR STRIP (Lower, 7" [178 mm] long)	1

TITLE **SUPERSTRUCTURE ASSEMBLY, RP 86 AND T-80**

SECTION **B02.** | PLATE NO. **203** | PAGE **08** | REV. **A** | DATED **24 JUN., 1996** | PART NO.





## PARTS LIST

ITEM	PART NO	SEE SECTION	DESCRIPTION	QTY.
1	354 2690		PLATFORM GROUP (36" x 60" [.91 M x 1.52 M]) <b>Standard</b> , with mesh screen on lower half	1
2			PLATFORM ASSEMBLY (36" x 60" [.91 M x 1.52 M]) <b>Standard</b> , with mesh screen on lower half	1
3	354 2680		PLATFORM WELDMENT (36" x 60" [.91 M x 1.52 M]) <b>Standard</b> , with mesh screen on lower half	1
	234 9660		<b>Optional</b> , with full height mesh screen	
	236 0520		<b>Optional</b> , for use with "self-closing" gate	
	236 0530 235 5030		<b>Optional</b> , with "Pinch Guard" outer top rail. See illustration.	
4	02-042700	D24.201	ACTUATOR, PLATFORM ROTARY	1
5	06-039800		ADAPTER, "O"-RING TO 37° (6 F50X-S)	2
6	07-004085		CAP SCREW, HEX HEAD (1/2"-13 x 1", Grade 8)	6
7	07-061018		WASHER, FLAT (1/2", SAE, hardened)	6
8	07-111300		CAP SCREW, HEX HEAD (1"-8 x 11", Grade 8)	1
9	07-060024		WASHER, FLAT (1", SAE)	2
10	07-090011		NUT, LOCK (1"-8, Grade 8)	1
11	01-202000		VALVE, CROSSOVER RELIEF (1200 psi)	1
12	06-039500		ADAPTER, "O"-RING TO 37° (4-6 F50X-S)	2
13	06-039800		ADAPTER, "O"-RING TO 37° (6 F50X-S)	2
14	350 7654		TUBE ASSEMBLY, FLOW DIVIDER (3/8")	2
15	07-003053		CAP SCREW, HEX HEAD (3/8"-16 x 3", Grade 5)	2
16	07-065016		WASHER, HELICAL LOCK (3/8")	2
17	See Plate . .		C08. - -	PLATFORM CONTROL CONSOLE ASSEMBLY
18	235 7060	SUPPORT, PLATFORM CONTROL BOX (some earlier versions)		2
19	07-008039		CAP SCREW, SOCKET HEAD (5/16"-18 x 3", Grade 8)	4
20	07-062015		WASHER, FLAT (5/16")	4
21	07-050015		NUT, LOCK (5/16"-18, Grade 5)	4
22	03-021300		SWITCH ASSEMBLY, FOOT (Single pole)	1
23	03-021301		SWITCH (Single pole, double throw)	1
24	03-021302		COVER, SWITCH (Guard type, with latch)	1
25	03-045000		REDUCER (3/4" to 1/2")	1
26	03-063300		GRIP, CORD (90°, 1/2", with .31" to .38" seal)	1
27	03-085700		CABLE, ELECTRICAL (SJO, 4 conductor, #16 AWG) (Bulk item, 6 ft [1.8 m] required this application)	A.R.
28	07-003001		CAP SCREW, HEX HEAD (1/4"-20 x 1/2", Grade 5)	2
29	07-062014		WASHER, FLAT (1/4")	4
30	07-050014		NUT, LOCK (1/4"-20, Grade 5)	2
31			RECEPTACLE, ELECTRICAL CONVENIENCE <b>Standard</b> , Duplex, 20 Amp, 110 Volt AC, Self-grounding	1
32	03-067000		<b>Optional</b> , Single, 20 Amp, 220 Volt AC	1
	03-711300 03-062100		BOX, ELECTRICAL RECEPTACLE (Weatherproof)	

TITLE

PLATFORM ASSEMBLY, RP 86

SECTION **B04.** | PLATE NO. **203** | PAGE **01** | REV. **A** | DATED 24 JUN., 1996 | PART NO.



Simon Aerials Inc.  
10600 West Brown Deer Road  
Milwaukee Wisconsin 53224 USA  
Parts Phone 1-800-47-SIMON  
24 Hr (Machine) 414-362-8280  
Fax 414-355-3172

## PARTS LIST

ITEM	PART NO	SEE SECTION	DESCRIPTION	QTY.
1	354 2880		SPINDLE ASSEMBLY (RP 86 and T-80, Right hand)	1
	354 2890		SPINDLE ASSEMBLY (RP 86 and T-80, Left hand)	1
2	235 2590		SPINDLE (Right)	1
	235 2580		SPINDLE (Left)	1
3	219 7900		HUB, SPINDLE	1
4	08-003400		CUP, BEARING (Outer) (4.437" [113 mm] O.D.)	1
5	08-070500		CUP, BEARING (Inner) (5.000" [127 mm] O.D.)	1
6	08-003500		CONE AND ROLLER, BEARING (Outer) (2.750" [70 mm] I.D.)	1
7	08-070600		CONE AND ROLLER, BEARING (Inner) (3.000" [76 mm] I.D.)	1
8	01-217500		SEAL, SHAFT OIL (3-3/4" [95 mm] I.D., 5" O.D.)	1
9	07-030651		STUD, WHEEL MOUNTING (3/4"-16 x 2-1/2", Grade 5)	10
10	07-062027		WASHER, FLAT (1-3/4")	1
11	07-045227		NUT, HEX (Slotted) (1-3/4"-12, Grade 5)	1
12	07-070511		PIN, COTTER (1/8" x 2-1/2" long)	1
13	202 1131		PLATE, SPINDLE END COVER	1
14	07-003001		CAP SCREW, HEX HEAD (1/4"-20 x 1/2", Grade 5)	3
15	07-065014		WASHER, HELICAL LOCK (1/4")	3
16	08-014000		BEARING, SLEEVE (1-1/2" [38 mm] I.D., 1-3/4" [44.5 mm] O.D., 1-1/2" [38 mm] long)	2
17	10-164100		SEAL, SPINDLE PIN OIL (Not shown. With option. Spindle must be counterbored.) (1-1/2" [38 mm] I.D., 2" [51 mm] O.D.)	2
18	08-051300		FITTING, GREASE (1/8", 90°)	1
19	08-066300		CAP, GREASE FITTING (White plastic)	1

TITLE **FRONT STEER SPINDLE ASSEMBLY (TWO WHEEL DRIVE)**

SECTION **C01.** | PLATE NO. **201** | PAGE **01** | REV. **A** | DATED **12 JUN., 1996** | PART NO.

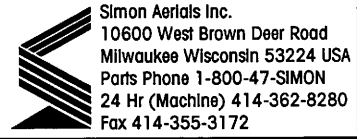

## PARTS LIST

ITEM	PART NO	SEE SECTION	DESCRIPTION	QTY.
			The following items will be found in a <u>typical</u> application. They are <b>not</b> included with the Ground Valve Bank, but they are included with the Ground Valve Bank Assembly:	
22	06-040900		<b>Valve Segment 8 (at top) (Drive Reverse, Forward):</b> ADAPTER, "O"-RING TO 37° (12-8 F50X-S)	2
23	06-053300		45° ELBOW, SWIVEL NUT (12 V6X-S)	2
			<b>Valve Segment 7 (Manifold Pressure to Platform):</b>	
24	06-090600		REDUCER/ EXPANDER (8-6 F50 G5-S)	1
25	06-048500		RUN TEE, MALE "O"-RING TO 37° (6 R50X-S)	1
			<b>Valve Segment 6 (Swing Right, Left):</b>	
26	06-090500		REDUCER/ EXPANDER (8-4 F50 G5-S)	2
27	06-046800		45° ELBOW, "O"-RING TO 37° (4 V50X-S)	2
			<b>Valve Segment 5 (Boom Down):</b>	
28	06-047100		45° ELBOW, "O"-RING TO 37° (8 V50X-S)	1
			<b>Valve Segment 5 (Boom Up):</b>	
29	06-047100		45° ELBOW, "O"-RING TO 37° (8 V50X-S)	2
30	06-207800		ADAPTER, SWIVEL NUT (8 F650X-S)	1
31	01-019000		VALVE, FLOW CONTROL (Needle valve, #8 SAE ports)	1
			<b>Valve Segment 4 (Boom Extend, Retract):</b>	
32	06-047100		45° ELBOW, "O"-RING TO 37° (8 V50X-S)	2
			<b>Valve Segment 3 (Jib Boom Retract, Extend):</b>	
33	06-090500		REDUCER/ EXPANDER (8-4 F50 G5-S)	2
34	06-046800		45° ELBOW, "O"-RING TO 37° (4 V50X-S)	2
			<b>Valve Segment 2 (Steer Right, Left):</b>	
35	06-090600		REDUCER/ EXPANDER (8-6 F50 G5-S)	2
36	06-047000		45° ELBOW, "O"-RING TO 37° (6 V50X-S)	2
			<b>Valve Segment 1 (at bottom) (Drive Reverse, Forward):</b>	
37	06-040900		ADAPTER, "O"-RING TO 37° (12-8 F50X-S)	2
38	06-053300		45° ELBOW, SWIVEL NUT (12 V6X-S)	2

TITLE

**HYDRAULIC VALVE MANIFOLD ASSEMBLY, RP 86**

SECTION **C02.** PLATE NO. **206** PAGE **02** REV. **A** DATED **24 JUN., 1996** PART NO.



CLICK HERE TO **DOWNLOAD** THE COMPLETE MANUAL

- Thank you very much for reading the preview of the manual.
- You can download the complete manual from: [www.heydownloads.com](http://www.heydownloads.com) by clicking the link below



- Please note: If there is no response to CLICKING the link, please download this PDF first and then click on it.

CLICK HERE TO **DOWNLOAD** THE COMPLETE MANUAL

## PARTS LIST

ITEM	PART NO	SEE SECTION	DESCRIPTION	QTY.
40	07-003002		ENGINE ASSEMBLY (continued) CAP SCREW, HEX HEAD (1/4"-20 x 5/8", Gr. 5) (Panel ground, used on some earlier versions. Not shown.)	1
41	07-060014		WASHER, FLAT (1/4", SAE)	1
42	07-111600		WASHER, EXTERNAL TOOTH LOCK (1/4")	1
43	07-050014		NUT, LOCK (1/4"-20, Grade 5)	1
44	03-473700		HOUSING, TERMINAL (4 conductor)	2
45	03-473800		PLUG, TERMINAL (4 conductor)	2
46	03-474000		SOCKET, TERMINAL (for 14-16 gauge wire)	6
47	03-473900		PIN, TERMINAL	6
48	03-474100		SEAL, WIRE (.079" to .110" dia.)	6
49	01-239800	D08.15	PUMP ASSEMBLY, HYDRAULIC (marked "PAVC 65 X 3266") (65 c.c./ rev. output, 3500 psi)	1
50	07-003126		CAP SCREW, HEX HEAD (5/8"-11 x 1-1/4", Grade 5)	4
51	07-060021		WASHER, FLAT (5/8")	4
52	07-065021		WASHER, HELICAL LOCK (5/8")	4
53	06-214400		FLANGE, SUCTION FITTING (2") (includes two flange halves and mounting hardware)	1
54	06-214300		90° FITTING (2" stem to 1-1/2" hose)	1
55	06-190600		45° ELBOW ("O"-Ring to beaded hose connection) (earlier)	1
	06-218000		45° ELBOW ("O"-Ring to threaded hose connection) (later)	1
56	06-047000		45° ELBOW, ""O"-RING TO 37° (6 V50X-S)	1
57	353 6550		TUBE, HYDRAULIC	1
58	06-048500		RUN TEE, MALE ""O"-RING TO 37° (6 R50X-S)	1
59	01-013900		VALVE BLOCK, CARTRIDGE	1
60	01-013700		VALVE, TWO-WAY (Solenoid operated)	1
61	01-013701		SEAL KIT, VALVE	1
62	01-013702		COIL (12 Volt DC)	1
63	06-079000		CONNECTOR, SWIVEL NUT (6 F650X-S)	1
64	06-054500		RUN TEE, 37° FEMALE SWIVEL NUT (6 R6X-S)	1
65	06-191900		ADAPTER, ""O"-RING TO 37° (6-4 F50X-S)	1
66	02-011500		ADAPTER, PUMP (1/2" [13 mm] thick) (8 hole, 12-3/8" pilot flywheel housing to "C" [2 hole, 5" pilot] pump mount)	1
67	07-005184		CAP SCREW, HEX HEAD (M10 x 25 mm, Grade 8.8)	8
68	07-066006		WASHER, LOCK (10 mm)	8
69	03-074000		CABLE, GROUND (Black, 9-3/4" [25 cm] long) or . . .	1
	03-735800		STRAP, GROUND (Braided, 12" [30.5 cm] long)	1
70	07-062018		WASHER, FLAT (1/2")	1
71	07-062016		WASHER, FLAT (3/8")	1
72	07-065016		WASHER, HELICAL LOCK (3/8")	1
73	07-040016		NUT, HEX (3/8"-16, Grade 5)	1

TITLE

**ENGINE ASSEMBLY, DEUTZ F4L 1011 DIESEL**

SECTION **C04.** | PLATE NO. **201** | PAGE **02** | REV. - | DATED 10 MAY, 1996 | PART NO.



Simon Aerials Inc.  
10600 West Brown Deer Road  
Milwaukee Wisconsin 53224 USA  
Parts Phone 1-800-47-SIMON  
24 Hr (Machine) 414-362-8280  
Fax 414-355-3172

## PARTS LIST

ITEM	PART NO	SEE SECTION	DESCRIPTION	QTY.
1	Call Simon Call Simon		ENGINE ASSEMBLY (Ford LRG-423) 63 HP (47 Kw) liquid cooled <b>gas</b> four cylinder 63 HP (47 Kw) liquid cooled <b>dual fuel</b> four cylinder	1
2	-----		RELAY, STARTER (Comes with engine. Marked "E4JL-11450-AA")	1
3	-----		MODULE (Blue. Comes with engine. Marked "F4JL-12A458-BB")	1
4	-----		MODULE (Gray. Comes with engine. Marked "F5JL-12A297-BA")	1
5	-----		BRACKET, FUEL PUMP MOUNTING (c/w engine)	1
6			BRACKET, RADIATOR MOUNTING	1
7			BRACKET, THROTTLE CABLE	1
8			ARM, THROTTLE LEVER	1
9			BRACKET, THROTTLE SOLENOID	1
10	07-060015		WASHER, FLAT (5/16", SAE)	8
11	07-050015		NUT, STOP (5/16"-18)	4
12	03-736200		SOLENOID (includes cable end hardware)	2
13	07-003005		CAP SCREW, HEX HEAD (1/4"-20 x 1", Grade 5)	4
14	07-060014		WASHER, FLAT (1/4", SAE)	8
15	07-050014		NUT, LOCK (1/4"-20, Grade 5)	4
16	235 2040		PANEL, ENGINE ACCESSORY	1
17	06-059000		SPACER (Sleeve 6 TX-S)	4
18	07-060016		WASHER, FLAT (3/8", SAE)	8
19	07-050016		NUT, STOP (3/8"-16)	4
20			RELAY	1
21	07-003002		CAP SCREW, HEX HEAD (1/4"-20 x 5/8", Grade 5)	1
22	07-060014		WASHER, FLAT (1/4", SAE)	1
23	07-111600		WASHER, EXTERNAL TOOTH LOCK (1/4")	1
24	07-050014		NUT, LOCK (1/4"-20, Grade 5)	1
25	03-468700		BLOCK, TERMINAL (14 station)	1
26	07-011334		MACHINE SCREW, ROUND HEAD (#6 32 x 3/4")	2
27	07-050007		NUT, STOP (#6-32, Grade 5)	2
28	03-473700		HOUSING, TERMINAL (4 conductor)	2
29	03-473800		PLUG, TERMINAL (4 conductor)	2
30	03-474000		SOCKET, TERMINAL (for 14-16 gauge wire)	6
31	03-473900		PIN, TERMINAL	6
32	03-474100		SEAL, WIRE (.079" to .110" dia.)	6
33	01-239800	D08.15	PUMP ASSEMBLY, HYDRAULIC (marked "PAVC 65 X <b>3266</b> ") (65 c.c./ rev. output, 3500 psi)	1
34	07-003126		CAP SCREW, HEX HEAD (5/8"-11 x 1-1/4", Grade 5)	4
35	07-060021		WASHER, FLAT (5/8")	4
36	07-065021		WASHER, HELICAL LOCK (5/8")	4

TITLE

**ENGINE ASSEMBLY, FORD LRG-423**

SECTION **C04.** | PLATE NO. **203** | PAGE **01**

REV. - | DATED 24 JUN., 1996 | PART NO.



Simon Aerials Inc.  
10600 West Brown Deer Road  
Milwaukee Wisconsin 53224 USA  
Parts Phone 1-800-47-SIMON  
24 Hr (Machine) 414-362-8280  
Fax 414-355-3172

## PARTS LIST

ITEM	PART NO	SEE SECTION	DESCRIPTION	QTY.
1	354 2811		HYDRAULIC TANK ASSEMBLY (Current version. Earlier version was identified as 354 2810)	1
2	234 9000		TANK WELDMENT, HYDRAULIC	1
3	10-097800		CAP ASSEMBLY, HYDRAULIC TANK FILLER (includes 10 micron filter, breather and strainer)	1
4	10-032500		GAUGE, SIGHT (7" [17.8 cm] long)	1
5	06-217300		ADAPTER, "O"-RING TO FEMALE NPT (20-1-1/4 F50 G-S)	2
6	11-050021		90° STREET ELBOW (1-1/4")	1
7	11-303100		NIPPLE, PIPE (1-1/4" NPT, 4" long)	1
8	01-238000		FILTER, HYDRAULIC (Return line)	1
9	01-238001		CANISTER, FILTER (with 10 micron element)	1
10	06-092300		REDUCER/ EXPANDER (20-16 F50 G5-S)	1
11	01-040400		"O"-RING	1
12	01-015900		VALVE, CHECK (#16 SAE ports)	1
13	06-052000		90° ELBOW, SWIVEL NUT (16 C6X-S)	1
14	06-058000		NUT, TUBE (16 BTX-S)	1
15	06-061100		REDUCER, TUBE END (16-12 TRTX-S)	1
16	06-054800		RUN TEE, 37° FEMALE SWIVEL NUT (12 R6X-S)	1
17	06-051800		90° ELBOW, SWIVEL NUT (12 C6X-S)	1
18	11-020018		CLOSE NIPPLE (3/4" NPT x 1-3/8" long)	1
19	01-020600		VALVE, BALL (Shutoff valve) (3/4" NPT)	1
20	06-209400		90° ELBOW, MALE 37° TO NPT (8-12 CTX-S)	1
21	11-071500		CLOSE NIPPLE (1-1/2" NPT x 1-3/4" long)	2
22	01-063000		VALVE, BALL (Shutoff valve) (1-1/2" NPT)	2
23	06-218400		FITTING, STRAIGHT (24MP-24MJ)	2
24	11-075500		PLUG, SQUARE HEAD (3/4" NPT)	1
25	06-095000		PLUG, HEX SOCKET "O"-RING (6 HP50N-S)	1
26	06-096100		UNION (6 F50 F50-S)	1
27	01-018900		VALVE, FLOW CONTROL (#6 SAE ports) (Earlier versions used Poppet Check Valve 01-020800)	1
28	06-044600		90° ELBOW, "O"-RING TO 37° (6 C50X-S) (Earlier versions used fitting 06-044400 [4-6 C50X])	1
29	11-075100		PLUG, SQUARE HEAD (1-1/2" NPT)	1
30	01-015800		DRAIN COCK (Brass, 1/2" NPT)	1
31	10-151300		PLACARD, "HYDRAULIC FLUID ONLY" (supplied with tank ass'y.)	2
	10-151302		PLACARD, "LIQUIDE HYDRAULIQUE SEULEMENT" ( <b>French</b> )	
	10-151303		PLACARD, "NUR HYDRAULIKÖL" ( <b>German language</b> )	
The following item is <b>not</b> included with the Hydraulic Tank Assembly:				
32	06-045800		90° ELBOW, "O"-RING TO 37° (16 C50X) (for earlier versions)	1
33	10-267703		DECAL, "MAX./ MIN. HYD. ÖLSTAND" (Two part, Hydraulic fluid level, in German language)	1

TITLE **HYDRAULIC TANK ASSEMBLY, RP 86 AND T-80**

SECTION **C10.** | PLATE NO. **06** | PAGE **01** | REV. **A** | DATED **13 JUN., 1996** | PART NO.



Simon Aerials Inc.  
10600 West Brown Deer Road  
Milwaukee Wisconsin 53224 USA  
Parts Phone 1-800-47-SIMON  
24 Hr (Machine) 414-362-8280  
Fax 414-355-3172



## PARTS LIST

ITEM	PART NO	SEE SECTION	DESCRIPTION	QTY.
27	235 1400		FRONT (STEER) AXLE ASSEMBLY (Continued) AXLE, INNER (End section) (Right) Earlier version (used with center section 235 2390)	1
28	235 6420 235 1550		Later version (used with center section 235 6280) AXLE, INNER (End section) (Left) Earlier version (used with center section 235 2390)	1
29	235 6350 235 1560		Later version (used with center section 235 6280) PAD, UPPER GUIDE (5.5" x 6.25" [140 x 159 mm])	2
30	07-003086		CAP SCREW, HEX HEAD (1/2"-13 x 1-1/4", Grade 5)	4
31	07-065018		WASHER, HELICAL LOCK (1/2")	4
32	07-047018		NUT, HEX JAM (1/2"-13, Grade 5)	4
33			PAD, INNER REST (at bottom)	2
34	235 2080 235 6380		Earlier version (for end section 235 1400 or 235 1550) Later version (for end section 235 6420 or 235 6350) SHIM, INNER REST PAD (4" x 6" [102 x 153 mm])	A.R.
35	235 2880 235 2890 07-003087		12 Ga (.1046" [2.6 mm] thick) 16 Ga (.0598" [1.5 mm] thick) CAP SCREW, HEX HEAD (1/2"-13 x 1-1/2", Grade 5)	4
36	07-065018		WASHER, HELICAL LOCK (1/2")	4
37	235 3850		PAD, INNER SIDE (2" x 7" [51 x 178 mm]) Earlier version (Nylon)	4
38	235 6460 235 3860		Later version (Steel) SHIM (for later, steel pad) (2" x 7" [51 x 178 mm]) 12 Ga (.1046" [2.6 mm] thick)	A.R.
39	235 3870 07-003085		16 Ga (.0598" [1.5 mm] thick) CAP SCREW, HEX HEAD (1/2"-13 x 1", Grade 5)	8
40	07-065018		WASHER, HELICAL LOCK (1/2")	8
41	07-047018		NUT, HEX JAM (1/2"-13, Grade 5) (for earlier, nylon pad)	8

TITLE					<b>FRONT (STEER) AXLE ASSEMBLY (TWO WHEEL DRIVE)</b>						
SECTION	<b>C13.</b>	PLATE NO.	<b>201</b>	PAGE	<b>02</b>	REV.	<b>A</b>	DATED	<b>21 JUN., 1996</b>	PART NO.	<b>354 5750</b>



## PARTS LIST

ITEM	PART NO	SEE SECTION	DESCRIPTION	QTY.
1	354 2910		REAR (DRIVE) AXLE ASSEMBLY Standard version (Without Four Wheel Steering)	1
2	235 0290		AXLE, OUTER (Center section) (Note: On some earlier versions, the axle inner stop bolts to the axle; five bolts are visible down the rear face centerline. Items 3 through 5 are for these earlier machines. On later versions, the stop is welded in place.)	1
3	235 1220		STOP, AXLE INNER (For earlier versions. Later is welded on.)	1
4	07-003045		CAP SCREW, HEX HEAD (3/8"-16 x 1", Grade 5)	5
5	07-065016		WASHER, HELICAL LOCK (3/8")	5
6	235 0820		STOP, AXLE OUTER (at bottom)	2
7	07-003086		CAP SCREW, HEX HEAD (1/2"-13 x 1-1/4", Grade 5)	8
8	218 7740		PAD, DRIVE AXLE	4
9	07-003085		CAP SCREW, HEX HEAD (1/2"-13 x 1", Grade 5)	8
10	07-065018		WASHER, HELICAL LOCK (1/2")	16
11	07-047018		NUT, HEX JAM (1/2"-13, Grade 5)	8
12	235 0830		PAD, OUTER REST (at top) (5.5" x 11.75" [140 x 298 mm])	2
13			SHIM, OUTER REST PAD (5.5" x 11.75" [140 x 298 mm])	A.R.
	235 2310		12 Ga (.1046" [2.6 mm] thick)	
	235 2300		16 Ga (.0598" [1.5 mm] thick)	
14	07-003086		CAP SCREW, HEX HEAD (1/2"-13 x 1-1/4", Grade 5)	4
15	07-065018		WASHER, HELICAL LOCK (1/2")	4
16	235 3710		PAD, OUTER SIDE (2" x 4" [51 x 102 mm])	8
17			SHIM (2" x 4" [51 x 102 mm])	A.R.
	235 2280		12 Ga (.1046" [2.6 mm] thick)	
	235 2290		16 Ga (.0598" [1.5 mm] thick)	
18	07-003095		CAP SCREW, HEX HEAD (1/2"-13 x 3-1/2", Grade 5) (upper)	8
19	07-003085		CAP SCREW, HEX HEAD (1/2"-13 x 1", Grade 5) (lower)	8
20	07-065018		WASHER, HELICAL LOCK (1/2")	16
21	03-735600		SWITCH, LIMIT (Positive break, side rotary)	2
22	03-735700		ARM, LIMIT SWITCH (Fixed roller, 1.75" [44 mm] dia.)	2
23	03-085200		WIRE, ELECTRICAL (SJO, 2 conductor, #16 Ga.) (Limit switch)	A.R.
24	03-041000		GRIP, CORD (Plastic, 1/2", with .38" to .44" seal)	2
25	07-008355		CAP SCREW, SOCKET HEAD (#10-24x 1-1/2", Grade 8)	8
26	235 2780		CLAMP, HOSE (Nylon, three pieces)	2
27	235 2770		BRACKET, HOSE CLAMP	4
28	07-003055		CAP SCREW, HEX HEAD (3/8"-16 x 3-1/2", Grade 5)	4
29	07-040016		NUT, HEX (3/8"-16, Grade 5)	6
30	07-003060		CAP SCREW, HEX HEAD (3/8"-16 x 6", Grade 5)	2
31	235 5630		SPACER, HOSE CLAMP MOUNTING (1.25" [32 mm] lomg)	2
32	235 5640		SPACER, HOSE CLAMP MOUNTING (.50" [13 mm] lomg)	2

TITLE <b>REAR (DRIVE) AXLE ASSEMBLY, RP 86 AND T-80</b>				
SECTION <b>C13.</b>	PLATE NO. <b>203</b>	PAGE <b>01</b>	REV. <b>A</b>	DATED 21 JUN., 1996
			PART NO. <b>354 2910</b>	



Simon Aerials Inc.  
10600 West Brown Deer Road  
Milwaukee Wisconsin 53224 USA  
Parts Phone 1-800-47-SIMON  
24 Hr (Machine) 414-362-8280  
Fax 414-355-3172

## PARTS LIST

ITEM	PART NO	SEE SECTION	DESCRIPTION	QTY.
1	04-008700 235 1600		HYDRAULIC SWIVEL For all versions except as listed below For Model RP 86 or T-80	1
2			HOUSING, HYDRAULIC SWIVEL	1
3			SPOOL	1
4			RETAINER PLATE	1
5	04-008703 236 0930		ARM, TORQUE Standard 8" (203 mm) long arm for Swivel 04-008700 4" (102 mm) long arm for Hydraulic Swivel 235 1600	2
6	04-008702		SERVICE KIT, HYDRAULIC SWIVEL <b>Note:</b> Items in service kit identified by asterisk (*).	1
7*			"O"-RING	2
8*			RING, WEAR	1
9*			RING, WEAR	1
10*	04-008701		SEAL KIT (consists of [7] "O"-Rings and [7] Slipper seals)	1
11	04-008704		CAP SCREW, SOCKET HEAD	4
12			CAP SCREW, SOCKET HEAD	4
13			WASHER, LOCK	4
			The following item is <b>not</b> included with Hydraulic Swivel 04-008700, but replaces Item #5 in some applications:	
14	210 1030		STOP, SWIVEL	2
			The following items <b>are not</b> included with Hydraulic Swivel 04-008700 or 235 1600:	
15	06-192200		HOSE FITTING (S2102-8-8) (For center port on <b>some versions</b> of Model MP 80 and smaller)	1
16	06-071400		REDUCER, PIPE THREAD (3/4 x 1/2 PTR-S) (For center port on Model MPH 80, MP 95, MP 110 and RP 120)	1

TITLE

HYDRAULIC SWIVEL

SECTION **D02.** PLATE NO. **01** | PAGE **01** | REV. - | DATED 22 APR., 1996 | PART NO.



Simon Aerials Inc.  
10600 West Brown Deer Road  
Milwaukee Wisconsin 53224 USA  
Parts Phone 1-800-47-SIMON  
24 Hr (Machine) 414-362-8280  
Fax 414-355-3172

## PARTS LIST

ITEM	PART NO	SEE SECTION	DESCRIPTION	QTY.
1	354 2790		CYLINDER ASSEMBLY, DOUBLE TELESCOPE	1
2	04-055000		CYLINDER, DOUBLE TELESCOPE	1
3	354 0160		TUBE, EXTEND (bent section)	1
4	354 4750		TUBE, EXTEND (straight section, 81.12" [2.06 m] long)	1
5	06-217600		UNION, "O"-RING (#8-#8. F027-2403-0)	2
6	06-213700		ADAPTER, "O"-RING (#8-#8)	4
7	354 0160		TUBE, RETRACT (bent section)	1
8	354 4650		TUBE, RETRACT (straight section, 79.62" [2.02 m] long)	1
9	10-267500		PAD, RUBBER (2.5" x 12" x 1/8" thick)	10
10	09-008700		CLAMP, HOSE (4.5" [114 mm])	2
11	09-020000		CLAMP, HOSE (5.0" [127 mm])	3
12	232 1420		PAD, SLIDER	2
13	07-016045		CAP SCREW, FLAT SOCKET HEAD (3/8"-16 x 1", Grade 5)	4
14	01-239000		VALVE KIT, TELESCOPE CYLINDER	1
15			BLOCK, VALVE	1
16			VALVE, COUNTERBALANCE (Extend) (set at 4000 psi [276 bar] [281 kg/ cm <sup>2</sup> ]) (Valve is marked "9BH5-CBEA-LHN")	1
17			VALVE, COUNTERBALANCE (Retract) (Valve is marked "9L04-CACA-LHM")	1
18	06-044800		90° ELBOW, "O"-RING TO 37° (8 C50X-S)	1
19	06-044600		90° ELBOW, "O"-RING TO 37° (6 C50X-S)	1
20	06-094800		PLUG, HEX SOCKET "O"-RING (4 HP50-S)	2
			The following item is <b>not</b> included with the Telescope Cylinder:	
21	235 9800		SPACER, ROD (External) (Was used on some early versions)	1

TITLE					<b>TELESCOPE CYLINDER ASSEMBLY</b>						
SECTION	<b>D19.</b>	PLATE NO.	<b>202</b>	PAGE	<b>01</b>	REV.	<b>A</b>	DATED	<b>21 JUN., 1996</b>	PART NO.	<b>354 2790</b>



## PARTS LIST

ITEM	PART NO	SEE SECTION	DESCRIPTION	QTY.
1	354 6550		TOW PACKAGE ASSEMBLY	1
2	235 9610		UNDERCARRIAGE WELDMENT MODIFICATIONS	1
3	234 4150		PIVOT, TOW	1
4	201 4368		BRACKET, TOW BAR (Pin end)	2
5	234 4150		BRACKET, TOW BAR (Socket end)	1
6	235 9620		BRACKET, TIE ROD STORAGE	2
7	235 9490		STEER ARM, CENTER (includes bushings)	1
8	08-002000		BEARING, FLANGED (1-1/2" I.D., 1-3/4" O.D., 2" flange)	2
9	232 7430		PIN, CENTER STEER ARM (1.5" x 9.62")	1
10	08-040900		RING, SNAP (1.5")	2
11	07-003094		CAP SCREW, HEX HEAD (1/2"-13 x 3-1/4", Grade 5)	1
12	07-058400		NUT, LOCK (1/2"-13, Grade 8)	1
13	08-051300		FITTING, GREASE (90°, 1/8" NPT)	1
14	08-066300		CAP, GREASE FITTING (White plastic)	1
15			SPINDLE WELDMENT (Front Axle, Left)	1
16	235 9480		for Four Wheel Drive versions	
17	354 6540		TIE ROD ASSEMBLY	1
18	235 9600		ROD, TIE	1
19	08-016800		TIE ROD END (Right hand thread)	1
20	07-090004		NUT, JAM (1-1/4", Right hand thread)	1
21	08-016900		TIE ROD END (Left hand thread)	1
22	07-090005		NUT, JAM (1-1/4", Left hand thread)	1
23	08-050000		FITTING, GREASE (Straight, 1/8" NPT)	2
24	08-066300		CAP, GREASE FITTING (White plastic)	2
25	235 9990		PIN, CLEVIS (1" x 3-1/2")	2
26	04-003404		CLIP, HAIRPIN	2
27	209 8450		TOW BAR	1
28	210 8970		PIN, HITCH	1
29	01-010900		VALVE, SELECTOR	1
30	06-004000		90° ELBOW, MALE 37° TO NPT (6-6 CTX-S)	3
31	07-040015		NUT, HEX (5/16"-18, Grade 5)	2
32	07-065015		WASHER, HELICAL LOCK (5/16")	2
33	11-007004		ROD, THREADED (3/8"-16, Grade 2. 3 ft [.91 m] long piece. 12" [.31 m] needed here)	A.R.
34	07-040016		NUT, HEX (3/8"-16, Grade 5)	1
35	07-065016		WASHER, HELICAL LOCK (3/8")	1
36	10-042400		KNOB, BALL (Black Plastic, 3/8"-16 thread)	1
37	06-054500		RUN TEE, 37° FEMALE SWIVEL NUT (6 R6X-S) (Not shown. Mounts to Hydraulic Swivel, bottom section, Ports 3, 4, and 5)	3

TITLE **TOW PACKAGE, RP 86 AND T-80**

SECTION **F05.** | PLATE NO. **03** | PAGE **01** | REV. **A** | DATED **21 JUN., 1996** | PART NO. **354 6550**



Simon Aerials Inc.  
10600 West Brown Deer Road  
Milwaukee Wisconsin 53224 USA  
Parts Phone 1-800-47-SIMON  
24 Hr (Machine) 414-362-8280  
Fax 414-355-3172

CLICK HERE TO **DOWNLOAD** THE COMPLETE MANUAL

- Thank you very much for reading the preview of the manual.
- You can download the complete manual from: [www.heydownloads.com](http://www.heydownloads.com) by clicking the link below



- Please note: If there is no response to CLICKING the link, please download this PDF first and then click on it.

CLICK HERE TO **DOWNLOAD** THE COMPLETE MANUAL