

# PARTS MANUAL

**TL240**

Serial No. 224000001~

BU2Z002-1(P-TL240BAB)

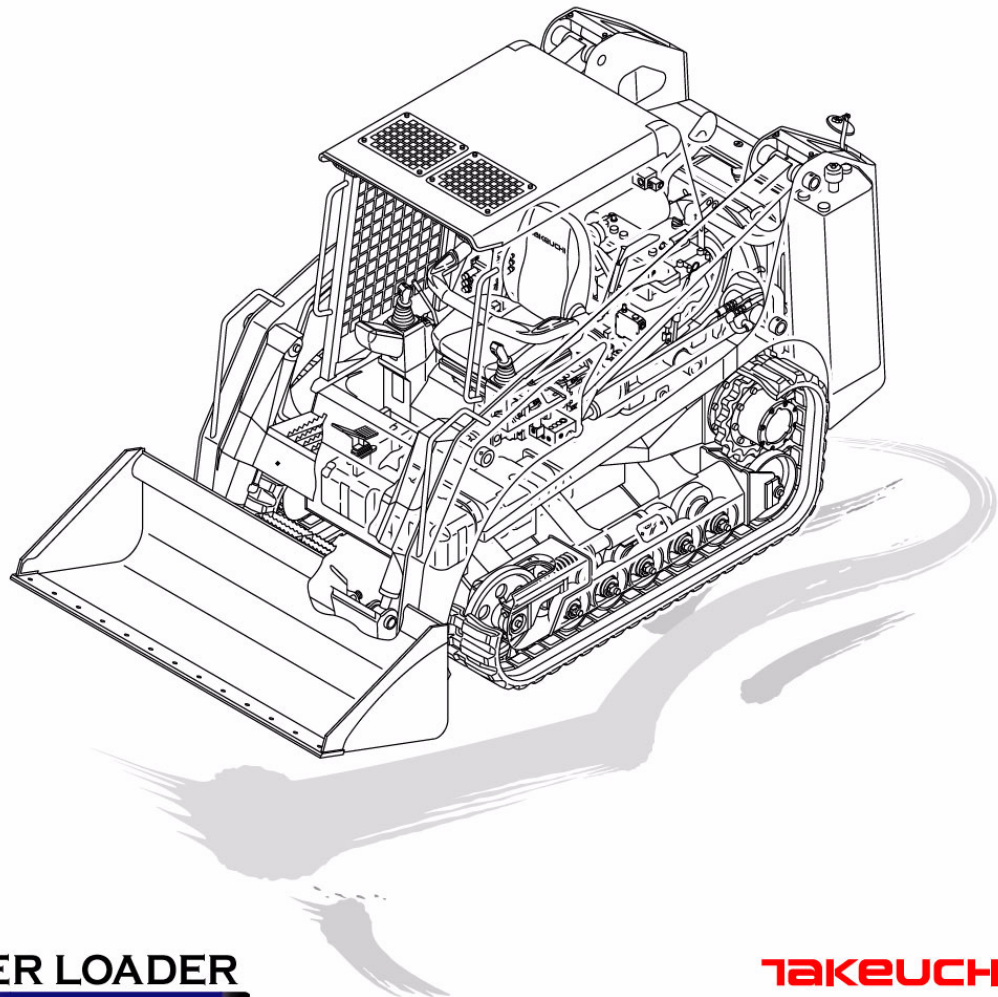

**CRAWLER LOADER**

**TAKEUCHI**

CLICK HERE TO **DOWNLOAD** THE COMPLETE MANUAL

- Thank you very much for reading the preview of the manual.
- You can download the complete manual from: [www.heydownloads.com](http://www.heydownloads.com) by clicking the link below



- Please note: If there is no response to CLICKING the link, please download this PDF first and then click on it.

CLICK HERE TO **DOWNLOAD** THE COMPLETE MANUAL

**TRACK ADJUSTER**

Item	Part number	Description	Q'ty	Chan.	Serial No.	Serv.	Remarks
0	<b>0882150000</b>	SPRING ASSY (L.H.)	1				
	<b>0882150100</b>	SPRING ASSY (R.H.)	1				
1	<b>0882150210</b>	· YOKE	1				
2	<b>0881151200</b>	· ROD	1				
3	<b>0007000002</b>	· SPRING	1				
4	<b>1132530027</b>	· NUT	1				
5	<b>1210000545</b>	· PIN, split	1				
0-1	<b>0881152400</b>	· CYLINDER ASSY (L.H.)	1				
	<b>0881152600</b>	· CYLINDER ASSY (R.H.)	1				
7	<b>0881152100</b>	· · CYLINDER, grease (L.H.)	1				
8	<b>0881152200</b>	· · PISTON	1				
9	<b>1541300501</b>	· · VALVE ASSY, check	1				
10	<b>1400403203</b>	· · SEAL, oil	1				
11	<b>1422010600</b>	· · O-RING	1				
12	<b>1421020600</b>	· · RING, back-up	1				
13	<b>0881152300</b>	· · CYLINDER, grease (R.H.)	1				
	<b>U2a060</b>						

**HOOK**

Item	Part number	Description	Q'ty	Chan.	Serial No.	Serv.	Remarks
		HOOK ASSY					
1	<b>0881304520</b>	HOOK	2				
2	<b>1110042040</b>	SCREW, cap	4				
3	<b>1110042070</b>	SCREW, cap	2				
4	<b>0881602950</b>	SHIM	AR				t=0.5mm
7	<b>0399300500</b>	DECAL	2				
	<b>T9b051</b>						

**ENGINE & ACCESSORIES (2/4)**

Item	Part number	Description	Q'ty	Chan.	Serial No.	Serv.	Remarks
		ENGINE ASSY (for US)					
		ENGINE ASSY (for EU)					
		ENGINE ASSY (for US, with air conditioner)					
		ENGINE ASSY (for EU, with air conditioner)					
6	<b>0684001200</b>	SHROUD ASSY	1				
6-1	<b>0684001210</b>	· SHROUD	1				
6-2	<b>1654606260</b>	· TRIM	1				sold by the meter
6-3	<b>0872433150</b>	· TUBE	6				
7	<b>0664001070</b>	GUARD	1				
8	<b>0684001100</b>	RADIATOR ASSY	1				see page (3/4)
15	<b>0684001250</b>	BRACKET	2				
16	<b>1910146020</b>	TANK, sub	1				Y129466-44510
17	<b>0684001260</b>	HOSE	1		224000001~224000020		
	<b>0684001230</b>	HOSE	1		224000021~	M	
19	<b>0684001270</b>	HOSE	1		224000001~224000020		
20	<b>0684000550</b>	HOSE	1				
25	<b>0880406610</b>	SHIM	AR				t=1.6mm
26	<b>0880406620</b>	SHIM	AR				t=3.2mm
27	<b>0880406630</b>	SHIM	AR				t=4.5mm
35	<b>1140020012</b>	WASHER, spring	2				
36	<b>1100040816</b>	BOLT	5				
38	<b>1100041025</b>	BOLT	8				
40	<b>1100041230</b>	BOLT	2				
45	<b>1141110008</b>	WASHER	4				
46	<b>1141110010</b>	WASHER	12				
49	<b>0003600136</b>	SHIM	2				
50	<b>1910078037</b>	COCK	1				Y129150-49100
53	<b>1140020008</b>	WASHER, spring	5				
54	<b>1140020010</b>	WASHER, spring	12				
59	<b>0880406110</b>	PLATE	1				
60	<b>1150120410</b>	SCREW	2				
61	<b>1531407122</b>	HOSE	1				sold by the meter
62	<b>1910161013</b>	HOSE	1				Y105840-59100
63	<b>1530808072</b>	HOSE	1				sold by the meter
64	<b>1530808130</b>	HOSE	1				sold by the meter
65	<b>1531115064</b>	HOSE	2				sold by the meter
66	<b>1533120012</b>	BAND	4				
67	<b>1100041030</b>	BOLT	4				
68	<b>0881402595</b>	JOINT	1		224000001~224000020		
69	<b>1700100046</b>	SENSOR	1		224000001~224000020		
70	<b>1533700057</b>	BAND	4				
71	<b>1652241200</b>	BAND	1		224000001~224000020		
72	<b>1531115120</b>	HOSE	1				sold by the meter
76	<b>1531118035</b>	HOSE	2			M	sold by the meter
77	<b>1533120508</b>	BAND	1			M	
78	<b>1420000100</b>	O-RING	1		224000001~224000020		
79	<b>1533120011</b>	BAND	2				
87	<b>1652201008</b>	BAND	1				

U2c021

**ENGINE & ACCESSORIES (3/4) (for GEHL & MUSTANG)**

Item	Part number	Description	Q'ty	Chan.	Serial No.	Serv.	Remarks
0-1	<b>0684001100</b>	RADIATOR ASSY	1				
1	<b>0684001110</b>	· FRAME ASSY	1				
1-1	<b>0684001120</b>	· · FRAME	1				
1-2	<b>1654343073</b>	· · SPONGE	2				sold by the meter
2	<b>0684001130</b>	· HINGE	2				
3	<b>0684000360</b>	· STAY	1				
4	<b>1130040012</b>	· NUT	2				
5	<b>1140020012</b>	· WASHER, spring	2				
6	<b>0880408580</b>	· RUBBER, cushion	2				
7	<b>1140020010</b>	· WASHER, spring	4				
8	<b>1100041016</b>	· BOLT	4				
9	<b>1140020006</b>	· WASHER, spring	4				
10	<b>1100040612</b>	· BOLT	4				
11	<b>1141110006</b>	· WASHER	4				
12	<b>1130040008</b>	· NUT	2				
13	<b>1140020008</b>	· WASHER, spring	4				
14	<b>0003600025</b>	· WASHER	2				
15	<b>1651021030</b>	· RUBBER, cushion	2				
16	<b>0881402180</b>	· PIN	2				
17	<b>1214000016</b>	· PIN, snap	2				
18	<b>1911300340</b>	· RADIATOR & COOLER, oil	1				AKG
18-6	<b>1911300076</b>	· · FITTING, hose	1				
18-7	<b>1911300077</b>	· · NIPPLE	1				
18-8	<b>1911300078</b>	· · CAP, radiator	1				
19	<b>0684000501</b>	· SPONGE	1				
20	<b>0684000502</b>	· SPONGE	1				
21	<b>0684001103</b>	· SPONGE	1				
22	<b>0684001104</b>	· SPONGE	1				
23	<b>1654343058</b>	· SPONGE	2				sold by the meter
24	<b>1100040820</b>	· BOLT	2				
25	<b>1141110008</b>	· WASHER	2				

**U2c030**

**CONTROL BOX; R.H. (for GEHL & MUSTANG; 224000001-224000092)**

Item	Part number	Description	Q'ty	Chan.	Serial No.	Serv.	Remarks
		COVER ASSY (R.H.)					
1	<b>0881431120</b>	GAUGE ASSY, cluster	1				
1-1	<b>0881430901</b>	· ABSORBENT, noise	1				
1-2	<b>0881430902</b>	· ABSORBENT, noise	1				
1-3	<b>0881430903</b>	· ABSORBENT, noise	1				
1-4	<b>1730140930</b>	· GAUGE, cluster	1				
1-4-1	<b>1730140691</b>	· · RELAY	1				12V
1-4-2	<b>1730140782</b>	· · GLASS	1				
1-4-3	<b>1730140785</b>	· · COVER	1				
1-4-4	<b>1730140696</b>	· · BULB	10				14V, 1.4W
1-4-5	<b>1730140788</b>	· · VISOR	1				
1-4-6	<b>1730140694</b>	· · BRACKET	1				
2	<b>0881430802</b>	COVER	1				
3	<b>0881430803</b>	INSULATOR	1				
8	<b>1652231250</b>	BAND	1				
10	<b>1110020820</b>	SCREW, cap	1				
11	<b>1140090008</b>	WASHER, spring	1				
12	<b>1150420614</b>	SCREW	4				
13	<b>1652711698</b>	SCREW	2				
16	<b>0881430805</b>	INSULATOR	1				
17	<b>0882430100</b>	COVER ASSY, sub (R.H.)	1				
17-1	<b>0881430870</b>	· COVER (R.H.)	1				
17-2	<b>0881430880</b>	· HARNESS, wiring	1				
17-3	<b>0881422400</b>	· HARNESS, wiring	1				
17-4	<b>0870431821</b>	· COVER	1				
17-5	<b>1700000010</b>	· SWITCH, lamp	2				
17-7	<b>1700100052</b>	· SWITCH, starter	1				
17-7-1	<b>1700100019</b>	· KEY	1				
17-8	<b>1700550024</b>	· ORNAMENT	1				
17-9	<b>1141810012</b>	· WASHER	2				
	<b>U2c090</b>						

**CONTROL BOX; R.H. (high flow, for GEHL & MUSTANG; 22400093-)**

Item	Part number	Description	Q'ty	Chan.	Serial No.	Serv.	Remarks
		COVER ASSY (R.H.)					
1	<b>0881430950</b>	COVER ASSY	1				
1-1	<b>0881430870</b>	· COVER (R.H.)	1				
1-2	<b>0881430880</b>	· HARNESS, wiring	1				
1-3	<b>0881430960</b>	· HARNESS, wiring	1				
1-4	<b>0870431821</b>	· COVER	1				
1-5	<b>1700000010</b>	· SWITCH, lamp	2				
1-6	<b>1141810012</b>	· WASHER	2				
1-7	<b>1700100052</b>	· SWITCH, starter	1				
1-7-1	<b>1700100019</b>	· KEY	1				
1-8	<b>1700000034</b>	· SWITCH	1				
1-9	<b>0881430970</b>	· HARNESS, wiring	1				
2	<b>0881430802</b>	COVER	1		224000093~224000302		
3	<b>0881430803</b>	INSULATOR	1		224000093~224000122		
	<b>0664300020</b>	INSULATOR	1		224000123~224000302	M	
8	<b>0664301510</b>	GAUGE ASSY, cluster	1			M	
8-1	<b>0881430901</b>	· ABSORBENT, noise	1				
8-2	<b>0881430902</b>	· ABSORBENT, noise	1				
8-3	<b>0881430903</b>	· ABSORBENT, noise	1				
8-4	<b>1730142130</b>	· GAUGE, cluster	1			M	
8-4-1	<b>1730140691</b>	· · RELAY	1				12V
8-4-2	<b>1730140782</b>	· · GLASS	1				
8-4-3	<b>1730140785</b>	· · COVER	1				
8-4-4	<b>1730140696</b>	· · BULB	8				14V, 1.4W
8-4-5	<b>1730140788</b>	· · VISOR	1				
8-4-6	<b>1730140694</b>	· · BRACKET	1				
10	<b>1110020820</b>	SCREW, cap	1				
11	<b>1140090008</b>	WASHER, spring	1				
12	<b>1150420614</b>	SCREW, sems	4				
13	<b>1652711698</b>	SCREW	2		224000093~224000302		
15	<b>1652533015</b>	CAP	1		224000123~224000302		
16	<b>0881430805</b>	INSULATOR	1				
17	<b>1652231250</b>	BAND	1				
	<b>U2c190</b>						

**ENGINE CONTROL**

Item	Part number	Description	Q'ty	Chan.	Serial No.	Serv.	Remarks
		CONTROL ASSY, engine					
1	<b>0664100010</b>	LEVER	1		224000001~224000068		
	<b>0664100720</b>	LEVER	1		224000069~	M	
2	<b>1340010065</b>	END, rod	1				
3	<b>1340010060</b>	END, rod	1				
4	<b>1910253126</b>	SENSOR, accel.	1				Y129938-77800
5	<b>0334120100</b>	BOOT	1				
6	<b>0005006100</b>	ROD	1				
7	<b>1225110018</b>	WASHER, conical	2				
8	<b>1650132050</b>	GRIP	1				
9	<b>1100040840</b>	BOLT	1			M	
10	<b>0684100620</b>	BASE	1		224000069~	M	
11	<b>1130040008</b>	NUT	1				
12	<b>1141550018</b>	WASHER	1		224000001~224000068		
13	<b>0064111700</b>	NUT	2				
14	<b>1100040616</b>	BOLT	2				
15	<b>1140020006</b>	WASHER, spring	4				
16	<b>1141110006</b>	WASHER	3				
17	<b>1130040006</b>	NUT	3				
18	<b>1131540006</b>	NUT	1				
19	<b>1100040820</b>	BOLT	2		224000069~		
20	<b>1140020008</b>	WASHER, spring	2		224000069~		
21	<b>1141110008</b>	WASHER	2		224000069~		
22	<b>1652533017</b>	CAP	3		224000069~	M	
23	<b>0664300040</b>	COVER	1		224000303~	M	
24	<b>0664300030</b>	INSULATOR	1		224000303~	M	
25	<b>1652711698</b>	SCREW	3		224000303~		
	<b>U2c230</b>						

**ELECTRICAL (1/2) (SPK controller type; 224000021-224000229)**

Item	Part number	Description	Q'ty	Chan.	Serial No.	Serv.	Remarks
		ELECTRICAL ASSY (SPK controller type)					
1	X *****	UNIT ASSY, relay	1				see page (2/2)
4	<b>1910264127</b>	E-ECU	1			M	Y129949-75540
7	<b>1130040010</b>	NUT	9				
8	<b>1140020010</b>	WASHER, spring	12				
9	<b>1140330010</b>	WASHER	1				
10	<b>1100041016</b>	BOLT	3				
11	<b>1100040812</b>	BOLT	2				
12	<b>1140020008</b>	WASHER, spring	2				
14	<b>1652231250</b>	BAND	25				
15	<b>1652261225</b>	BAND	1				
16	<b>1150420614</b>	SCREW	1				
18	<b>1652241400</b>	BAND	3				
20	<b>1703500712</b>	HORN	1				
21	<b>1703700013</b>	BUZZER	1				
23	<b>0882420220</b>	RUBBER	1				
25	<b>0872433150</b>	TUBE	10				
27	<b>1100040610</b>	BOLT	7				
28	<b>1130040006</b>	NUT	5				
29	<b>1140020006</b>	WASHER, spring	12				
30	<b>0003600110</b>	WASHER	9				
31	<b>0003608252</b>	WASHER	3				
37	<b>1711900097</b>	CLAMP	3				
38	<b>1711900071</b>	CLAMP	7				
39	<b>1711900072</b>	CLAMP	2				
40	<b>1134831035</b>	NUT	1				
41	<b>1730142090</b>	CONTROLLER	1			M	
42	<b>0654203510</b>	BRACKET	1			M	
43	<b>0664202400</b>	HARNESS, wiring	1			M	
44	<b>1652060051</b>	BUSHING	1			M	
45	<b>1652251002</b>	BAND	2			M	

**U2c260**

**ELECTRICAL (cab)**

Item	Part number	Description	Q'ty	Chan.	Serial No.	Serv.	Remarks
		ELECTRICAL ASSY					
		ELECTRICAL ASSY (for EU)					
1	<b>0880427810</b>	HARNESS, wiring	1				
	<b>0882421410</b>	HARNESS, wiring	1				for EU
2	<b>1140330010</b>	WASHER	1				
3	<b>1652231250</b>	BAND	10				
4	<b>1704300007</b>	SWITCH, wiper	1				
	<b>1704300007</b>	SWITCH, wiper	2				for EU
5	<b>1141810012</b>	WASHER	1				
	<b>1141810012</b>	WASHER	2				for EU
	<b>U3c220</b>						

**MAINTENANCE LIGHT SOCKET**

Item	Part number	Description	Q'ty	Chan.	Serial No.	Serv.	Remarks
		SOCKET ASSY, maintenance light					
1	<b>0394203100</b>	SOCKET ASSY	1				
2	<b>1652231250</b>	BAND	1				
	<b>T8c110</b>						

**VALVE & ACCESSORIES (2/2)**

Item	Part number	Description	Q'ty	Chan.	Serial No.	Serv.	Remarks
		VALVE ASSY, control					
		VALVE ASSY, control (high flow)					
		VALVE ASSY, control (for EU)					
		VALVE ASSY, control (for EU, high flow)					
3	X *****	VALVE SUB ASSY	1				
3-1	<b>1501750002</b>	· PLUG	1				
	<b>1420010110</b>	· · O-RING	1				
3-2	<b>1512340004</b>	· TEE	1				
	<b>1420010180</b>	· · O-RING	1				
3-3	<b>1512370010</b>	· TEE	1				
	<b>1420010110</b>	· · O-RING	1				
3-4	<b>1512370011</b>	· TEE	2				
	<b>1420010110</b>	· · O-RING	1				
3-5	<b>1515600200</b>	· ADAPTOR	1				
	<b>1420010110</b>	· · O-RING	1				
3-6	<b>1515010040</b>	· ELBOW	1				
	<b>1420010110</b>	· · O-RING	1				
3-7	<b>1515100112</b>	· ELBOW	1				
	<b>1420010180</b>	· · O-RING	1				
3-8	<b>1901748100</b>	· VALVE, sub	1				
5	X *****	VALVE ASSY, solenoid (high flow)	1				
5-1	<b>1901753600</b>	· VALVE, solenoid	1				high flow
5-1-2	<b>1901753602</b>	· · SOLENOID	1				high flow
5-1-3	<b>1901753603</b>	· · COIL	1				high flow
5-2	<b>0007213050</b>	· BUSHING	1				high flow
5-3	<b>0695000063</b>	· TEE	1				high flow
5-4	<b>1512374012</b>	· TEE	1				high flow
	<b>1420010240</b>	· · O-RING	1				
6	X *****	VALVE ASSY, solenoid	1				
6-1	<b>1901753600</b>	· VALVE, solenoid	1				
6-1-2	<b>1901753602</b>	· · SOLENOID	1				
6-1-3	<b>1901753603</b>	· · COIL	1				
6-2	<b>1515600574</b>	· ADAPTOR	1				
	<b>1420010240</b>	· · O-RING	1				
6-3	<b>1512374011</b>	· TEE	1				
	<b>1420010240</b>	· · O-RING	1				
9	<b>0665001090</b>	BRACKET	1				
10	<b>0882500100</b>	BRACKET	1				
11	X *****	VALVE SUB ASSY (high flow)	1				
11-1	<b>1901039500</b>	· VALVE, control	1				high flow
11-2	<b>0007203007</b>	· ADAPTOR	1				high flow
	<b>1420310908</b>	· · O-RING	1				high flow
11-3	<b>0007203058</b>	· ADAPTOR	1				high flow
	<b>1420010180</b>	· · O-RING	1				high flow
11-4	<b>1515600200</b>	· ADAPTOR	1				high flow
	<b>1420010110</b>	· · O-RING	1				high flow
11-5	<b>1515600202</b>	· ADAPTOR	1				high flow
	<b>1420010180</b>	· · O-RING	1				high flow
12	X *****	VALVE SUB ASSY (high flow)	1				
12-1	<b>1901752100</b>	· VALVE, proportional control	1				high flow
12-2	<b>1515012040</b>	· ELBOW	1				high flow
	<b>1420010110</b>	· · O-RING	1				high flow
12-3	<b>1512370010</b>	· TEE	2				high flow
	<b>1420010110</b>	· · O-RING	1				high flow
12-4	<b>1512375004</b>	· ELBOW (with filter)	1				high flow
	<b>1420010110</b>	· · O-RING	1				high flow
12-5	<b>0007213028</b>	· BUSHING	1				high flow
	<b>1420010110</b>	· · O-RING	1				high flow
13	X *****	VALVE SUB ASSY	1				
13-1	<b>1901752100</b>	· VALVE, proportional control	1				
13-2	<b>1515012040</b>	· ELBOW	2				
	<b>1420010110</b>	· · O-RING	1				
13-3	<b>1512370010</b>	· TEE	1				
	<b>1420010110</b>	· · O-RING	1				
13-4	<b>1512375004</b>	· ELBOW (with filter)	1				

**PIPING (2/2) (high flow)**

Item	Part number	Description	Q'ty	Chan.	Serial No.	Serv.	Remarks
		PIPING ASSY, upper					
		PIPING ASSY, upper (for EU)					
1	<b>0687000010</b>	HOSE ASSY	1				
2	<b>0687000020</b>	HOSE ASSY	1				
3	<b>0687000030</b>	HOSE ASSY	1				
4	<b>0687000040</b>	HOSE ASSY	1				
10	<b>0687001100</b>	HOSE ASSY	1				18015-77072
12	<b>0882700120</b>	HOSE ASSY	1				18010-22070
14	<b>0882700140</b>	HOSE ASSY	1				18010-22148
15	<b>0687001150</b>	HOSE ASSY	1				18010-22163
17	<b>0882700170</b>	HOSE ASSY	1				18010-22094
18	<b>0687001180</b>	HOSE ASSY	1				18010-24035
19	<b>0687001190</b>	HOSE ASSY	1				18010-91046
20	<b>0687001200</b>	HOSE ASSY	1				
21	<b>0687001210</b>	HOSE ASSY	1				
22	<b>0687000220</b>	HOSE ASSY	1				18010-27074
31	X *****	FILTER ASSY	1				
31-1	<b>1551102500</b>	· FILTER	1				
31-1-1	<b>1551101001</b>	· · ELEMENT	1				
31-1-2	<b>1551101003</b>	· · CASE	1				
31-1-4	<b>1420100600</b>	· · O-RING	1				
31-1-5	<b>1551102505</b>	· · SWITCH, pressure	1				
31-2	<b>1515010042</b>	· ELBOW	1				
	<b>1420010180</b>	· · O-RING	1				
31-3	<b>1515100112</b>	· ELBOW	1				
	<b>1420010180</b>	· · O-RING	1				
31-4	<b>0007213055</b>	· BUSHING	1				
34	<b>1100041095</b>	BOLT	2				except for EU
37	<b>1141110010</b>	WASHER	2				for EU
39	<b>1100041025</b>	BOLT	8				
45	<b>1130040010</b>	NUT	2				for EU
46	<b>0003600020</b>	WASHER	8				
50	<b>1100141005</b>	BOLT	2				for EU
58	<b>0697001580</b>	GROMMET	2				
59	<b>1140020010</b>	WASHER, spring	10				
	<b>1140020010</b>	WASHER, spring	8				for EU
60	<b>0687001600</b>	COVER (L.H.)	1				
61	<b>0687001610</b>	COVER (R.H.)	1				
62	<b>1652241300</b>	BAND	2				
69	<b>0882702480</b>	RUBBER	4				for EU

**U2d060**

**FUEL TANK & FUEL PIPING**

Item	Part number	Description	Q'ty	Chan.	Serial No.	Serv.	Remarks
40	<b>1910199034</b>	PUMP, feed	1				Y129612-52100
41	<b>1910186033</b>	SEPARATOR, water	1				Y129906-55700
43	<b>1652201008</b>	BAND	1				
44	<b>1531207145</b>	HOSE	1				sold by the meter
45	<b>1531207084</b>	HOSE	1				sold by the meter
46	<b>1531115135</b>	PROTECTOR	1				sold by the meter
47	<b>1531115074</b>	PROTECTOR	1				sold by the meter
	<b>U2d101</b>						

<b>FLOOR FRAME (throttle pedal type)</b>						
Item	Part number	Description	Q'ty	Chan.	Serial No.	Serv. Remarks
		FLOOR ASSY				
1	0683500250	COVER (R.H.)	1			M
2	0882350740	COVER (L.H.)	1			
3	0683501030	PLATE	1			M
4	0683501040	MAT, floor	1			M
5	0880354650	COVER	1			
6	0881351500	STAY	1			
7	0881351010	STAY	1			
8	0881351020	ABSORBENT, noise	1			
10	0563218500	COVER	2			
11	0563219700	REST, foot	2			
12	1100040820	BOLT	22			
14	1140020008	WASHER, spring	22			
15	1140020010	WASHER, spring	4			
16	1141110010	WASHER	4			
17	0003608252	WASHER	8			
18	1141110008	WASHER	10			
19	0880821355	SHEET	1			
20	1652231250	BAND	1			
21	1653916007	TRIM	1			sold by the meter
22	1654606048	TRIM	1			sold by the meter
23	1653916036	TRIM	1			sold by the meter
24	1100041020	BOLT	4			
25	1653916043	TRIM	1			sold by the meter
26	0880353526	SPONGE	1			
27	0880353527	SPONGE	1			
30	1654623010	TRIM	2			sold by the meter
31	0003608003	WASHER	4			
32	1652053600	GROMMET	1			
34	1654355022	SPONGE	1			sold by the meter
35	1654355013	SPONGE	1			M sold by the meter
36	1654354074	SPONGE	1			sold by the meter

U2e120

**SEAT SWITCH (224000001-224000122)**

Item	Part number	Description	Q'ty	Chan.	Serial No.	Serv.	Remarks
0	<b>0882340000</b>	SWITCH ASSY, seat	1				
1	<b>1914100086</b>	· SWITCH KIT, seat	1				
2	<b>0882340200</b>	· BRACKET	1				
3	<b>0881422540</b>	· HARNESS, wiring	1				
4	<b>0882340100</b>	· HARNESS, wiring	1				
5	<b>1711900074</b>	· STICKER	5				
6	<b>1130040006</b>	· NUT	1				
7	<b>1140020006</b>	· WASHER, spring	1				
8	<b>1141110006</b>	· WASHER	1				
9	<b>1652231250</b>	· BAND	6				
10	<b>1654314005</b>	· SPONGE	1				sold by the meter
11	<b>1711900062</b>	· RELAY	1				

**T9e120**

**CANOPY (1/3) (for US)**

Item	Part number	Description	Q'ty	Chan.	Serial No.	Serv.	Remarks
0	<b>0880845300</b>	CANOPY ASSY	1		224000001~224000020		
	<b>0688401000</b>	CANOPY ASSY	1		224000021~	M	
1	<b>0880865200</b>	· CANOPY	1		224000001~224000020		
	<b>0688401100</b>	· CANOPY	1		224000021~	M	
9	<b>0880865103</b>	· GLASS	1				
10	<b>0880865104</b>	· GLASS	1				
11	<b>1653916320</b>	· TRIM	2				sold by the meter
12	<b>1653916148</b>	· TRIM	2				sold by the meter
13	<b>1653916120</b>	· TRIM	2				sold by the meter
14	<b>1654231273</b>	· H-RUBBER	1				sold by the meter
15	<b>1654231195</b>	· H-RUBBER	1				sold by the meter
61	<b>1654630240</b>	· TRIM	1				sold by the meter
62	<b>1654630060</b>	· TRIM	2				sold by the meter
68	<b>0880865129</b>	· GUARD	1				
78	<b>0881842010</b>	· ABSORBENT, noise	1				
79	<b>0880865133</b>	· ABSORBENT, noise	1				
80	<b>0880865134</b>	· ABSORBENT, noise	1				
81	<b>0880865135</b>	· ABSORBENT, noise	1				
82	<b>0880865136</b>	· ABSORBENT, noise	1				
83	<b>0880865137</b>	· ABSORBENT, noise	1				
85	<b>0880865138</b>	· GRIP	1				
86	<b>0880865139</b>	· RING	1				
87	<b>1654639203</b>	· TRIM	1			M	sold by the meter
91	<b>0880865140</b>	· SEAL	2				
93	<b>0880865141</b>	· SEAL	1		224000001~224000020		
94	<b>0880865142</b>	· GUARD	1				
95	<b>0880865143</b>	· GUARD	1				
97	<b>1120990820</b>	· BOLT	4				
98	<b>1120990816</b>	· BOLT	37				
99	<b>1654011705</b>	· WASHER	41				
100	<b>0880865144</b>	· WASHER	8				
101	<b>0880865145</b>	· PLATE	8				
102	<b>0880865146</b>	· COVER	2				
109	<b>0880865150</b>	· RIVET	8				
126	<b>1653916037</b>	· TRIM	1				sold by the meter
131	<b>1653303010</b>	· CAP	2				
136	<b>0880845301</b>	· PACKING	1				
137	<b>0880845302</b>	· PLATE	1				
141	<b>0880845303</b>	· PLATE	4				
142	<b>0880845304</b>	· PLATE	2				
143	<b>0880845305</b>	· PLATE	2				
144	<b>0880845306</b>	· PLATE	2				
146	<b>0668600240</b>	· SPONGE	1		224000021~	M	
147	<b>0668600250</b>	· SPONGE	1		224000021~	M	
148	<b>0668601009</b>	· SPONGE	2		224000021~	M	
149	<b>1654605088</b>	· RUBBER	1		224000021~	M	sold by the meter
150	<b>1654011966</b>	· CAP	2		224000021~	M	

**U2e200**

**CANOPY (3/3) (for EU)**

Item	Part number	Description	Q'ty	Chan.	Serial No.	Serv.	Remarks
0	<b>0880845600</b>	CANOPY ASSY	1				
3	<b>0880845670</b>	· HARNESS, wiring	1				
4	<b>1652221050</b>	· CLIP	4				
17	<b>1703001700</b>	· LAMP, room	1				
17-1	<b>1703001701</b>	· · BULB	1				
18	<b>1150410412</b>	· SCREW	2				
19	<b>1652042030</b>	· GROMMET	1				
20	<b>1703006600</b>	· LAMP, ASSY	2				
20-1	<b>1703006605</b>	· · BULB	1				
21	<b>1652000602</b>	· GROMMET	2				
22	<b>1100091020</b>	· BOLT	2				
23	<b>1654011706</b>	· WASHER	2				
56	<b>1130040010</b>	· NUT	1				
57	<b>1654011702</b>	· GROMMET	1				
59	<b>1654011700</b>	· GROMMET	1				
	<b>T8e241</b>						

<b>CAB (1/6)</b>						
Item	Part number	Description	Q'ty	Chan.	Serial No.	Serv. Remarks
0	<b>0668601000</b>	CAB ASSY	1			
	<b>0668602000</b>	CAB ASSY (for EU)	1			
68	<b>0880865129</b>	· GUARD	1			
78	<b>0881842010</b>	· ABSORBENT, noise	1			
79	<b>0880865133</b>	· ABSORBENT, noise	1			
80	<b>0880865134</b>	· ABSORBENT, noise	1			
81	<b>0880865135</b>	· ABSORBENT, noise	1			
82	<b>0880865136</b>	· ABSORBENT, noise	1			
83	<b>0880865137</b>	· ABSORBENT, noise	1			
87	<b>1654639203</b>	· TRIM	1			M sold by the meter
94	<b>0880865142</b>	· GUARD	1			
95	<b>0880865143</b>	· GUARD	1			
97	<b>1120990820</b>	· SCREW	4			
98	<b>1120990816</b>	· SCREW	33			
99	<b>1654011705</b>	· WASHER	37			
100	<b>0880865144</b>	· WASHER	8			
101	<b>0880865145</b>	· PLATE	8			
102	<b>0880865146</b>	· COVER	2			
109	<b>0880865150</b>	· RIVET	8			
126	<b>1653918037</b>	· TRIM	1			M sold by the meter
131	<b>1653303010</b>	· CAP	2			
169	<b>0668601009</b>	· SPONGE	2			M
	<b>U1e170</b>					

CLICK HERE TO **DOWNLOAD** THE COMPLETE MANUAL

- Thank you very much for reading the preview of the manual.
- You can download the complete manual from: [www.heydownloads.com](http://www.heydownloads.com) by clicking the link below



- Please note: If there is no response to CLICKING the link, please download this PDF first and then click on it.

CLICK HERE TO **DOWNLOAD** THE COMPLETE MANUAL

**CAB (6/6) (front door)**

Item	Part number	Description	Q'ty	Chan.	Serial No.	Serv.	Remarks
0	<b>0668601200</b>	DOOR ASSY, front	1			M	
1	<b>0668601210</b>	· DOOR, front	1			M	
2	<b>0880865301</b>	· GLASS	1			M	
3	<b>0880865302</b>	· MOTOR, wiper	1			M	
4	<b>0880865303</b>	· ARM, wiper	1			M	
5	<b>0880865304</b>	· BLADE	1			M	
6	<b>0880865305</b>	· ROLLER	4			M	
7	<b>0880865306</b>	· BOLT	2			M	
8	<b>1130040012</b>	· NUT	2				
9	<b>1654615210</b>	· DAM	2			M	sold by the meter
10	<b>1654631054</b>	· SEAL	1			M	sold by the meter
11	<b>1653916045</b>	· TRIM	2			M	sold by the meter
12	<b>0880865307</b>	· BOLT	1			M	
13	<b>1654011707</b>	· WASHER	1			M	
14	<b>0880865308</b>	· PLATE	1			M	
15	<b>1100090620</b>	· BOLT	2			M	
16	<b>0880865309</b>	· SHIM	4			M	
17	<b>0880865310</b>	· COLLAR	1			M	
18	<b>0880865311</b>	· COLLAR	1			M	
19	<b>0880865312</b>	· HANDLE	2			M	
20	<b>0880865313</b>	· NUT	2			M	
21	<b>0880865314</b>	· PACKING	4			M	
22	<b>0880865315</b>	· WASHER	2			M	
24	<b>0880865316</b>	· SHEET	2			M	
25	<b>0880865317</b>	· LATCH	1			M	
26	<b>1100090820</b>	· BOLT	2				
27	<b>1654011705</b>	· WASHER	2				
28	<b>1654615013</b>	· DAM	1			M	sold by the meter
29	<b>1654615020</b>	· DAM	1			M	sold by the meter
30	<b>1150420620</b>	· SCREW	2			M	
31	<b>1130190012</b>	· NUT	1			M	
32	<b>1150410620</b>	· SCREW	2			M	

**U1e220**

**CAB KIT (5/5) (224000021-)**

Item	Part number	Description	Q'ty	Chan.	Serial No.	Serv.	Remarks
0	<b>0882860500</b>	CAB KIT	1			M	
155	<b>1711910290</b>	· TANK	1				
155-1	<b>1711910291</b>	· · BRACKET	1				
157	<b>1150410612</b>	· SCREW	2				
160	<b>1703210770</b>	· PROTECTOR	1			M	
161	<b>1703220750</b>	· PROTECTOR	1				sold by the meter
162	<b>1652231140</b>	· BAND	2				
163	<b>1653900060</b>	· SPRING, gas	2				
164	<b>0880427810</b>	· HARNESS, wiring	1				
165	<b>1140330010</b>	· WASHER	1				
166	<b>1652231250</b>	· BAND	10				
167	<b>1704300007</b>	· SWITCH, wiper	1				
168	<b>1141810012</b>	· WASHER	1				

**U2e190**

**AIR CONDITIONER (2/5) (condenser)**

Item	Part number	Description	Q'ty	Chan.	Serial No.	Serv.	Remarks
0	<b>0664600200</b>	CONDENSER ASSY	1				
1	<b>1911508431</b>	· HOSE ASSY	1				
	<b>1911505601</b>	· · O-RING	1				
2	<b>1911508432</b>	· HOSE ASSY	1				
	<b>1911505601</b>	· · O-RING	1				
3	<b>1911505943</b>	· HOSE ASSY	1				
	<b>1911505602</b>	· · O-RING	1				
4	<b>1911508424</b>	· HOSE ASSY	1				
	<b>1911505603</b>	· · O-RING	1				
5	<b>1911508311</b>	· DRYER	1				
6	<b>1911505514</b>	· SWITCH, pressure	1				
7	<b>1911506080</b>	· CONDENSER ASSY	1				see page (4/5)
8	<b>1911508410</b>	· HARNESS, wiring	1				
8-1	<b>1911506041</b>	· · RELAY	2				
10	<b>0880465610</b>	· BRACKET	1				
11	<b>1100040820</b>	· BOLT	6				
12	<b>1140020008</b>	· WASHER, spring	6				
13	<b>1141110008</b>	· WASHER	6				
14	<b>1652201008</b>	· BAND	4				
15	<b>1652231250</b>	· BAND	10				
16	<b>1711900071</b>	· CLAMP	1				
17	<b>1140020010</b>	· WASHER, spring	1				
18	<b>1130040010</b>	· NUT	1				

**U1e130**

**QUICK HITCH**

Item	Part number	Description	Q'ty	Chan.	Serial No.	Serv.	Remarks
0	<b>0686100000</b>	HITCH, quick (for EU)	1				
	<b>0686101000</b>	HITCH, quick (for US)	1				
1	<b>0686100100</b>	· BRACKET	1				for EU
	<b>0686100200</b>	· BRACKET	1				for US
2	<b>0881612040</b>	· LEVER(L.H.)	1				
3	<b>0881612050</b>	· LEVER(R.H.)	1				
4	<b>0881612150</b>	· PIN	2				
5	<b>0881612060</b>	· YOKE	2				
6	<b>0881612070</b>	· WASHER	2				
7	<b>0880612070</b>	· PIN	2				
8	<b>0881612160</b>	· PIPE	2				
9	<b>1560001000</b>	· FITTING, grease	2				
10	<b>0007000016</b>	· SPRING	2				
11	<b>0007000119</b>	· SPRING	2				
12	<b>1132630012</b>	· NUT	2				
13	<b>1210013225</b>	· PIN, split	2				
14	<b>0003600025</b>	· WASHER	4				
15	<b>1140120010</b>	· WASHER, spring	2				
16	<b>1100041020</b>	· BOLT	4				
17	<b>1213001250</b>	· PIN, spring	2				
18	<b>1225120018</b>	· WASHER, conical	2				
	<b>U2f021</b>						

**PIPING; ARM (2/2)**

Item	Part number	Description	Q'ty	Chan.	Serial No.	Serv.	Remarks
		PIPING ASSY					
7	<b>0882732010</b>	PIPE	1				
8	<b>0882732020</b>	PIPE	1				
10	<b>0882732030</b>	PIPE	1				
14	<b>1100041016</b>	BOLT	1				
16	<b>1100041025</b>	BOLT	6				
18	<b>1140020010</b>	WASHER, spring	7				
20	<b>1141110010</b>	WASHER	1				
22	<b>0882730220</b>	HOSE ASSY	1				18015-70070
38	<b>0882732040</b>	HOSE ASSY	1				
39	<b>0881733550</b>	CLAMP	1			M	
40	<b>0880738130</b>	CLAMP	2			M	
41	<b>0880738140</b>	RUBBER	1				
42	<b>0880738150</b>	RUBBER	2				
45	<b>0687301450</b>	HOSE ASSY	1				18010-23122
51	<b>1501750004</b>	PLUG	2				
	<b>1420010180</b>	· O-RING	1				
52	<b>1501750003</b>	PLUG	1				
	<b>1420010140</b>	· O-RING	1				
54	<b>1711900071</b>	CLAMP	1				
65	<b>1652533018</b>	CAP	2				
	<b>U2f061</b>						

**PIPING; ARM (2/2) (high flow, with coupler, hydraulic quick hitch type)**

Item	Part number	Description	Q'ty	Chan.	Serial No.	Serv.	Remarks
		PIPING ASSY (with coupler)					
		PIPING ASSY (hydraulic quick hitch type)					
		PIPING ASSY (for US)					
7	<b>0687300070</b>	PIPE	1				with coupler
8	<b>0687300080</b>	PIPE	1				
10	<b>0882732030</b>	PIPE	1				with coupler
12	<b>1110040865</b>	SCREW, cap	2				
14	<b>1100041016</b>	BOLT	1				
15	<b>1100041020</b>	BOLT	2				
16	<b>1100041025</b>	BOLT	6				
17	<b>1140020008</b>	WASHER, spring	2				
18	<b>1140020010</b>	WASHER, spring	9				
19	<b>1141110008</b>	WASHER	2				
20	<b>1141110010</b>	WASHER	1				
27	<b>0687307270</b>	PIPE (hydraulic quick hitch type)	1				for US
28	<b>0687307280</b>	PIPE (hydraulic quick hitch type)	1				for US
36	<b>0667300590</b>	BRACKET (hydraulic quick hitch type)	1				for US
38	<b>0882733380</b>	HOSE ASSY	1				18015-50069
39	<b>0881733550</b>	CLAMP	1			M	
40	<b>0880738130</b>	CLAMP	2			M	
41	<b>0880738140</b>	RUBBER	1				
42	<b>0880738150</b>	RUBBER	2				
43	<b>0882733430</b>	HOSE ASSY	1				18015-50069
45	<b>0687301450</b>	HOSE ASSY	1				18010-23122
50	<b>1130040008</b>	NUT	2				
53	<b>1501750002</b>	PLUG	2				for US
	<b>1420010110</b>	· O-RING	1				
54	<b>1711900071</b>	CLAMP	1				
55	<b>0880738160</b>	BRACKET	1				with coupler
56	<b>1901747000</b>	COUPLER, block	1				
56-1	<b>1901747001</b>	· ADAPTOR	2				
56-2	<b>1901747002</b>	· ADAPTOR	1				
56-3	<b>1901747003</b>	· ADAPTOR	1				
56-4	<b>1901747004</b>	· ADAPTOR	1				
57	<b>0007236044</b>	ADAPTOR	2				
58	<b>0007203017</b>	NIPPLE	1				
	<b>1420310906</b>	· O-RING	1				
59	<b>1511410003</b>	ADAPTOR	1				
	<b>1420010140</b>	· O-RING	1				
60	<b>1420310906</b>	O-RING	1				
61	<b>0003608252</b>	WASHER	2				
62	<b>0003600020</b>	WASHER	2				

U2f111

TL240 (P-TL240BAB) BU2Z002-1 S/N 22400001-  
Dutch

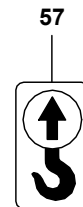
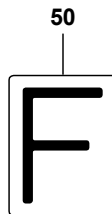
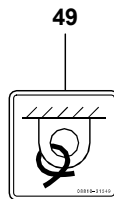
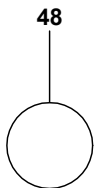
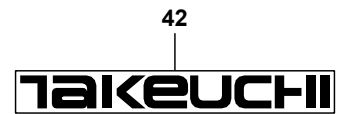
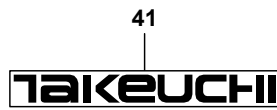
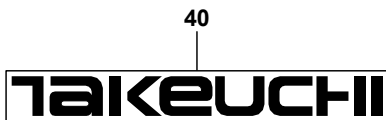
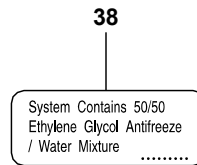
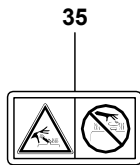
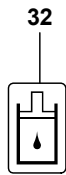
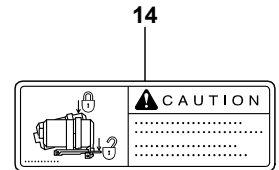
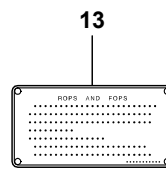
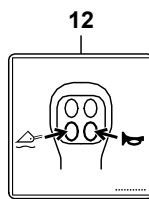
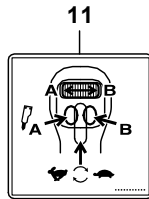
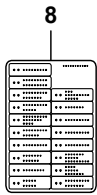
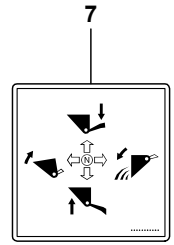
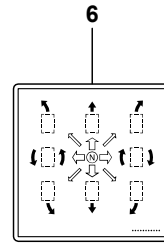
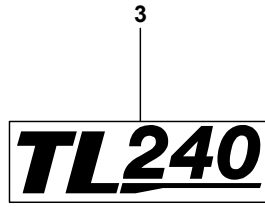
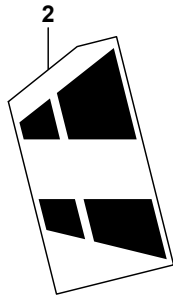
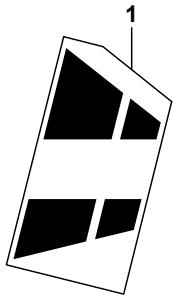

TL240 (P-TL240BAB) BU2Z002-1 S/N 22400001-  
for US

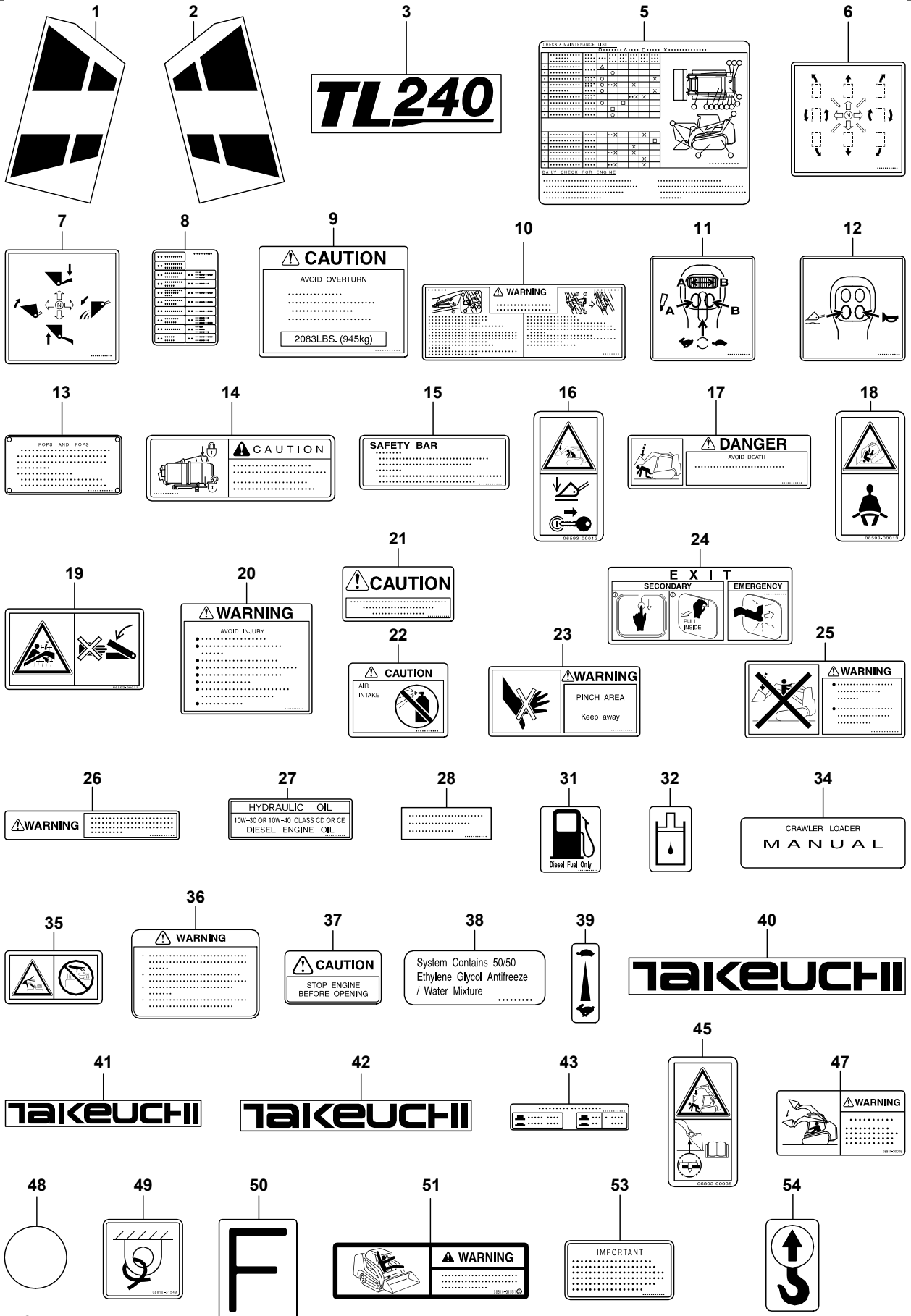

U2G120

S=free

TL240 (P-TL240BAB) BU2Z002-1 S/N 22400001-  
Italian

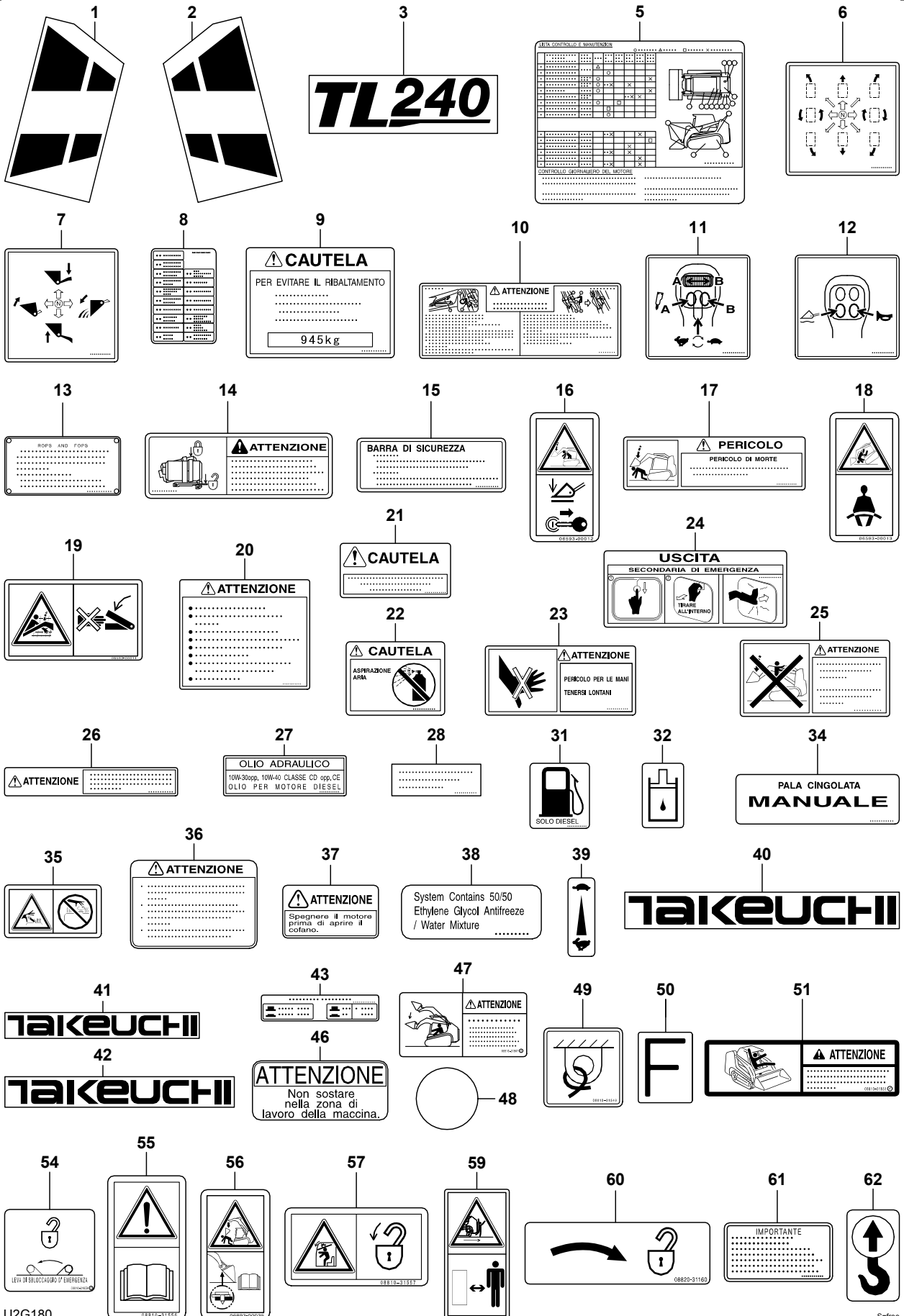

U2G180

Ref. U2G150

S=free

DECAL (cab)							
Item	Part number	Description	Q'ty	Chan.	Serial No.	Serv.	Remarks
43	<b>0881030243</b>	· DECAL (French)	1			M	
	<b>0881030343</b>	· DECAL (Italian)	1			M	
	<b>0881030543</b>	· DECAL (German)	1			M	
	<b>0881032224</b>	· DECAL (Russian)	1			M	
44	X *****	· SCREW	16				
45	X *****	· DECAL	1				except for US, Russian
46	<b>0359309100</b>	· DECAL (French)	1			M	
	<b>0359310100</b>	· DECAL (Italian)	1			M	
	<b>0359308100</b>	· DECAL (German)	1			M	
	<b>0399356001</b>	· DECAL (Russian)	1			M	
47	<b>0881030046</b>	· DECAL (English)	2			M	
	<b>0881031747</b>	· DECAL (French)	2			M	
	<b>0881031847</b>	· DECAL (Italian)	2			M	
	<b>0881031947</b>	· DECAL (German)	2			M	
	<b>0881032225</b>	· DECAL (Russian)	2			M	
48	<b>0874030360</b>	· DECAL	2			M	
49	<b>0881031549</b>	· DECAL	4			M	
50	<b>0399300400</b>	· DECAL	1			M	
51	<b>0881031551</b>	· DECAL (English)	1			M	
	<b>0881031751</b>	· DECAL (French)	1			M	
	<b>0881031851</b>	· DECAL (Italian)	1			M	
	<b>0881031951</b>	· DECAL (German)	1			M	
	<b>0881032226</b>	· DECAL (Russian)	1			M	
52	X *****	· DECAL	1				except for US
53	X *****	· DECAL	1				except for US
54	<b>0881031554</b>	· DECAL (English)	1			M	
	<b>0881031754</b>	· DECAL (French)	1			M	
	<b>0881031854</b>	· DECAL (Italian)	1			M	
	<b>0881031954</b>	· DECAL (German)	1			M	
	<b>0881032227</b>	· DECAL (Russian)	1			M	
55	<b>0881031556</b>	· DECAL	1			M	
56	<b>0689300035</b>	· DECAL	1			M	
57	<b>0881031557</b>	· DECAL	1			M	
59	<b>0882031159</b>	· DECAL	2			M	except for US
60	<b>0882031160</b>	· DECAL	1			M	
61	<b>0339376240</b>	· DECAL (English)	1			M	
	<b>0339379440</b>	· DECAL (French)	1			M	
	<b>0339379540</b>	· DECAL (Italian)	1			M	
	<b>0339376340</b>	· DECAL (German)	1			M	
	<b>0579300613</b>	· DECAL (Russian)	1			M	
62	<b>0399300500</b>	· DECAL	2				
	<b>U2g150</b>						

**PAINTED COLOR (for GEHL & MUSTANG)**

Item	Part number	Description	Q'ty	Chan.	Serial No.	Serv.	Remarks
		PAINTED COLOR					
1	<b>1919060177</b>	GEHL YELLOW	1				
	<b>1919069177</b>	GEHL YELLOW	1				spray
2	<b>1919060180</b>	GEHL GRAY	1				
	<b>1919069180</b>	GEHL GRAY	1				spray
3	<b>1919060105</b>	RED	1				
	<b>1919069105</b>	RED	1				spray
4	<b>1919060103</b>	BLACK	1				
	<b>1919069103</b>	BLACK	1				spray
	<b>U2g030</b>						

**HANDLE (with slide switch)**

Item	Part number	Description	Q'ty	Chan.	Serial No.	Serv.	Remarks
0	<b>1901740410</b>	HANDLE ASSY	1				
1	<b>1122400312</b>	· SCREW	4				
2	<b>1901740417</b>	· CASE	1				
3	<b>1901740418</b>	· CAM	1				
4	<b>1901740401</b>	· PLATE	1				
5	<b>1901740402</b>	· BUTTON	1				
6	<b>1901740403</b>	· BRACKET	1				
7	<b>1901740404</b>	· CLIP	1				
8	<b>1901740405</b>	· PISTON	2				
9	<b>1901740406</b>	· SPRING	2				
10	<b>1901740407</b>	· CAP	1				
11	<b>1150010312</b>	· SCREW	1				
12	<b>1122400306</b>	· SCREW	3				
13	<b>1901740408</b>	· SWITCH	1				
14	<b>1901740409</b>	· SWITCH	2				
15	<b>1901740411</b>	· COVER	1				
16	<b>1901740412</b>	· CAP	2				
17	<b>1901740446</b>	· RECEPTACLE	1				
18	<b>1901740447</b>	· WEDGE	1				
19	<b>1901740413</b>	· PIN	8				
20	<b>1901740414</b>	· PROTECTOR	1				
21	<b>1901740415</b>	· BAND	1				

**L3h490**

**SOLENOID VALVE; 1 BLOCK**

Item	Part number	Description	Q'ty	Chan.	Serial No.	Serv.	Remarks
0	<b>1901752000</b>	VALVE ASSY, solenoid	1				
2	<b>1901752002</b>	· VALVE, solenoid	1				
3	<b>1901752003</b>	· COIL	2				
4	<b>1901741704</b>	· PLUG	1				

**U1h020**

**TRAVEL MOTOR (1/3) (reduction sec.)**

Item	Part number	Description	Q'ty	Chan.	Serial No.	Serv.	Remarks
0	<b>1903126500</b>	MOTOR ASSY, travel	1				
0-1	X *****	· GEAR, reduction	1				X1912908800
1	<b>1912907801</b>	· · GEAR, ring	1				
2	<b>1912907802</b>	· · COVER	1				
3	<b>1912907803</b>	· · CARRIER	1				
4	<b>1912907804</b>	· · GEAR	1				
5	<b>1912907805</b>	· · GEAR	1				
6	<b>1912907806</b>	· · GEAR	3				
7	<b>1912907807</b>	· · GEAR	4				
8	<b>1912907809</b>	· · NUT	1				
9	<b>1912907810</b>	· · PLATE KIT, stopper	1				
10	<b>1912907811</b>	· · · PLAT, stopper	1				t=6.4mm
11	<b>1912907812</b>	· · · PLAT, stopper	1				t=6.8mm
12	<b>1912907813</b>	· · · PLAT, stopper	1				t=6.8mm
13	<b>1912907814</b>	· · · PLAT, stopper	1				t=7.0mm
14	<b>1912907815</b>	· · · PLAT, stopper	1				t=7.2mm
15	<b>1912907818</b>	· · PLAT, stopper	1				
16	<b>1912907819</b>	· · RING, snap	1				
17	<b>1912907820</b>	· · WASHER	4				
18	<b>1912907821</b>	· · BEARING	2				
19	<b>1912907822</b>	· · BEARING	3				
20	<b>1912907824</b>	· · BEARING	4				
21	<b>1912907826</b>	· · SEAL KIT, floating	1				
22	<b>1912907827</b>	· · SCREW, cap	4				
23	<b>1912907828</b>	· · BOLT	3				
24	<b>1100040625</b>	· · BOLT	12				
25	<b>1141120006</b>	· · WASHER	12				
26	<b>1501810003</b>	· · PLUG	2				
27	<b>1912907830</b>	· · PLUG	3				

**U2h010**

**HYDRAULIC PUMP (3/5)**

Item	Part number	Description	Q'ty	Chan.	Serial No.	Serv.	Remarks
0	<b>1902023200</b>	PUMP, hydraulic	1				
2	<b>1902016531</b>	· PLUG ASSY	2				
3	<b>1902010033</b>	· PLUG ASSY	1				
4	<b>1902020733</b>	· GASKET	1				
5	<b>1110040620</b>	· SCREW, cap	4				
6	<b>1902023220</b>	· COVER	1				
7	<b>1902018807</b>	· ORIFICE	2				
33	<b>1902016531</b>	· PLUG ASSY	2				
34	<b>1902010033</b>	· PLUG ASSY	1				
35	<b>1902020733</b>	· GASKET	1				
36	<b>1110040620</b>	· SCREW, cap	4				
37	<b>1902023220</b>	· COVER	1				
38	<b>1902018807</b>	· ORIFICE	2				
93	<b>1902017736</b>	· ADJUSTER	1				
94	<b>1902016552</b>	· NUT	1				
95	<b>1902016553</b>	· SPRING	1				
96	<b>1902016554</b>	· POPPET	1				
97	<b>1902018812</b>	· O-RING	1				

**U2h060**



**Engine for TL240 4TNV98T-ZNTBL  
CYLINDER HEAD & BONNET**

Item	Part No	Description	Qty
72	Y129928-03080	HOSE CMP, BREATHER	1
74	Y129410-03990	· CLAMP 22	2
76	Y129150-03100	RETAINER	1
77	Y129972-03240	MISTSEPARATOR ASSY	1
78	Y129972-03220	· COVER,SEPARATOR	1
79	Y129972-03230	· MISTSEPARATOR	1
80	Y123901-03240	· WOOL, STEAL	3
81	Y26116-050102	· BOLT M 5X 10 PLATED	4
82	Y129928-03300	HOSE ASSY,BREAZER	1
84	Y129928-59130	· PROTECTOR, PIPE 19	1
85	Y23000-019000	CLAMP 19	2
86	Y23065-160250	HOSE, 16 X 250	1
87	Y26106-080122	BOLT M 8X 12 PLATED	2
88	Y26106-080142	BOLT 8X 14 PLATED	2

**Engine for TL240 4TNV98T-ZNTBL  
CRANKSHAFT & PISTON**

Item	Part No	Description	Qty
1	Y129908-21100	CRANKSHAFT ASSY	1
3	Y129900-21220	• GEAR, CRANKSHAFT	1
4	Y121850-21290	• PARALLEL PIN	1
5	Y121850-21920	• PARALLEL PIN 10X22	1
6	Y22512-070140	• KEY 7X 14	1
7	Y129916-21610	BOLT, V-PULLEY	1
8	Y129960-21640	WASHER	1
9	Y129916-21680	V-PULLEY, CRANKSHAFT	1
10	Y24341-000530	O-RING 1A S-53.0	1
11	Y121850-21130	BOLT, FLYWHEEL	6
12	Y129949-21560	FLYWHEEL ASSY	1
14	Y129900-21600	• GEAR, RING	1
15	Y129928-22080	PISTON ASSY	4
17	Y129927-22050	• RING SET, PISTON	4
21	Y120130-22301	PIN, PISTON	4
22	Y22252-000300	CIRCLIP 30	8
23	Y129900-23001	ROD ASSY, CONNECTING	4
26	Y129900-23200	• BOLT, ROD	8
27	Y129900-23601	• METAL ASSY, CRANKPIN	4
29	Y129900-23911	BUSH, PISTON PIN	4
30	Y129900-23611	BEARING,PIN U.S=0.25	4
32	Y729928-22900	PISTON W/RING,0.25OS	4
34	Y729927-22950	• RING SET, 0.25OS	4

Engine for TL240 4TNV98T-ZNTBL  
FUEL INJECTION PUMP

Item	Part No	Description	Qty
137	Y26106-080202	BOLT M 8X 20 PLATED	3
138	Y26106-080302	BOLT M 8X 30 PLATED	3

CLICK HERE TO **DOWNLOAD** THE COMPLETE MANUAL

- Thank you very much for reading the preview of the manual.
- You can download the complete manual from: [www.heydownloads.com](http://www.heydownloads.com) by clicking the link below



- Please note: If there is no response to CLICKING the link, please download this PDF first and then click on it.

CLICK HERE TO **DOWNLOAD** THE COMPLETE MANUAL