

# 624K Loader



**JOHN DEERE**

## **PARTS CATALOG**

**624K Loader**

**PC10058 (Jun-10) English**

**Worldwide Construction and Forestry Division**

Litho in U.S.A. (Revised)  
COPYRIGHT © 2010  
DEERE & COMPANY  
Moline, Illinois  
All rights reserved

CLICK HERE TO **DOWNLOAD** THE COMPLETE MANUAL

- Thank you very much for reading the preview of the manual.
- You can download the complete manual from: [www.heydownloads.com](http://www.heydownloads.com) by clicking the link below



- Please note: If there is no response to CLICKING the link, please download this PDF first and then click on it.

CLICK HERE TO **DOWNLOAD** THE COMPLETE MANUAL

---

**Table of Contents - Continued**

1741 Engine Or Main Frame .....	518
1743 Hinges, Yokes & Gudgeons .....	520
1746 Frame Bottom Guards .....	522
1749 Chassis Weights .....	526
<b>18 Operator's Station</b>	
1807 Special Noise Control Items .....	528
1810 Operator Enclosure .....	530
1811 ROPS, FOPS, OPS, Or Body Frame .....	538
1812 Platform .....	552
1813 Body Sides, Doors, Shields And Glazing .....	556
1814 Windshield & Wipers .....	558
1816 Instrument & Control Mounting Structure .....	562
1821 Seat And Seat Belts .....	574
1822 Steps & Handholds .....	584
1831 Heater, Hoses & Controls .....	590
1832 Air Cond System Compressor & Drive .....	598
1833 Condenser, Evaporator & Lines .....	600
1835 Pressurizer .....	610
<b>19 Sheet Metal &amp; Styling</b>	
1911 Hood & Hood Supports .....	612
1912 Engine Sideshields .....	614
1913 Miscellaneous Shields .....	616
1927 Fenders .....	624
<b>20 Safety, Convenience &amp; Miscellaneous</b>	
2001 Radio .....	634
2002 Mirror .....	642
2003 Fire Extinguisher .....	648
2004 Warning Devices Including Horn & Reverse Alarm .....	650
2007 Sun Visor .....	658
2008 Reflectors & SMV Sign .....	660
2013 Anti-Theft .....	662
<b>21 Vehicle Main Hydraulic System</b>	
2161 Hydraulic Pumps & Drives .....	664
2162 Hydraulic Selective Control & Load Holding Valves .....	668
2163 Hydraulic Lines & Hoses .....	674
2164 Hydraulic Reservoir, Filter & Cooler .....	676
<b>26 Global Vehicle Communication</b>	
2601 Communication Controller .....	680
<b>31 Loader</b>	
3101 Cutting Edge .....	682
3102 Bucket (Including Teeth) .....	686
3103 Forks .....	700
3104 Attachment Coupler .....	706
3141 Main Frame .....	726
3143 Moveable Frame .....	734
3145 Bucket Loader Linkage .....	748
3162 Control & Load Holding Valves .....	760
3163 Lines, Hoses & Fittings .....	858
3165 Hydraulic Cylinders .....	898
3166A Automatic Control Function .....	918

## Alphabetical Index - Continued

Page	Page		
Hose, Heater .....	596	Hydraulic Pressure Transducer Connector, Engine Frame Harness..	484
Hose, Park Brake Breather.....	412	Hydraulic Pump .....	664
Hose, Radiator (Engine 6068HDW79) .....	320	Hydraulic Pump Manifold.....	668
Hose, Radiator (Engine 6068HDW83) .....	322	Hydraulic Pump Manifold Guard.....	672
Hose, Rear Differential Lock.....	48	Hydraulic Reservoir, High Altitude Pressurization Kit.....	678
HOSE, ROCKER ARM COVER VENT(2917)(HDW79) .....	160	Hydraulic Temperature Sensor Connector, Engine Frame Harness..	484
Hose, Secondary Steering.....	376		
Hose, Secondary Steering Kit .....	380	I	
Hose, Secondary Steering (Joystick) .....	378		
Hose, Steering Cylinder.....	396		
Hose, Window Washer Reservoir.....	560	IDLER GEAR (3614) HDW74.....	166
HOUSING, FLYWHEEL (1405) .....	228	Idler Pulley, 100 A Alternator (w/o A/C) .....	450
HOUSING, FLYWHEEL (1405) (HDW79) .....	146	Idler Pulley, 100 A Alternator (w/ A/C) .....	452
Housing, HVAC Module.....	608	Idler Pulley, 80 A Alternator (w/o A/C) .....	446
HOUSING, OIL PUMP (5024) .....	268	Idler Pulley, 80 A Alternator (w/ A/C) .....	448
HOUSING, OIL PUMP (5024) (HDW79) .....	186	Ignition Key .....	418
HOUSING, STANDARD INPUT NON- OSC .....	70	INJECTION NOZZLE, WIRING HARNESS (169Z) (HDW79) .....	148
HOUSING, STD INPUT.....	68	Inlet Valve Section with Relief Valve.....	774
HOUSING, THERMOSTAT (3917) (HDW79) .....	170	INLET, WATER PUMP (5728) .....	274
HOUSING, THERMOSTAT (3933) .....	252	INLET, WATER PUMP (5728) (HDW79) .....	192
Housing, Torque Converter.....	98	Input Gear, Transmission .....	100
Housing, Transmission .....	102	INPUT HOUSING, STANDARD NON- OSC .....	70
Hub, Engine Fan.....	334	Input Shaft, Torque Converter .....	98
HVAC Control Console .....	590	Input Shaft, Transmission .....	100
HVAC Ducts.....	594	Input Speed Sensor Connector, Transmission Harness.....	488
HVAC Louvers.....	590	INPUT YOKE WITH SLINGER.....	58, 60
HVAC Module.....	606	INTAKE MANIFOLD AND GASKET (1797) .....	232
HVAC Module Components.....	608	Intake System, Air (Engine 6068HDW79) .....	350
HVAC Module Wiring Harness .....	504	Intake System, Air (Engine 6068HDW83) .....	352
HVAC Module (Heater Only) .....	604	INTAKE VALVE (5120) (HDW79) .....	188
HVAC Pre-Cleaner .....	610	INTAKE VALVE (5128) .....	270
Hydraulic Fan Drive Pump (Axle Cooling System Kit) (S.N. -626437).....	328	INTAKE, AIR (17BL) (HDW79) .....	150
Hydraulic Fan Drive Pump (Axle Cooling System Kit) (S.N. 626438- ).....	330	INTAKE, OIL PUMP (1946) .....	234
Hydraulic Fan Drive Pump (Axle Cooling System Kit) (S.N. 626438- ).....	330	INTAKE, OIL PUMP (1946) (HDW74) .....	152
Hydraulic Fan Drive Pump (Axle Cooling System w/ Secondary Steering) (S.N. 626438- ) .....	332	Interior Covers, Cab .....	562
Hydraulic Fan Drive Pump (Axle Cooling System) (S.N. -626437) ..	324	Interior Covers, Canopy.....	564
Hydraulic Fan Drive Pump (Axle Cooling System) (S.N. 626438- ) ..	326	In-Line Fuel Filter.....	370
Hydraulic Hoses, Axle Cooling System (Axle Cooling System Kit) (S.N. -626437) .....	328	In-Line Fuel Filter (Severe Duty Fuel Filter Kit) .....	374
Hydraulic Hoses, Axle Cooling System (Axle Cooling System Kit) (S.N. 626438- ) .....	330	In-Line Fuel Filter (Severe Duty Fuel System) .....	372
Hydraulic Hoses, Axle Cooling System (S.N. -626437).....	324	Isolators, Cab Noise Reduction.....	528
Hydraulic Hoses, Axle Cooling System (S.N. 626438- ).....	326		
Hydraulic Hoses, Electric Fifth Function.....	800	J	
Hydraulic Hoses, (Axle Cooling System w/ Secondary Steering) (S.N. 626438- ) .....	332		
Hydraulic Lines, Coupler Cable Reinforced (High Lift Z-Bar) .....	888	JDLink™ Ultimate .....	680
Hydraulic Lines, Coupler Cable Reinforced (Z-Bar) (Powerllel™) .....	886	Joystick Armrest, RH .....	568
Hydraulic Lines, Coupler Third Function (High Lift Z-Bar) .....	880	Joystick Controller, Auxiliary.....	836
Hydraulic Lines, Coupler Third Function (Powerllel™) .....	882	Joystick Handle (with FNR) Conversion Kit .....	824
Hydraulic Lines, Coupler Third Function (Tool Carrier) .....	884	Joystick Pilot Controller Components .....	832
Hydraulic Lines, Coupler Third Function (Z-Bar) .....	878	Joystick Pilot Controller (without FNR) .....	792
Hydraulic Lines, Hi-Vis Coupler Cable Reinforced (High Lift Z-Bar) ..	892	Joystick Pilot Controller (without FNR) and Auxiliary Lever .....	794
Hydraulic Lines, Hi-Vis Coupler Cable Reinforced (Powerllel™) .....	894	Joystick Pilot Controller (with FNR) .....	796
Hydraulic Lines, Hi-Vis Coupler Cable Reinforced (Z-Bar) .....	890	Joystick Pilot Controller (with FNR) and Auxiliary Lever .....	798
Hydraulic Lines, Hi-Vis Coupler Pin Disconnect (Tool Carrier) .....	896	Joystick Steering .....	390
Hydraulic Lines, Joystick (w/o FNR) Pilot Controller .....	792	Joystick Steering Deluxe Seat .....	580
Hydraulic Lines, Joystick (w/o FNR) Pilot Controller and Auxiliary Lever .....	794	Joystick Steering Joystick Handle .....	404
Hydraulic Lines, Joystick (w/ FNR) Pilot Controller .....	796	Joystick Steering Kit .....	392
Hydraulic Lines, Joystick (w/ FNR) Pilot Controller and Auxiliary Lever .....	798	Joystick Steering Left Armrest.....	572
Hydraulic Lines, Main .....	674	Joystick Steering Valve.....	394
Hydraulic Lines, Pin Disconnect Valve .....	848	Joystick Steering Wiring Harness.....	402
Hydraulic Lines, Pin Disconnect (Powerllel™) .....	852	Joystick To Joystick with Auxiliary Lever Conversion Kit (Powerllel™).....	820
Hydraulic Lines, Pin Disconnect (Tool Carrier) .....	854	Joystick To Joystick with Auxiliary Lever Conversion Kit (Z-Bar) .....	818
Hydraulic Lines, Pin Disconnect (Z-Bar).....	850	Joystick To Two Lever Controller Conversion Kit .....	816
Hydraulic Lines, Ride Control .....	844	Joystick with Auxiliary Lever to Three Lever Controller Conversion Kit .....	822
Hydraulic Lines, Ride Control (Powerllel™) .....	838	Jumper Harness, Wiper Motor.....	510
Hydraulic Lines, Ride Control (Tool Carrier) .....	842		
Hydraulic Lines, Ride Control (Z-Bar) .....	840	K	
Hydraulic Lines, 2-Function .....	872		
Hydraulic Lines, 2-Lever Pilot Controller .....	786	Key, Ignition .....	418
Hydraulic Lines, 3-Function .....	874	Kickdown Switch, 2-Lever Pilot Controller.....	826
Hydraulic Lines, 3-Lever Pilot Controller .....	788	KIT ENGINE GASKET 9901.....	298
Hydraulic Lines, 4-Function .....	876	Kit, Air Pre-Cleaner.....	354
Hydraulic Lines, 4-Lever Pilot Controller .....	790	Kit, AM/FM/WB Radio .....	636
Hydraulic Oil Cooler.....	318	Kit, AM/FM/WB Radio w/ CD Player.....	640
Hydraulic Oil Reservoir.....	676	Kit, Auxiliary Cutting Edge (2690 mm).....	682
Hydraulic Oil Sampling Fitting .....	434	Kit, Auxiliary Dual Lever Controller Detent .....	830
Hydraulic Pressure Switch Connector, Engine Frame Harness .....	484	Kit, Auxiliary Single Lever Controller Detent.....	828
		Kit, Axle Cooling System (S.N. -626437).....	328
		Kit, Axle Cooling System (S.N. 626438- ).....	330
		Kit, Beacon Light Bracket .....	468

## Alphabetical Index - Continued

	<i>Page</i>	<i>Page</i>
6275 ALTERNATOR BRACKETS.....	276	
6275 (ALTERNATOR BRACKETS).....	194	
6284 (ALTERNATOR BRACKETS).....	195	
6389 (FUEL LINES).....	196	
65TE (TURBOCHARGER).....	198	
6698 TEMPERATURE SWITCH, WITHOUT.....	277	
6698 (TEMPERATURE SWITCH).....	200	
6721 (SENSORS).....	202	
6744 SENSORS.....	278	
80 Amp Alternator (without A/C).....	446	
80 Amp Alternator (with A/C).....	448	
8169 (PRIMARY FUEL FILTER).....	204	
8484 ENGINE WIRING HARNESS.....	280	
8491 (WIRING HARNESS ACCESSORIES).....	206	
8718 BELT TENSIONER.....	281	
8718 (BELT TENSIONER).....	207	
8842 OIL FILTER.....	282	
8842 (OIL FILTER).....	208	
8903 (EXHAUST GAS RECIRCULATION (EGR).....	210	
9801 LIFT STRAPS.....	283	
9801 (LIFT STRAPS).....	212	
9901 AIR COMPRESSOR KIT MIDLAND.....	303	
9901 BEARING KIT.....	286	
9901 CONNECTING ROD BEARING KIT.....	285	
9901 CONNECTING ROD, BEARINGS.....	284	
9901 CONTROL VALVE.....	301	
9901 CYLINDER LINER PACKING.....	290	
9901 EGR VALVE GASKET KIT.....	300	
9901 ENGINE GASKET KIT.....	298	
9901 ENGINE GASKET SET, OVERHAUL.....	296	
9901 ENGINE OVERHAUL KIT.....	308	
9901 INJECTION NOZZLE.....	306	
9901 MAIN BEARING.....	288	
9901 MAIN BEARING KIT.....	287	
9901 PISTON LINER KIT.....	294	
9901 PISTON RING KIT.....	304	
9901 REAR OIL SEAL.....	291	
9901 REPLACEMENT ENGINE.....	310	
9901 STARTER RELAY.....	302, 305	
9901 THRUST BEARING.....	289	
9901 WATER PUMP REPAIR KIT.....	292	
9901 (REPLACEMENT ENGINE).....	216	
9901 -(COMPLETE BLOCK ASSEMBLY).....	214	

**02 Axles, Differentials & Suspension Systems**  
**0201 Drive Axle Hsg & Support (Inc. Final Drives)**

Key	Part No.	Part Name	Qty.	Axle Serial No.	Remarks
1	15H511	Pipe Bushing	1		1/8"
2	15H84	Coupling	1		1/8"
3	19M7865	Screw	2		M8 X 16
4	AT207023	Hydraulic Hose	1		1/8" X 1250 MM (49-1/4") X 1/8"
5	AT208411	Pressure Relief Valve	1		
6	PG200427	Rear Axle	1		(SUB FOR AT342299)
7	PG200418	Rear Axle Reman	1		
8	N199909	Adapter Fitting	1	625705-	
8	R375R	O-Ring	1	625705-	15.545 X 2.616 MM (0.612" X 0.103")
9	R21612	Bleed Valve	1	625705-	
10	T56112	Elbow Fitting	1		3.175 MM (1/8")
11	T75276	Clamp	2		
12	R100122	Cap	1	625705-	

---

<i>Key</i>	<i>Part No.</i>	<i>Part Name</i>	<i>Qty.</i>	<i>Serial No.</i>	<i>Remarks</i>
1	51M7042	O-Ring	1		13.300 X 2.200 MM
2	RE43637	Actuator	1		
3	RE46534	Switch	1		

---

---

<i>Key</i>	<i>Part No.</i>	<i>Part Name</i>	<i>Qty.</i>	<i>Axle Serial No.</i>	<i>Remarks</i>
1	YZ120813	Universal Joint Yoke	1		

---

Key	Part No.	Part Name	Qty.	Axle Serial No.	Remarks
1	JD8255	Bearing Cup	1		
2	JD9078	Bearing Cone	1		
3	RE58664	Fitting	1		
	F3171R	O-Ring	1		
	R27175	Drain Plug	1		
4	R135543	Washer	15		
5	R26448	O-Ring	2		
6	R27218	Fitting Plug	2		
7	R35365	Shim	2		
8	R35366	Shim	2		
9	R35367	Shim	1		
10	YZ120167	Washer	1		
11	R48776	Nut	1		
12	R51196	Shim	1		
13	R51197	Shim	1		
14	R51198	Shim	1		
15	R51199	Shim	1		
16	R56308	Washer	1		
17	11M7032	Cotter Pin	1		5 X 50 MM
18	19M7409	Cap Screw	15		M16 X 50
19	R33138	Fitting	2		
20	YZ121724	Seal	2		(SUB FOR YZ120685 AND YZ120513)
21	JD7759	Lubrication Fitting	2		
22	R375R	O-Ring	2		
23	A4540R	O-Ring	1		
24	YZ121055	Cover	1		
25	RE49486	Tapered Roller Bearing	1		

Key	Part No.	Part Name	Qty.	Axle Serial No.	Remarks
1	YZ121239	Housing	1		
2	YZ120954	Housing	1		
3	YZ121134	Bevel Gear	1		(SUB FOR YZ120386)
4	YZ121133	Bevel Gear	1		(SUB FOR R59289)
5	R93623	Thrust Washer	2		
6	R59460	Thrust Washer	4		
7	34M7040	Spring Pin	1		6 X 30 MM
8	R48787	Cap Screw	18		
9	R70112	Thrust Washer	4		
10	R70113	Thrust Washer	4		
11	R132827	Pinion Shaft	1		
12	R132828	Pinion Shaft	2		
13	W30317	Spring Pin	3		
14	R132836	Hub	1		
15	YZ121230	Cover	1		
16	YZ120964	Clutch Disk	4		
17	YZ121110	Clutch Plate	4		
18	YZ120902	Compression Spring	4		
19	YZ121199	Actuator	1		
20	YZ121090	Seal	1		
21	YZ120968	Seal	1		
22	YZ120970	Needle Bearing	1		
23	YZ120971	Thrust Washer	1		
24	YZ121228	Spacer	1		
25	YZ120961	Bearing Housing W/O Bearing	1		
26	R136314	O-Ring	1		
27	JD8259	Bearing Cup	1		
28	JD8954	Bearing Cone	1		
29	YZ120960	Bearing Housing W/O Bearing	1		
30	YZ121016	Lock Plate	2		
31	R88246	Cap Screw	4		
32	19M7785	Screw	12		M10 X 25
33	19M7838	Screw	16		M12 X 130
34	R85226	Washer	18		
35	YZ121227	Piston	1		
36	YZ121260	Tapered Roller Bearing	1		
37	R134726	Pinion	4		

Key	Part No.	Part Name	Qty.	Axle Serial No.	Remarks
1	R109083	Washer	3		
2	R112079	Thrust Washer	6		
3	R116810	Planet Pinion Carrier	1		
4	R119270	Washer	1		
5	R33029	Snap Ring	1		
6	R52389	Shim	1		
7	R97998	Pinion Shaft	3		
8	R135543	Washer	40		
9	YZ121119	Lock Plate	2		
10	R54380	Dowel Pin	2		
11	R82175	Cap Screw	2		
12	19M8620	Cap Screw	40		M16 X 110
13	R109082	Needle Roller	144		
14	YZ121125	Planet Pinion	3		
15	YZ121129	Pinion Shaft	2		
16	YZ120647	Gear	2		

<i>Key</i>	<i>Part No.</i>	<i>Part Name</i>	<i>Qty.</i>	<i>Transmission Serial No.</i>	<i>Remarks</i>
1	T171114	Pinion Shaft	1		
2	T171126	Bearing	2		Important - High Tolerance Bearing Required in this Location. Use ONLY John Deere Parts Sourced Bearings.
3	T171178	Snap Ring	1		
4	T173807	Shaft	1		
5	T173808	Gear	1		
6	T173809	Snap Ring	1		
7	T181535	Piston Ring	2		
8	T242441	Shaft	1		

<i>Key</i>	<i>Part No.</i>	<i>Part Name</i>	<i>Qty.</i>	<i>Transmission Serial No.</i>	<i>Remarks</i>
3	19M7964	Cap Screw	5		M8 X 12
14	T174234	O-Ring	6		
15	T174389	Pipe	2		
17	T181455	Cap Screw	2		
18	T197462	Oil Tube	1		
19	T197463	Oil Tube	1		
24	T242448	Tube	1		

---

<i>Key</i>	<i>Part No.</i>	<i>Part Name</i>	<i>Qty.</i>	<i>Transmission Serial No.</i>	<i>Remarks</i>
1	T181535	Piston Ring	1		
2	T175292	Shaft	1		
3	T171140	Ball Bearing	1		
4	40M1872	Snap Ring	1		
5	T174529	O-Ring	1		
6	T174405	Plate	1		
7	T174407	Cap Screw	4		

---



Key	Part No.	Part Name	Qty.	Transmission Serial No.	Remarks
1	T171153	Stud	1		
2	T172104	Disk	2		
3	T172115	Piston Ring	2		
4	T172129	Thrust Bearing	2		
5	T172130	Thrust Washer	2		
6	T181873	Snap Ring	AR		2.4 mm
	T181874	Snap Ring	AR		2.7 mm
	T181875	Snap Ring	AR		3.0 mm
	T181876	Snap Ring	AR		3.3 mm
	T172247	Snap Ring	AR		3.6 mm
	T172251	Snap Ring	AR		4.2 mm
8	T173636	Disk With Outer Spline	1		
9	T173637	Disk With Outer Spline	7		
10	T173638	Disk With Inner Spline	7		
11	T173639	Solid Shim	1		
12	T173806	Idler	1		
13	T173839	Disk Spring	7		
14	T173847	Bearing	1		Important - High Tolerance Bearing Required in this Location. Use ONLY John Deere Parts Sourced Bearings.
15	T173849	Bearing	1		Important - High Tolerance Bearing Required in this Location. Use ONLY John Deere Parts Sourced Bearings.
16	T173853	Piston	1		
17	T173858	Shaft	1		
18	T173958	O-Ring	1		
19	T173960	O-Ring	1		
20	T179594	Needle Bearing	1		
25	T242449	Snap Ring	1		
26	T242453	Clutch	1		

8842-	208
8903-	210
9801-	212
9901A-	214
9901B-	216

Sectional Pictorial Index  
 Index d'illustrations par sections.  
 Иллюстрированный указатель секции  
 Índice de ilustraciones por secciones

RGP12698 A.1

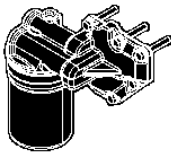
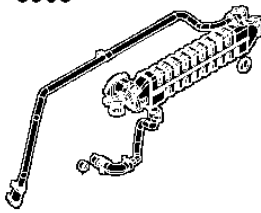
6068HDW79

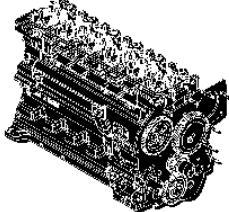
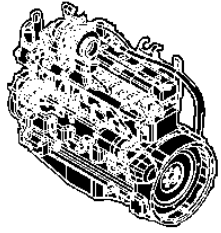
<p>8842</p> 	<p>8903</p> 	<p>9801</p> 	<p>9901A</p> 
<p>9901B</p> 			

RGP12698

---

<i>Key</i>	<i>Part No.</i>	<i>Part Name</i>	<i>Qty.</i>	<i>Engine Serial No.</i>	<i>Remarks</i>
1	R500394	Screw	2		
2	R521060	Air Flow Tube	1		
3	R521061	Gasket	1		
4	R521083	Sleeve	1		
5	R515030	Gasket	1		
6	R519308	Cover	1		
7	19M7785	Screw	8		M10 X 25
8	R522106	Screw	4		

---

---

<i>Key</i>	<i>Part No.</i>	<i>Part Name</i>	<i>Qty.</i>	<i>Engine Serial No.</i>	<i>Remarks</i>
1	TY22505	Hose	1		CUT TO LENGTH
2	R120467	Elbow Fitting	1		
3	R72328	O-Ring	1		

---

Key	Part No.	Part Name	Qty.	Engine Serial No.	Remarks
1	R522776	Housing	1		
2	19M7786	Screw	1		M10 X 30
3	RE46684	Fitting Plug	4		M14 X 1.5
4	51M7041	O-Ring	1		11.300 X 2.200 MM
5	19M7810	Screw	2		M10 X 80
6	R123226	Gasket	2		
7	R519517	Tube	1		
8	R128415	Clamp	2		
9	R519025	Tube	1		
10	R505479	Gasket	1		
11	R63185	O-Ring	4		
12	RE516026	Tube	1		
13	R519737	Manifold	1		
14	R505480	Gasket	2		
15	19M8528	Screw	1		M10 X 55
16	19M7785	Screw	3		M10 X 25
17	RE523250	Manifold	1		
18	R504754	Manifold	1		
19	RE57190	Seal	1		
20	AT323961	Adapter Fitting	1		M12 X 1.5
21	51M7040	O-Ring	1		9.300 X 2.200 MM



5497 (TURBO AIR INLET BRACKET)  
5497 (ARRIVEE D'AIR DU TURBOCOMPRESSEUR, DE SUPPORT)  
5497 (КРОНШТЕЙН ВОЗДУХОЗАБОРНИКА ТУРБОАГНЕТАТЕЛЯ)  
5497 (ENTRADA DE AIRE DEL TURBOCOMPRESOR, DE SOPORTES)

RE529875PCDB01 A.1

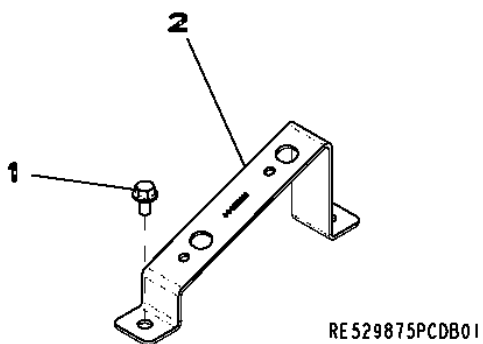

Key	Part No.	Part Name	Qty.	Engine Serial No.	Remarks
1	19M7774	Screw	2		M6 X 12
2	R521503	Bracket	1		













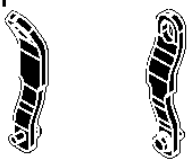

Key	Part No.	Part Name	Qty.	Engine Serial No.	Remarks
1	19M7865	Screw	1		M8 X 16
2	RE538045	Tube	1		
3	R519487	Gasket	3		
4	R520672	Cap Screw	2		
5	R518543	O-Ring	2		
6	RE535729	Heat Exchanger	1		
7	R518859	Bushing	1		
8	19M7798	Screw	1		M8 X 40
9	19M7867	Screw	5		M8 X 25
10	RE523553	Tube	1		
11	19M7864	Screw	1		M8 X 12
12	R519482	Clamp	1		
13	T27523	Clamp	2		
14	T20280	Washer	1		
15	19M7866	Screw	2		M8 X 20
16	19M8627	Screw	2		M6 X 20
17	24M7088	Washer	2		6.600 X 12 X 1.600 MM
18	RE537143	Exhaust Gas Recycling Valve	1		
19	R519989	O-Ring	2		
20	R519398	Gasket	1		
21	RE523554	Tube	1		
22	14M7298	Flange Nut	1		M8
23	RE523617	Bracket	1		
24	19M7868	Screw	2		M8 X 30
25	RE65978	Clamp	2		
26	R524438	Radiator Hose	1		
27	RE523483	Fitting	1		
28	51M7045	O-Ring	1		19.300 X 2.200 MM

Sectional Pictorial Index  
 Index d'illustrations par sections.  
 Иллюстрированный указатель секции  
 Índice de ilustraciones por secciones

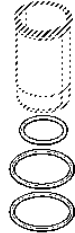
RGP13529 A.2

6068HDW83

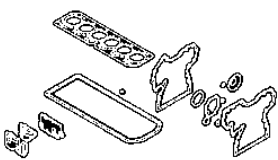
9801-	283
9901A-	284
9901B-	285
9901C-	286
9901D-	287
9901E-	288
9901F-	289
9901G-	290
9901H-	291
9901I-	292
9901J-	294
9901K-	296
9901L-	298
9901M-	300
9901N-	301
9901O-	302
9901P-	303
9901Q-	304
9901R-	305
9901S-	306
9901T-	
9901U-	308

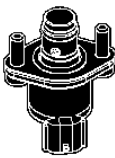
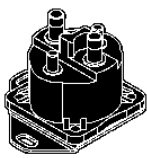
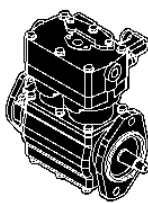
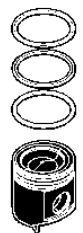
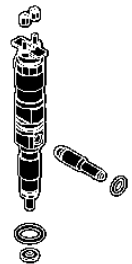
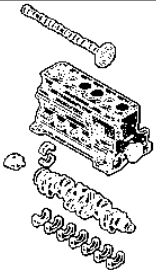
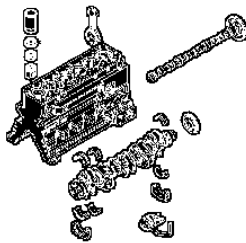
<p>9801</p> 	<p>9901A</p> 	<p>9901B</p> 	<p>9901C</p> 
<p>9901D</p> 	<p>9901E</p> 	<p>9901F</p> 	<p>9901G</p> 
<p>9901H</p> 	<p>9901I</p> 	<p>9901J</p> 	<p>9901K, 9901L</p> 
<p>9901M</p> 	<p>9901N</p> 	<p>9901O, 9901R</p> 	<p>9901P</p> 
<p>9901Q</p> 	<p>9901S</p> 	<p>9901T</p> 	<p>9901U</p> 

RGP13529

Key	Part No.	Part Name	Qty.	Engine Serial No.	HDW83	Remarks
1	R134920	Nut	12			
2	RE509093	Wiring Harness	1			
3	RE534168	Fuel Line	2			
4	RE534167	Fuel Line	2			
5	RE534166	Fuel Line	2			
6	R521159	Stud	3			
7	RE533508	Fuel Injection Pump	1			
8	SE501917	Fuel Injection Pump Reman	1			(REMAN FOR RE533508)
	RE534733	Control Valve	1			
9	RE524528	Kit	1			
10	R524234	O-Ring	1			
11	RE516336	Fuel Temperature Sensor	1			
12	R516125	O-Ring	1			
13	14M7298	Flange Nut	2			M8
14	R525970	Adapter	1			
15	R55453	O-Ring	1			
16	R526013	Helical Gear	1			
17	R91360	Nut	1			
18	R116031	O-Ring	1			
19	51M7044	O-Ring	1			17.300 X 2.200 MM
20	RE517370	Fitting	1			
21	RE534333	Cap Screw	1			
22	19M7868	Screw	2			M8 X 30
23	19M8024	Screw	1			M8 X 30
24	RE534188	Fuel Line	1			
25	RE534189	Fuel Line	1			
26	RE520930	Sensor	1			
27	RE516335	Pressure Relief Valve	1			
28	RE515636	Restrictor	6			
29	R525997	Bracket	1			
30	19M7785	Screw	2			M10 X 25
31	RE520928	Rail	1			
32	R505452	O-Ring	6			
33	R518345	Clamp	6			
34	RE534111	Injection Nozzle	6			(MARKED RE533505 ) (INCLUDES R134920, R65397, R505452, RE522594 AND R515535)
	SE501933	Injection Nozzle Reman	6			(REMAN FOR RE534111)
35	R504781	Cap Screw	6			
36	RE522594	Tube	6			
37	R65397	O-Ring	6			
38	R515044	Fitting	6			(ALSO ORDER R65397)
39	19M7775	Screw	2			M6 X 16





Key	Part No.	Part Name	Qty.	Engine Serial No.	Remarks
1	R133303	Shaft Key	1		
2	19M8999	Screw	2		M8 X 25
3	R132518	Plate	1		
4	RE528950	Camshaft	1		
5	15H584	Pipe Plug	1		1/2"
6	R131182	Orifice	6		
7	T18891	Plug	2		
8	R48685	Dowel Pin	4		
9	RE508185	Fitting	2		
10	U13639	O-Ring	1		
11	15H695	Pipe Plug	1		3/8"
12	R97185	O-Ring	1		
13	T23474	Cap Screw	14		
14	T20168	Washer	14		
15	R26650	Dowel Pin	2		
16	RE505501	Bleed Valve	1		
17	R131425	Compression Spring	1		
18	R119874	Bushing	1		
19	R116466	Plug	1		
20	RE71255	Pipe Plug	1		
21	RE507807	Pipe Plug	1		
22	RE63674	Valve	1		
23	D2361R	Ball	1		

Key	Part No.	Part Name	Qty.	Engine Serial No.	HDW83	Remarks
1	RE521639	Cylinder Head	1			
	SE501583	Cylinder Head Reman	1			
2	RE517435	Sleeve	6			
3	.....	O-Ring	1			(ORDER RE517435)
4	.....	O-Ring	1			(ORDER RE517435)
5	R502371	Retainer	48			
6	R502367	Cap	24			
7	RE531223	Kit	12			
8	RE526519	Seal	24			
9	CD16284	Plug	4			
10	RE71255	Pipe Plug	1			
11	R515033	Valve Seat Insert	12			
12	RE518081	Exhaust Valve	6			
13	R515034	Valve Seat Insert	12			
14	RE531221	Kit	6			
15	R502512	Sleeve	6			
16	R521544	Bushing	2			
17	R520867	O-Ring	7			
18	R502511	Cap Screw	26			
19	R116516	Engine Cylinder Head Gasket	1			

8718 BELT TENSIONER  
8718 TENDEUR DE COURROIE  
8718 BELT TENSIONER  
8718 TENSOR DE CORREA

RE517336PCDD03 A.1

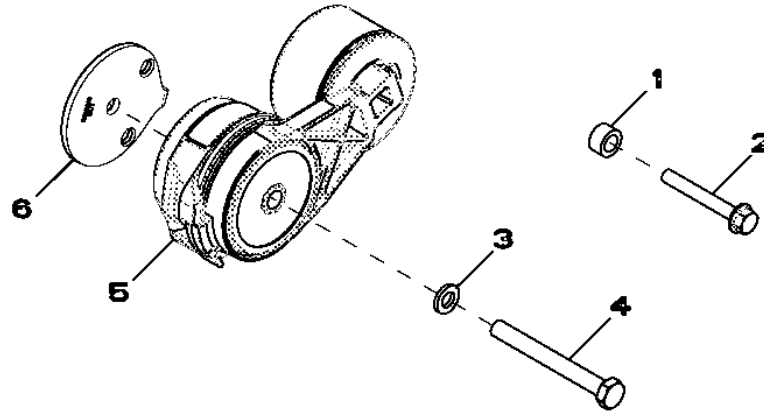

RE 51 7336PCDD03

Key	Part No.	Part Name	Qty.	Engine Serial No.	HDW/83	Remarks
1	28H860	Washer	1			0.423" X 0.675" X 3/8"
2	19M7801	Screw	1			M8 X 60
3	24M7106	Washer	1			10 X 18 X 2.500 MM
4	19M8183	Cap Screw	1			M10 X 90
5	RE518097	Belt Tensioner	1			
6	R518210	Spacer	1			

9901 REAR OIL SEAL  
 9901 JOINT D'ARRET D'HUILE ARRIERE  
 9901 REAR OIL SEAL  
 9901 RETEN DE ACEITE TRASERO

RE44574PCDC02 A.1

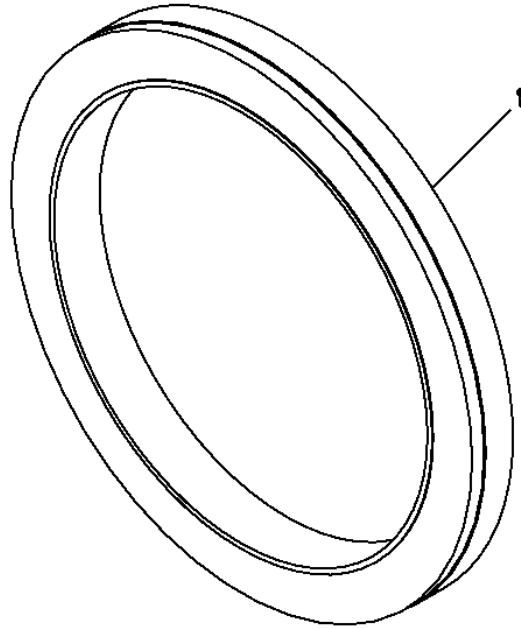

RE44574PCDC02

Key	Part No.	Part Name	Qty.	Engine Serial No.	HDW/83	Remarks
1	RE44574	Seal	1			

9901 CONTROL VALVE  
9901 DISTRIBUTEUR  
9901 CONTROL VALVE  
9901 VALVULA DE CONTROL

RE534109PCDC01 A.1

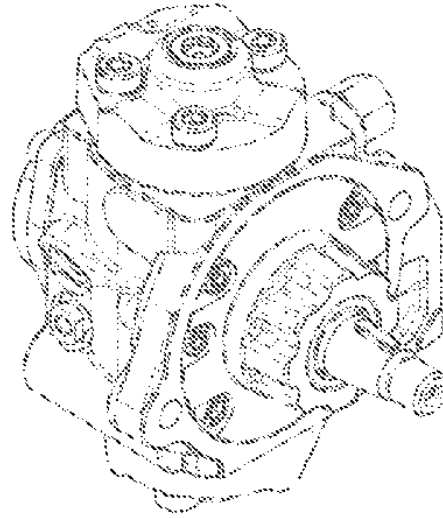
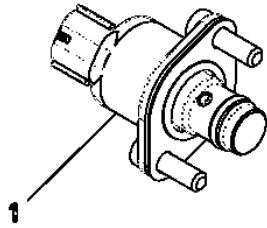

RE534109PCDC01

Key	Part No.	Part Name	Qty.	Engine Serial No.	HDW/83	Remarks
1	RE534109	Control Valve	1			

Key	Part No.	Part Name	Qty.	Engine Serial No.	HDW83	Remarks
1	.....	Diesel Engine	1			(A)

(A) MAY NOT BE AS ILLUSTRATED  
 PEUT NE PAS ETRE ILLUSTRE  
 MAY NOT BE AS ILLUSTRATED  
 PUEDE DIFERIR DE LA ILUSTRACION

Key	Part No.	Part Name	Qty.	Serial No.	Remarks
1	14M7298	Flange Nut	1		M8
2	19M7784	Screw	3		M10 X 20
3	19M7865	Screw	6		M8 X 16
4	19M7866	Screw	7		M8 X 20
5	19M7867	Screw	1		M8 X 25
6	24M7298	Washer	8		8.400 X 25 X 2 MM
7	AA46694	Clamp	1		
8	AH170895	Clamp	9		
9	AR21837	Clamp	1		
10	AR21839	Clamp	2		
11	TY22462	Clamp	5		
12	AT310335	Filler Cap	1		
13	AT322957	Tank	1		
16	T223206	Adapter Fitting	1		(ALSO ORDER U17409) (AT326597 NLA)
18	U17409	O-Ring	1		
19	AT332096	Support	1		
20	AT35831	Drain Valve	1		
21	E69975	Clamp	1		
22	N189220	Tie Band	1		
23	R115350	Grommet	2		
24	RE56098	Clamp	3		
25	T162575	Clamp	1		
26	T181778	Hose	3		
27	.....	Isolator	1		(MAKE FROM T63019) (CTL 3.2 ft.)
28	T212469	Tube	1		
29	T212470	Tube	1		
30	T212471	Radiator Hose	1		
31	T213531	Bracket	1		
32	.....	Bulk Hose	1		(MAKE FROM TY22324) (CTL 2.4 ft.)
33	.....	Bulk Hose	1		(MAKE FROM TY22324) (CTL 3.3 ft.)
34	T218382	Radiator Hose	1		
35	T218394	Radiator Hose	1		
36	.....	Bulk Hose	1		(MAKE FROM TY22324) (CTL 4.4 ft.)
37	.....	Bulk Hose	1		(MAKE FROM T60811) (CTL 9.0 ft.)
38	T254778	Shield	1		(SUB FOR T225859)
39	T238657	Hose	1		
40	T27550	Clip	1		
41	T47338	Grommet	1		
42	T74416	Clamp	2		
43	T76252	Clamp	1		

Key	Part No.	Part Name	Qty.	Serial No.	Remarks
1	<b>AT371785</b>	<b>Filter Kit</b>	<b>1</b>		<b>Axle Cooling System, (WHOLE GOODS)</b>
2	AT330592	Oil Cooler	1		
3	AT330678	Bracket	1		(UPPER)
4	24M7296	Washer	8		10.500 X 30 X 2.500 MM
5	19M7786	Screw	4		M10 X 30
6	AT330606	Bracket	1		(LOWER)
7	19M7835	Screw	4		M10 X 35
8	.....	Oil Pump	1		Furnish Components
	AT318789	Seal Kit	1		
	AT324290	Oil Pump	1		Fan Drive
	AT346051	Oil Pump	1		Axle Oil Circulation
9	T213828	Plate	1		
10	R135543	Washer	2		
11	19M3212	Cap Screw	2		M16 X 55
12	38H1291	Tee Fitting	1		
13	T77613	O-Ring	3		
14	24H1391	Washer	2		25/32" X 1-5/16" X 0.060"
15	T81029	Nut	2		
16	T234564	Plate	1		
17	R47172	Washer	2		
18	19M7361	Cap Screw	2		M12 X 50
19	38H1005	Elbow Fitting	1		
20	R26375	O-Ring	1		
21	T77857	O-Ring	1		
22	62H1012	Adapter Fitting	1		
23	R26375	O-Ring	1		
24	38H1004	Elbow Fitting	1		
25	R26448	O-Ring	1		
26	T77613	O-Ring	1		
27	62H1011	Adapter Fitting	1		
28	R26448	O-Ring	1		
29	AT220925	Oil Filter	1	628932	
	AT386450	Oil Filter	1	628933-	
30	U12547	O-Ring	1		
31	38H1094	Elbow Fitting	1		
32	T77613	O-Ring	1		
33	38H1031	Tee Fitting	1		
34	T77857	O-Ring	2		
35	AT312932	Fitting	2		
36	AT335179	Hydraulic Hose - Fabricate	1		
37	AT335179	Hydraulic Hose - Fabricate	1		
38	AT335179	Hydraulic Hose - Fabricate	1		
39	AT335179	Hydraulic Hose - Fabricate	1		
40	AT333062	Hydraulic Hose - Fabricate	1		
41	AT333057	Hydraulic Hose - Fabricate	1		
42	AT332605	Hydraulic Hose - Fabricate	1		
43	AT371083	Hydraulic Hose - Fabricate	1		
44	AT333055	Hydraulic Hose - Fabricate	1		
45	AT334170	Hydraulic Hose - Fabricate	1		
46	R136495	Gasket	3		
47	R116296	Cover	1		
48	19M7866	Screw	3		M8 X 20
49	R136514	Spacer	1		
50	R517353	Filler Neck	1		
51	R504604	Screw	2		
52	T225866	Dipstick Tube	1		
53	AT329269	Dipstick	1		
54	T218003	Label	2		Axle/Gearbox Oil
55	T77857	O-Ring	4		
56	R522690	Gasket	1		
57	T238029	Adjusting Strap	1		
58	AH77869	Clip	1		
59	AT380104	Bracket	1		
60	24M7242	Washer	2		21.400 X 42 X 5 MM
61	19M7950	Cap Screw	2		M20 X 45
62	AT371099	Filter	2		
63	AT367635	Hydraulic Filter	2		
64	19M7785	Screw	8		M10 X 25
65	R70921	Adapter Fitting	4		
66	U12547	O-Ring	4		
67	38H1010	Elbow Fitting	1		
68	T77613	O-Ring	1		
69	AT369202	Hydraulic Hose - Fabricate	1		(FRONT)
70	AT369203	Hydraulic Hose - Fabricate	1		(REAR)
71	AT380666	Hydraulic Hose - Fabricate	1		(FRONT)
72	AT380667	Hydraulic Hose - Fabricate	1		(REAR)
73	R26375	O-Ring	1		

Key	Part No.	Part Name	Qty.	Serial No.	Remarks
1	14M7517	Lock Nut	2		M10
2	19M7791	Bolt	2		M12 X 40
3	19M7812	Screw	2		M10 X 100
4	19M7835	Screw	2		M10 X 35
5	38H1004	Elbow Fitting	1		
6	R26448	O-Ring	1		
7	T77613	O-Ring	1		
8	38H1005	Elbow Fitting	1		
9	R26375	O-Ring	1		
10	T77857	O-Ring	2		
11	38H1006	Elbow Fitting	4		
12	R26906	O-Ring	5		
13	T77932	O-Ring	4		
14	38H1007	Elbow Fitting	1		
15	T77858	O-Ring	1		
16	U12547	O-Ring	1		
17	38H1012	Elbow Fitting	1		
18	38H1049	Elbow Fitting	1		
19	R29936	O-Ring	1		
20	T76938	O-Ring	1		
21	AT316250	Oil Pump	1		
	AT318742	Seal Kit	1		
22	AT225805	Solenoid Valve	1		
23	AT226404	Hydraulic Motor	1		
	AT317353	Seal Kit	1		
24	R522690	Gasket	1		

Key	Part No.	Part Name	Qty.	Serial No.	Remarks
1	14M7400	Lock Nut	4		M10
2	19M7786	Screw	4		M10 X 30
3	24M7296	Washer	4		10.500 X 30 X 2.500 MM
4	AR85327	Clamp	1		
5	AT300489	Clamp	2		
6	AT300487	Filter Element	1		
7	AT314583	Filter Element	1		
8	AT329958	Housing	1		
9	M89679	Ejector	1		(SUB FOR T200280)
10	T223372	Cover	1		
11	AT53439	Hose Clamp	1		
12	R44302	Tie Band	1		
13	RE52703	Hose Clamp	1		
14	RE68255	Sensor	1		
15	T200282	Hose	1		
16	T211510	Hose	1		
17	T219672	Elbow Fitting	1		
18	14M7296	Flange Nut	4		M10
19	19M7785	Screw	4		M10 X 25
20	T198109	Reinforcement	1		

Key	Part No.	Part Name	Qty.	Serial No.	Remarks
1	AT368118	Muffler	1		
2	AT320673	Exhaust Pipe	1		Black
3	19M7786	Screw	4		M10 X 30
4	24M7296	Washer	4		10.500 X 30 X 2.500 MM
5	14M7400	Lock Nut	4		M10
6	AT372744	Bracket	1		
7	19M7788	Screw	1		M12 X 25
8	19M7785	Screw	2		M10 X 25
9	19M7804	Screw	2		M10 X 40
10	19M7835	Screw	2		M10 X 35
11	AT222597	Clamp	1		
12	T201869	U-Bolt	1		
13	24M7240	Washer	1		13 X 25 X 3 MM
14	19M8017	Cap Screw	1		M12 X 20
15	E80242	Lock Nut	2		

**05 Engine Auxiliary System**  
**0560 External Fuel Supply Systems**

Key	Part No.	Part Name	Qty.	Serial No.	Remarks
1	14M7396	Lock Nut	1		M8
2	19M7785	Screw	1		M10 X 25
3	19M7866	Screw	1		M8 X 20
5	T77613	O-Ring	1		9.250 X 1.780 MM (0.364" X 0.070")
7	51M7040	O-Ring	1		9.300 X 2.200 MM
8	38H5008	Adapter Fitting	1		
10	AT223493	Fuel Filter	1		
11	AT227937	Fuel Sender	1		
12	19M7317	Screw	5		M5 X 30
13	24M7027	Washer	5		5.300 X 10 X 1 MM
14	T196733	Gasket	1		
15	AT228627	Hydraulic Hose - Fabricate	1		
16	AR21837	Clamp	1		
17A	.....	Fuel Tank	1		(SUB AT361034) (AT316311 NLA)
17B	AT361034	Fuel Tank	1		
18	AH159448	Link Chain	1		
19	AH162914	Strainer	1		
20	AH165079	Adapter Fitting	1		
21	H172014	Gasket	1		
22	AR21839	Clamp	1		
23	H174831	Anchor	1		
24	R193666	Fitting	1		
25	R194311	Compression Spring	1		
26	RE179976	Check Valve	1		
27	RE194040	Fitting	1		
28	AT346094	Cap	1		
29	T164203	Screw	1		
30	AR21839	Clamp	1		
31	AT323720	Hydraulic Hose - Fabricate	1		13/16" X 635 MM (25") X 17.475"
34	R184863	Hose Clamp	2		
35	R44302	Tie Band	2		
37	RE52504	Breather	1		
41	T13254	Clamp	2		
42	T75197	Clamp	1		
43	T75276	Clamp	1		
44	T242677	Hose Clamp	1		
45	.....	Bulk Hose	1		(MAKE FROM T79477) (CTL 1.75 ft.)
46	.....	Bulk Hose	3		(MAKE FROM T79477) (CTL 2.0 ft.)
47	.....	Bulk Hose	1		(MAKE FROM T79477) (CTL 2.75 ft.)
48	61M5008	Adapter Fitting	1		
49	R237815	Vent	1		
50	R114023	Grommet	1		

Key	Part No.	Part Name	Qty.	Serial No.	Remarks
1	14M7274	Nut	4		M10
2	19M7784	Screw	2		M10 X 20
3	19M7785	Screw	4		M10 X 25
4	19M7866	Screw	3		M8 X 20
5	19M7950	Cap Screw	2		M20 X 45
6	24M7242	Washer	2		21.400 X 42 X 5 MM
7	38H1005	Elbow Fitting	1		
8	R26375	O-Ring	2		16.358 X 2.210 MM (0.644" X 0.087")
9	T77857	O-Ring	3		12.420 X 1.780 MM (0.489" X 0.070")
10	38H1030	Tee Fitting	1		
11	T77613	O-Ring	3		9.250 X 1.780 MM (0.364" X 0.070")
12	38H1052	Elbow Fitting	1		
13	R29936	O-Ring	2		29.743 X 2.946 MM (1.171" X 0.116")
14	T77858	O-Ring	6		18.770 X 1.780 MM (0.739" X 0.070")
15	38H1095	Elbow Fitting	1		
16	38H1161	Adapter Fitting	1		
17	38H1163	Adapter Fitting	3		
18	U12547	O-Ring	3		23.470 X 2.946 MM (0.924" X 0.116")
19	38H1193	Adapter Fitting	1		
20	R26906	O-Ring	1		19.177 X 2.464 MM (0.755" X 0.097")
21	38H1194	Adapter Fitting	1		
22	38H1435	Elbow Fitting	1		
23	R28782	O-Ring	1		
24	AT210155	Wiring Harness	1		Secondary Steering
25	AT335247	Manifold	1		Secondary Steering Valve, Components On Separate Page
26	AT342661	Hydraulic Hose - Fabricate	1		
27	AT342667	Hydraulic Hose - Fabricate	1		
28	AT342672	Hydraulic Hose - Fabricate	1		
29	AT342677	Hydraulic Hose - Fabricate	1		
30	AT361475	Hydraulic Hose - Fabricate	1		
31	AT342687	Hydraulic Hose - Fabricate	1		
32	AT347031	Hydraulic Hose - Fabricate	1		
33	AT355074	Pump	1		
34	AT210093	Solenoid	1		
35	AT210094	Motor	1		
36	AT355075	Steering Metering Pump	1		
37	T146443	Safety Sign	1		Caution - Secondary Steering
38	T173579	Bracket	1		
39	T228639	Plate	1		
40	AT341272	Hydraulic Hose - Fabricate	1		
41	AT210056	Wiring Harness	1		Secondary Steering Switch
50	AT337264	Field Installation Kit	1		(WHOLE GOODS)

Key	Part No.	Part Name	Qty.	Serial No.	Remarks
1	19M7787	Screw	4		M12 X 20
2	19M7865	Screw	4		M8 X 16
3	38H1004	Elbow Fitting	2		
4	R26448	O-Ring	3		11.887 X 1.981 MM (0.468" X 5/64")
5	T77613	O-Ring	5		9.250 X 1.780 MM (0.364" X 0.070")
6	38H1012	Elbow Fitting	1		
7	R26906	O-Ring	5		19.177 X 2.464 MM (0.755" X 0.097")
8	T77857	O-Ring	3		12.420 X 1.780 MM (0.489" X 0.070")
9	38H1025	Tee Fitting	1		
10	T77932	O-Ring	11		15.600 X 1.780 MM (0.614" X 0.070")
11	38H1031	Tee Fitting	1		
12	38H1040	Tee Fitting	2		
13	38H1162	Adapter Fitting	2		
14A	38H1437	Tee Fitting	1	-623742	
14B	38H1052	Elbow Fitting	1	623743-	
15	R29936	O-Ring	1		29.743 X 2.946 MM (1.171" X 0.116")
16	T76938	O-Ring	1		23.520 X 1.780 MM (0.926" X 0.070")
17	T77858	O-Ring	2		18.770 X 1.780 MM (0.739" X 0.070")
18	38H1163	Adapter Fitting	1		(SUB FOR 38H1492, THIS APPLICATION)
19	U12547	O-Ring	1		23.470 X 2.946 MM (0.924" X 0.116")
20	38H1546	Tee Fitting	1		
21	AT336654	Tee Fitting	1		
22	AT336696	Hydraulic Hose - Fabricate	1		
23	AT342850	Hydraulic Hose - Fabricate	1		
24	AT342878	Hydraulic Hose - Fabricate	2		
25	AT347430	Hydraulic Hose - Fabricate	1		(SUB FOR AT349522, THIS APPLICATION)
26	AT351575	Spool Valve	1	-623742	(SUB FOR AT351575)
	AT360792	Valve Stack	1	623743-	
	AT324966	Seal Kit	1		
27	AT355160	Hydraulic Hose - Fabricate	1		
28	AT356336	Hydraulic Hose - Fabricate	1		
29	AT356381	Hydraulic Hose - Fabricate	1		
30	AT356384	Hydraulic Hose - Fabricate	1		
31	AT358897	Hydraulic Hose	1		
32	T226928	Plate	1		

Key	Part No.	Part Name	Qty.	Serial No.	Remarks
1	H162141	Piston	1		
2	RE20342	Seal	1		
3	R81774	Scraper Ring	1		
4	AH148608	Seal	1		
5	AH150453	Seal	1		
6	H155655	Seal	1		
7	H157897	Wear Ring	1		
8	H178765	Snap Ring	1		
9	H179657	Snap Ring	1		
10	H210939	Hydr. Cylinder Rod Guide	1		
11	R81195	Back-Up Ring	1		
12	U12198	O-Ring	1		
13	AH227116	Rod	1		(ALSO ORDER T225516 AND (2) T225565)
14	H170538	Nut	1		
15	.....	Seal	1		
16	.....	Back-Up Ring	1		
17	.....	Seal	1		
18	.....	Back-Up Ring	2		
19	.....	Seal	1		
30	AH227114	Hydraulic Cylinder	1		(ALSO ORDER T225516, T225515, (2) T225564 AND (2) T225565)
32	AH149194	Hydraulic Cylinder Kit	1		Rod Seal Kit
34	AH212089	Hydraulic Cylinder Kit	1		Bore Seal Kit

<i>Key</i>	<i>Part No.</i>	<i>Part Name</i>	<i>Qty.</i>	<i>Serial No.</i>	<i>Remarks</i>
1	19M7807	Screw	2		
2	24M7296	Washer	8		M10 X 60
3	38H1030	Tee Fitting	1		10.500 X 30 X 2.500 MM
4	T77613	O-Ring	6		
5	38H1067	Adapter Fitting	2		
6	R26448	O-Ring	4		
7	AT357295	Isolator	4		
8	AT223768	Hydraulic Hose - Fabricate	1		
9	AT224430	Hydraulic Accumulator	2		
10	AT335801	Hydraulic Hose - Fabricate	2		(SUB FOR AT336179)
11	T168393	Clamp	4		

Key	Part No.	Part Name	Qty.	Serial No.	Remarks
1	JD5822	Label	2		Leaping Deere
2	T146097	Label	1		Warning - Seat Belt
3	T215155	Label	2		Warning - Brake Accumulator
4	T227992	Label	1		Switch Identification
5	T227994	Label	1		ROPS / FOPS Certification
6	T230819	Label	1		Counter Switch
7	T231584	Safety Sign	1		Caution - Engine Start/Stop

---

<i>Key</i>	<i>Part No.</i>	<i>Part Name</i>	<i>Qty.</i>	<i>Serial No.</i>	<i>Remarks</i>
1	14M7277	Nut	4		M20
2	19M8639	Cap Screw	4		M20 X 70
3	24M7242	Washer	8		21.400 X 42 X 5 MM
4	T156995	Plate	2		

---

---

<i>Key</i>	<i>Part No.</i>	<i>Part Name</i>	<i>Qty.</i>	<i>Serial No.</i>	<i>Remarks</i>
1	19M8389	Cap Screw	6		M20 X 280
2	24M7242	Washer	6		21.400 X 42 X 5 MM
3	AR83396	Quick Lock Pin	1		
4	AT324715	Counterweight	1		644 lbs.
5	T215610	Hitch	1		600 lbs.
6	T23914	Pin	1		

---

**16 Vehicle Electrical Systems**  
**1672 Alternator, Regulator & Charging System Wiring**

Key	Part No.	Part Name	Qty.	Serial No.	Remarks
1	14M7298	Flange Nut	2		M8
2	14M7299	Flange Nut	1	625092-	M12
3	14M7303	Flange Nut	1		M6
4	14M7400	Lock Nut	4		M10
5	19M7785	Screw	2	625092-	M10 X 25
6	19M7786	Screw	2	625092-	M10 X 30
7	19M7804	Screw	1		M10 X 40
8	19M7808	Screw	2		M10 X 65
9	19M7811	Screw	1		M10 X 90
10	19M7822	Screw	1	625092-	M12 X 160
11	19M7835	Screw	3		M10 X 35
12	24M7238	Washer	1		8.700 X 17 X 2 MM
13	24M7239	Washer	2		10.700 X 21 X 2.500 MM
14	AT211041	Pulley	1		
15	AT300167	Alternator	1		100 A
	SE501838	Alternator Reman	1		100 A
16	T201538	Pulley	1		
17	AT313536	Bracket	1		
18	R133643	Spacer	1		
19	R502079	Sleeve	1		
20	T186776	V-Belt	1		1620 X 28.480 MM (63.780" X 1.121")
21	T213873	Strap	1		
22	T254126	Bracket	1	625092-	
31	14M7401	Lock Nut	2	-625091	M12
32	19M7786	Screw	3	-625091	M10 X 30
33	19M7813	Screw	1	-625091	M12 X 45
34	19M8122	Cap Screw	1	-625091	M12 X 85
35	T179468	Bracket	1	-625091	

Key	Part No.	Part Name	Qty.	Serial No.	Remarks
1	14M7299	Flange Nut	2		M12
2	14M7396	Lock Nut	2		M8
3	14M7400	Lock Nut	5		M10
4	19M8292	Screw	6		M10 X 50
5	19M7867	Screw	2		M8 X 25
6	24M7240	Washer	2		13 X 25 X 3 MM
7	24M7296	Washer	6		10.500 X 30 X 2.500 MM
8	57M8998	Elec.Connect Locking Device	4		
9	AT210246	Support	2		
10	AT307090	Lamp	2		LED
15	AT324484	Side Light	2		
16	AT135758	Bulb	1		
17	R44302	Tie Band	3		

Key	Part No.	Part Name	Qty.	Serial No.	Remarks
1	14H605	Nut	2		0.164"
2	14M7396	Lock Nut	2		M8
3	24M7298	Washer	2		8.400 X 25 X 2 MM
4	AT202789	Lamp	2		
	AT173354	Bulb	1		
5	AT203137	Wiring Harness	1		
6	AT301914	Bracket	1		
7	R44302	Tie Band	1		
8	R62356	Grommet	1		
<b>10</b>	<b>AT352644</b>	<b>Bracket Kit</b>	<b>1</b>		<b>(WHOLE GOODS)</b>

CLICK HERE TO **DOWNLOAD** THE COMPLETE MANUAL

- Thank you very much for reading the preview of the manual.
- You can download the complete manual from: [www.heydownloads.com](http://www.heydownloads.com) by clicking the link below



- Please note: If there is no response to CLICKING the link, please download this PDF first and then click on it.

CLICK HERE TO **DOWNLOAD** THE COMPLETE MANUAL

Key	Part No.	Part Name	Qty.	Serial No.	Remarks
1	57M9451	Elec. Connector Terminal	2		HORN
2	RE12364	Electrical Connector Assy	4		
	R78060	Elec. Connector Terminal	9		Return-to-Dig, Turn Signal Light, Marker Light
	R78061	Elec. Connector Terminal	3		
	R78063	Elec. Connector Seal	12		
3	R78054	Electrical Connector Assy	2		Drive Light
	R78061	Elec. Connector Terminal	4		Return-to-Dig / Boom Kick-Out Position Sensor
	R78063	Elec. Connector Seal	4		
	R78064	Elec. Connector Cavity Plug	2		
4	57M8021	Electrical Connector Assy	1		Ride Control Boom Solenoid
	.....	Elec. Connector Terminal	2		
	57M8022	Elec.Connect Locking Device	1		
6	57M7667	Electrical Connector Assy	1		To Load Center Harness
	57M7542	Elec. Connector Terminal	3		
	.....	Elec. Connector Terminal	19		
	R78069	Elec. Connector Cavity Plug	9		
7	57M7254	Electrical Connector Assy	3		Pin Disconnect On/Off Solenoid
	R104846	Elec. Connector Terminal	6		
8	57M8998	Elec.Connect Locking Device	1		
9	R78053	Electrical Connector Assy	1		Ride Control
	R78061	Elec. Connector Terminal	2		
	R78063	Elec. Connector Seal	2		
13	57M7796	Elec. Connector Housing	2		Payload Weight
	R104701	Elec. Connector Terminal	6		
17	AT340679	Wiring Harness	1		Loader Frame

Key	Part No.	Part Name	Qty.	Serial No.	Remarks
1	57M8542	Elec. Connector Housing	4		Tail Light, Brake Light, Turn Signal Light
	57M8571	Elec. Connector Terminal	10		
	57M7936	Elec. Connector Seal	10		
2	57M7743	Elec. Connector Cavity Plug	2		Proportional Fan Solenoid
	57M8542	Elec. Connector Housing	2		
	57M7254	Electrical Connector Assy	1		
	R104846	Elec. Connector Terminal	2		
	.....	Elec. Connector Seal	2		
	57M7289	Elec.Connect Locking Device	1		
3	.....	Elec. Connector Terminal	2		Reverse Alarm
4	RE12363	Electrical Connector Assy	1		License Plate Light
	R78060	Elec. Connector Terminal	2		
6	R78063	Elec. Connector Seal	2		To Engine Frame Harness
	57M8008	Electrical Connector Assy	1		
	57M7542	Elec. Connector Terminal	1		
	.....	Elec. Connector Terminal	11		
7	57M8009	Elec.Connect Locking Device	1		Reversing Fan Solenoid
	57M7534	Elec. Connector Housing	1		
	.....	Elec. Connector Terminal	2		
8	57M8022	Elec.Connect Locking Device	1		(NA)
	57M8015	Electrical Connector Assy	2		
	.....	Elec. Connector Terminal	6		
	R78069	Elec. Connector Cavity Plug	2		
18	57M8016	Elec.Connect Locking Device	2		Rear Frame
	AT345426	Wiring Harness	1		

<i>Key</i>	<i>Part No.</i>	<i>Part Name</i>	<i>Qty.</i>	<i>Serial No.</i>	<i>Remarks</i>
1	21M7292	Screw	4		M6 X 16
3	57M8736	Elec. Connector Accessory	1		
4	AT300921	Clamp	1		
5	21M7258	Screw	1		M4 X 8
6	AT339688	Wiring Harness	1		Steering Column, Components On Separate Page
8	AT342497	Cover	1		
9	AT353427	Switch	1		Turn Signal / High Beam
10	M84972	Nut	3		
11	24H1821	Washer	4		9/32" X 47/64" X 1/16"
12	T75276	Clamp	2		
14	57M8998	Elec.Connect Locking Device	1		
15	R44302	Tie Band	2		

Key	Part No.	Part Name	Qty.	Serial No.	Remarks
1	AT323022	Jumper	1		
2	57M7630	Electrical Connector Assy	1		Wiper Motor
3	T138822	Electrical Connector Assy	1		To Cab Harness
	57M7273	Elec. Connector Terminal	4		
	R78059	Elec. Connector Seal	4		Green
4	R78052	Electrical Connector Assy	1		
	57M7273	Elec. Connector Terminal	1		
	R78059	Elec. Connector Seal	1		Green

17 Frame Chassis Or Supporting Structure  
1743 Hinges, Yokes & Gudgeons

---

<i>Key</i>	<i>Part No.</i>	<i>Part Name</i>	<i>Qty.</i>	<i>Serial No.</i>	<i>Remarks</i>
1	19M7788	Screw	4		M12 X 25
2	AT143577	Bumper	2		

---

---

<i>Key</i>	<i>Part No.</i>	<i>Part Name</i>	<i>Qty.</i>	<i>Serial No.</i>	<i>Remarks</i>
1	AT226578	Roof	1		Yellow
	AT227013	Roof	1		Paintable
2	T167659	Washer	4		
3	24H1368	Washer	4		21/32" X 1-5/16" X 0.090"
4	19H2706	Cap Screw	4		5/8" X 2"

---

Key	Part No.	Part Name	Qty.	Serial No.	Remarks
1	19M7774	Screw	4		M6 X 12
2	19M7796	Screw	2		M6 X 30
3	19M7868	Screw	7		M8 X 30
4	21M7247	Screw	2		M6 X 35
5	37M7089	Screw	3		M6 X 12
6	T180408	Plug	1		
7	T196077	Nut	2		
8	T196079	Nut	16		
9	T228142	Plate	1		
10	T230849	Bracket	1		
11	T240371	Cover	1		
12	T241167	Isolator	1		
13	T245321	Cover	1		
14	T66355	Plug	1		
15	19M7867	Screw	8		M8 X 25

---

<i>Key</i>	<i>Part No.</i>	<i>Part Name</i>	<i>Qty.</i>	<i>Serial No.</i>	<i>Remarks</i>
1	AT44188	Rivet	9		
2	T167519	Window	1		
3	T182925	Retainer	3		
4	T182952	Retainer	3		

---

Key	Part No.	Part Name	Qty.	Serial No.	Remarks
1	14M7303	Flange Nut	4		
2	24M7139	Washer	4		M6
3	AT209947	Tank	1		6.400 X 18 X 1.600 MM
4	AT106365	Pump	2		
5	AT173193	Cap	1		
6	R44302	Tie Band	5		
7	T147618	Tank	1		
8	.....	Hydraulic Hose	1		(MAKE FROM TY25139) (CTL 5.5 ft.)
9	.....	Hydraulic Hose	1		(MAKE FROM TY25139) (CTL 10.0 ft.)
10	.....	Bulk Hose	2		(MAKE FROM TY25139) (CTL)

Key	Part No.	Part Name	Qty.	Serial No.	Remarks
1	03M7184	Bolt	2		M8 X 20
2	14M7296	Flange Nut	2		M10
3	14M7400	Lock Nut	2		M10
4	19M7866	Screw	7		M8 X 20
5	21M7292	Screw	6		M6 X 16
6	24M7298	Washer	2		8.400 X 25 X 2 MM
7	AT334948	Lever	2		
8	AT336859	Armrest	1		
9	14M7298	Flange Nut	1		M8
10	19M8456	Cap Screw	1		M8 X 100
11	AT125158	Knob	1		
12	19M7865	Screw	3		M8 X 16
13	AT355380	Roller	4		
14	R52921	Washer	1		
15	24H1821	Washer	6		9/32" X 47/64" X 1/16"
16	T228348	Cover	1		
17	28H3377	Bushing	1		0.423" X 0.675" X 1-3/4"
18	T242388	Bracket	1		
19	AT353951	Arm	1		(INCLUDES 19M7865)
20	AT354030	Armrest Console	1		
21	AT354202	Armrest Console	1		

Key	Part No.	Part Name	Qty.	Serial No.	Remarks
1	19M7774	Screw	4		M6 X 12
2	R77337	Cap Screw	4		M8 X 25
3	AT308199	Seat Belt	1		
4	AT340281	Seat	1		
5	AT341366	Pedestal	1		
6	AT350612	Switch	1		
7	.....	Arm	1		(AT351041 NLA)
8	AT361363	Seat Suspension	1		
10	14M7397	Lock Nut	4		M6
11	19M7786	Screw	4		M10 X 30
12	19M7814	Screw	4		M12 X 50
13	37M7340	Bolt	6		
14	57M8736	Elec. Connector Accessory	1		
15	AT311997	Bracket	1		
16	AT314833	Cover	1		
17	AT331844	Bracket	1		
20	AT209020	Seat Kit	1		
21	AT209021	Spring Kit	1		
22	R72655	Snap Ring	6		
23	T163334	Spring	1		
24	T163335	Spring	1		
25	T163336	Torsion Spring	2		
26	AT209022	Seat Kit	1		
27	AT209025	Seat Knob Kit	1		
28	37H121	Screw	2		
29	AT209225	Seat Knob Kit	1		
30	M453T	Lock Nut	3		
31	AT361336	Cushion	1		
32	AT361340	Cushion	1		
33	AT361341	Guide Kit	1		
34	AT361342	Head Restraint	1		
35	AT361343	Seat Back	1		
36	AT361356	Spring Kit	1		
37	AT361358	Seat Kit	1		
45	24M7036	Washer	2		9 X 16 X 1.600 MM
46	37M7340	Bolt	4		
47	AT227063	Lever	2		
48	AT321224	Push Switch	1		
49	AT325662	Handle	1		
50	AT325663	Lever	1		
51	AT325664	Knob	1		
52	AT325665	Spacer	1		
53	AT325666	Bracket	1		
54	AT325667	Knob	1		
55	AT325668	Pin	1		
56	AT325669	Cover	1		
57	AT325670	Cover	1		
58	AT325671	Cover	1		
59	AT325677	Package Of Parts	1		
60	AT330808	Bracket	1		
61	AT341684	Armrest Kit	1		
62	AT351061	Pivot	1		
63	T215154	Screw	3		
64	AT353410	Bracket	1		
65	H77698	Tie Band	2		
66	T209539	Cover	1		
67	T214514	Label	1		
68	.....	Control	1		(ORDER AT209022)

Key	Part No.	Part Name	Qty.	Serial No.	Remarks
1	19M7797	Screw	2		M6 X 40
2	19M7799	Screw	3		M8 X 45
3	19M7865	Screw	3		M8 X 16
4	21M7292	Screw	2		M6 X 16
5	24H1296	Washer	3		11/32" X 1-3/8" X 0.134"
6	24M7100	Washer	2		6.600 X 22 X 2 MM
7	24M7296	Washer	3		10.500 X 30 X 2.500 MM
8	28H3450	Spacer	3		0.364" X 0.540" X 1/2"
9	37M7333	Screw	32		
10	AT227669	Louver	6		
11	AT325667	Knob	2		
12	AT362867	Air Duct	1		(SUB FOR AT350850)
13	21M7403	Screw	2		M6 X 40
14	T239329	Air Duct	1		
15	AZ43305	Nozzle	4		
16	M84972	Nut	2		
17	T196079	Nut	2		
18	T216111	Panel	1		
19	T227679	Control Console	1		
20	T228567	Seal	2		
21	24H1821	Washer	2		9/32" X 47/64" X 1/16"
22	T239330	Plate	1		

---

<i>Key</i>	<i>Part No.</i>	<i>Part Name</i>	<i>Qty.</i>	<i>Serial No.</i>	<i>Remarks</i>
1	14M7296	Flange Nut	4		M10
2	19M7812	Screw	4		M10 X 100
3	24M7296	Washer	4		10.500 X 30 X 2.500 MM
4	T204150	Cover	1		

---

---

Key	Part No.	Part Name	Qty.	Serial No.	Remarks
1	19M7868	Screw	3		M8 X 30
2	19M7862	Screw	4		M6 X 20
3	AT302794	Precleaner	1		
4	RE40281	Clamp	2		
5	RE52702	Clamp	1		
8	AT359772	Plate	1		
10	T224882	Air Duct	1		
11	T224884	Air Duct	1		
12	T238611	Screen Shield	1		

---

Key	Part No.	Part Name	Qty.	Serial No.	Remarks
1	T232264	Isolator	1		
2	T246687	Isolator	1		
3	T246682	Isolator	1		
4	T234281	Isolator	1		
5	T230322	Retainer	29		(LH)
6	T234282	Isolator	1		
7	T216550	Isolator	1		
8	T216551	Isolator	1		(RH)
9	T234327	Isolator	1		
10	T232291	Isolator	1		(LH)
11	T258510	Isolator	1		(RH) (SUB FOR T232292)
12	T232266	Isolator	1		
13	24H1314	Washer	4		13/32" X 1-3/4" X 7/64"
14	19M7785	Screw	4		M10 X 25
15	.....	Isolator	4		(MAKE FROM T22649) (CTL 1.8 ft.)
16	.....	Isolator	2		(MAKE FROM T22649) (CTL 0.92 ft.)
17	.....	Isolator	2		(MAKE FROM DT5136) (CTL 2.9 ft.)
18	T241135	Isolator	1		
19	T241133	Isolator	1		

---

<i>Key</i>	<i>Part No.</i>	<i>Part Name</i>	<i>Qty.</i>	<i>Serial No.</i>	<i>Remarks</i>
1	03M7083	Bolt	2		M12 X 35
2	14M7299	Flange Nut	2		M12
3	19M7791	Bolt	6		M12 X 40
4	T206642	Plate	2		

---

Key	Part No.	Part Name	Qty.	Serial No.	Remarks
1	14M7303	Flange Nut	4		M6
2	19H1948	Cap Screw	4		1/4" X 3/4"
3	14M7100	Nut	4		M4
4	19M7865	Screw	2		M8 X 16
5	.....	Antenna	1		(ORDER AT379617 AND 24H1296) (AT199388 NLA)
8	AT188759	Speaker	2	-623514	
	AT342588	Speaker	2	623515-	
9	AT358008	Radio Speaker WRG Harness	1		
10	TT101176	Nut	8		(SUB FOR R53528)
11	T180338	Bracket	2		
12	T180420	Bracket	1		
13	AT224894	Converter	1		
14	T182870	Isolator	1		
15	T182888	Screw	8		
16	T204635	Bracket	1		
17	R44302	Tie Band	1		
18	.....	Radio	1	-623514	AM/FM/WB w/ CD Player, (SUB RE289629) (RE227953 NLA)
	RE289629	Radio	1	623515-	AM/FM/WB w/ CD Player
19	57M8174	Elec. Connector Housing	2		Speakers
	57M7724	Elec. Connect Locking Device	2		
	57M7501	Elec. Connector Terminal	4		
20	57M8012	Electrical Connector Assy	1		To Roof Harness
	57M8013	Elec. Connect Locking Device	1		
	.....	Elec. Connector Terminal	3		
	R78069	Elec. Connector Cavity Plug	3		
21	57M8781	Electrical Connector Assy	1		Radio
	.....	Elec. Connector Terminal	8		
22	T182871	Isolator	1		
23	T182909	Clip	6		
24	T121467	Plug	2		
25	AT337116	Field Installation Kit	1		AM/FM/WB w/ CD Player, (WHOLE GOODS)

20 Safety, Convenience & Miscellaneous  
2004 Warning Devices Including Horn & Reverse Alarm

---

<i>Key</i>	<i>Part No.</i>	<i>Part Name</i>	<i>Qty.</i>	<i>Serial No.</i>	<i>Remarks</i>
1	19M7865	Screw	1		M8 X 16
2	AT226282	Horn	1		

---

Key	Part No.	Part Name	Qty.	Serial No.	Remarks
1	14M7396	Lock Nut	2		M8
2	21M7344	Screw	2		M6 X 25
3	24M7139	Washer	2		6.400 X 18 X 1.600 MM
4	24M7298	Washer	2		8.400 X 25 X 2 MM
5	AT301914	Bracket	1		
6	JD5929	SMV Emblem	1		
<b>10</b>	<b>AT352645</b>	<b>SMV Emblem</b>	<b>1</b>		<b>(WHOLE GOODS)</b>

**21 Vehicle Main Hydraulic System  
2162 Hydraulic Selective Control & Load Holding Valves**

Key	Part No.	Part Name	Qty.	Serial No.	Remarks
1	AT351889	Manifold	1		
2	AH125760	Hyd. Quick-Connect Coupler	2		
3	AN302302	Compensator	1		
4	AN302301	Seal Kit	1		
	AT195140	Check Valve	1		
	AT195141	Seal Kit	1		
5	T187815	O-Ring	1		
	AT224570	Check Valve	1		
	AT224862	Seal Kit	1		
6	AT224863	Check Valve	1		
	AT224864	Seal Kit	1		
7	AT318788	Solenoid Valve	1		Park Brake Solenoid
	AT224873	Seal Kit	1		
8	AT338547	Solenoid Valve	2		
	AT224873	Seal Kit	1		
	AT341778	Solenoid Valve	1		
9	AT224862	Seal Kit	1		
	AT333809	Solenoid Valve Coil	1		
	T225291	Nut	1		
10	AT196943	Seal Kit	1		
	AT343831	Pressure Relief Valve	1	-622553	(AT341783 NLA)
	AT365436	Pressure Relief Valve	1	622554-	
11	AT196943	Seal Kit	1		
	R77175	Cover	2		

Key	Part No.	Part Name	Qty.	Serial No.	Remarks
1	19M7774	Screw	4		M6 X 12
2	19M7833	Screw	3		M6 X 35
3	19M8786	Screw	4		M6 X 70
4	24H1283	Washer	1		7/32" X 1/2" X 0.049"
5	24M7139	Washer	7		6.400 X 18 X 1.600 MM
6	37H212	Screw	1		
7	AT209965	Ground Cable	1		150 MM (5.906")
8	AT347687	Box	1		GlobalTRACS™ (GTT)
9	AT342875	Bracket	1		
10	AT344868	Antenna	1		
11	AT344872	Wiring Harness	1		GlobalTRACS™ (GTT)
12	AT359710	Wiring Harness	1		MIG
13	H77698	Tie Band	4		
14	PF81226	Multi-Functional Controller	1		Machine Information Gateway (MIG)
15	T234392	Spacer	3		
16	T234394	Grommet	6		
20	.....	Kit	1		JDLink™ Ultimate, Order Through Product Configurator

---

Key	Part No.	Part Name	Qty.	Serial No.	Remarks
1	T157465	Cutting Edge	1		2690 mm
2	T217625	Skid Plate	2		
3	T213143	Label	1		
<b>50</b>	<b>AT341083</b>	<b>Loader Bucket</b>	<b>1</b>		<b>3.0 yd<sup>3</sup>, (WHOLE GOODS)</b>

---

Key	Part No.	Part Name	Qty.	Serial No.	Remarks
1	AT300238	Field Installation Kit	1		60 in. Frame, 48 in. Fork, (WHOLE GOODS)
	AT300237	Field Installation Kit	1		60 in. Frame, 60 in. Fork, (WHOLE GOODS)
	AT320620	Field Installation Kit	1		90 in. Frame, 48 in. Fork, (WHOLE GOODS)
2	AT320619	Field Installation Kit	1		90 in. Frame, 60 in. Fork, (WHOLE GOODS)
	AT308065	Fork	2		48 in., (CA)
	AT308066	Fork	2		60 in., (CA)
3	AT332401	Kit	1		
4	AT310060	Frame	1		60 in., (CA)
	AT320193	Frame	1		90 in., (CA)
5	T227912	Label	1		Load Capacity

Key	Part No.	Part Name	Qty.	Serial No.	Remarks
1	19M7489	Cap Screw	3		M16 X 45
2	19M7790	Screw	3		M12 X 35
3	24M7240	Washer	3		13 X 25 X 3 MM
4	AH222122	Hydraulic Cylinder	1		Components On Separate Page
5	AT210275	Pin	1		
6	AT322719	Pin Fastener	2		
7	AT324266	Cover	1		
8	T225429	Shim	2		
9	<b>AT351308</b>	<b>Quick Coupler</b>	<b>1</b>		<b>(CA)</b>
10	H89151	Dowel Pin	2		
11	JD7759	Lubrication Fitting	2		
12	T176064	Bushing	3		
13	T214207	Pin Fastener	2		
14	T225431	Shim	8		
15	T226523	Shim	4		
16	T61226	Snap Ring	2		

Key	Part No.	Part Name	Qty.	Serial No.	Remarks
1	AH142159	Piston	2		
2	H154514	Seal	1		
3	H156058	Wear Ring	1		
4	H156586	Seal	1		
5	H164982	Snap Ring	1		
6	H210874	Hydr. Cylinder Rod Guide	1		
7	H211156	Snap Ring	1		
8	H63262	O-Ring	1		56.820 X 2.616 MM (2.237" X 0.103")
9	U13461	Back-Up Ring	1		57.430 X 62.850 X 1.270 MM (2.261" X 2.474" X 0.050")
10	H170535	Nut	2		
11	H219217	Rod	2		
12	R93633	O-Ring	2		
15	AH222122	Hydraulic Cylinder	1		
16	AH148823	Seal Kit	1		Rod
18	AH212088	Hydraulic Cylinder Kit	1		Bore

Key	Part No.	Part Name	Qty.	Serial No.	Remarks
1	19M7488	Cap Screw	5		M16 X 40
2	19M7489	Cap Screw	4		M16 X 45
3	19M7496	Cap Screw	12		M12 X 45
4	19M7786	Screw	4		M10 X 30
5	24M7240	Washer	12		13 X 25 X 3 MM
6	24M7296	Washer	4		10.500 X 30 X 2.500 MM
7	AT203483	Bearing	2		
8	AT207719	Pin	2		
9	AT301818	Pin	1		
10	AT307818	Pin	2		
11	AT318925	Pin Fastener	2		
12	AT345967	Pin	2		
13	<b>AT346037</b>	<b>Frame</b>	<b>1</b>		<b>(CA)</b>
14	E53801	Elbow Fitting	3		3.175 MM (1/8")
15	JD7759	Lubrication Fitting	6		
16	T130057	Shim	AR		
17	T130058	Shim	AR		
18	T130059	Shim	AR		
19	T157029	Seal	2		
20	T157030	Spacer	2		
21	T157234	Cover	1		
22	T176064	Bushing	9		16.300 X 28.600 X 21.900 MM (0.642" X 1.126" X 0.862")
23	T182265	Bushing	1		63.623 X 74.160 X 34.500 MM (2.505" X 2.920" X 1.358")
24	T182516	Pin	1		
25	T200888	Cover	2		
26	T223722	Shim	2		
27	T226526	Shim	2		
28	T225434	Shim	10		
29	T60752	Seal	2		

Key	Part No.	Part Name	Qty.	Serial No.	Remarks
1	19M7488	Cap Screw	1		M16 X 40
2	AT207686	Pin	1		
3	T72414	Bushing	3		
4	AT350467	Bushing	2		
5	AT350473	Bushing	2		
6	AT350477	Bushing	2		
7	T176064	Bushing	1		16.300 X 28.600 X 21.900 MM (0.642" X 1.126" X 0.862") High Lift
8	T210796	Label	2		
9	T223722	Shim	2		
<b>15</b>	<b>AT338847</b>	<b>Loader Boom</b>	<b>1</b>		<b>(CA)</b>

Key	Part No.	Part Name	Qty.	Serial No.	Remarks
1	15H558	Pipe Plug	1		1/8"
2	19M8029	Cap Screw	1		M16 X 30
3	19M8029	Cap Screw	1		M16 X 30
4	AT102827	Pin Fastener	1		
5	AT207718	Pin	1		
6	AT228893	Ring	2		
7	14M7572	Lock Nut	1		M5
8	19M9304	Cap Screw	1		M5 X 90
9	24M7027	Washer	2		5.300 X 10 X 1 MM
<b>10</b>	<b>AT337720</b>	<b>Bellcrank</b>	<b>1</b>		<b>(CA)</b>
11	AT350481	Bushing	1		
<b>12</b>	<b>AT337759</b>	<b>Link</b>	<b>1</b>		<b>(CA)</b>
13	AT350474	Bushing	2		
14	T146246	Washer	1		17 X 57.100 X 6.500 MM (0.669" X 2.248" X 0.256")
15	T146246	Washer	1		17 X 57.100 X 6.500 MM (0.669" X 2.248" X 0.256")
16	T226523	Shim	2		
17	T226526	Shim	2		

Key	Part No.	Part Name	Qty.	Serial No.	Remarks
1	14M7400	Lock Nut	3		M10
2	19M7807	Screw	3		M10 X 60
3	24M7239	Washer	3		10.700 X 21 X 2.500 MM
4	R26448	O-Ring	9		
5	T77613	O-Ring	6		
6	38H1026	Tee Fitting	1		
7	T77858	O-Ring	4		
8	U12547	O-Ring	5		
9	38H1090	Elbow Fitting	1		
10	T78784	O-Ring	1		
11	U13639	O-Ring	1		
12	38H1160	Adapter Fitting	3		
13	38H1215	Adapter Fitting	2		
14	38H1216	Adapter Fitting	1	-623742	
	38H1196	Adapter Fitting	1	623743-	
15	R29936	O-Ring	1		
16	T76938	O-Ring	3	-623742	
	T76938	O-Ring	2	623743-	
19	AT353746	Check Valve	2		
20	R27175	Drain Plug	1		
21	R27218	Fitting Plug	3		
22	38H1004	Elbow Fitting	1		
23	38H1572	Tee Fitting	1		
24	T78612	O-Ring	1	623743-	
35	AT317146	Hyd Actuated Control Valve	1		(ASSY)
	AT314008	Valve	1		Inlet Valve Section, Components On Separate Page
	AT317149	Valve	1		Boom Valve Section, Components On Separate Page
	AT314009	Valve	1		Bucket Valve Section, Components On Separate Page
	AT314022	Flow Control Hyd. Valve	1		Outlet Valve Section, Components On Separate Page
	AT314048	Rod	4		Two Spool Stud Assembly

Key	Part No.	Part Name	Qty.	Serial No.	Remarks
1	14M7400	Lock Nut	3		M10
2	19M7807	Screw	3		M10 X 60
3	24M7239	Washer	3		10.700 X 21 X 2.500 MM
4	R26448	O-Ring	13		
5	T77613	O-Ring	10		
6	38H1026	Tee Fitting	1		
7	T77858	O-Ring	8		
8	U12547	O-Ring	9		
9	38H1090	Elbow Fitting	1		
10	T78784	O-Ring	1		
11	U13639	O-Ring	1		
12	38H1160	Adapter Fitting	7		
13	38H1215	Adapter Fitting	2		
14	38H1216	Adapter Fitting	1	-623742	
	38H1196	Adapter Fitting	1	623743-	
15	R29936	O-Ring	1		
16	T76938	O-Ring	3	-623742	
	T76938	O-Ring	2	623743-	
19	AT353746	Check Valve	2		
20	R27175	Drain Plug	1		
21	R27218	Fitting Plug	3		
22	38H1004	Elbow Fitting	1		
23	38H1572	Tee Fitting	1		
24	38H1163	Adapter Fitting	4		
25	T78612	O-Ring	1	623743-	
35	AT317148	Hyd Actuated Control Valve	1		(ASSY)
	AT314008	Valve	1		Inlet Valve Section, Components On Separate Page
	AT317149	Valve	1		Boom Valve Section, Components On Separate Page
	AT314009	Valve	1		Bucket Valve Section, Components On Separate Page
	AT314046	Valve	2		Auxiliary Valve Section, Components On Separate Page
	AT314022	Flow Control Hyd. Valve	1		Outlet Valve Section, Components On Separate Page
	AT314026	Rod	4		Four Spool Stud Assembly

Key	Part No.	Part Name	Qty.	Serial No.	Remarks
1	AT314046	Valve	1		
	AT314013	Seal Kit	1		Work Section Seal Kit Pilot End Cap Seal Kit
	AT314021	Hydraulic Cylinder Cap	1		
2	AT209750	Pressure Relief Valve	2		
	AT209748	Seal Kit	2		
3	AT314011	Valve	1		
4	AT314012	Valve	2		
5	T171072	Cap Screw	2		6.350 X 114.300 MM (1/4" X 4-1/2")

Key	Part No.	Part Name	Qty.	Serial No.	Remarks
1	12H327	Lock Washer	9		3/4"
2	12H328	Lock Washer	1		7/8"
3	14M7397	Lock Nut	4		M6
4	19M7866	Screw	2		M8 X 20
5	62H1054	Adapter Fitting	1		
6	R26448	O-Ring	10		11.887 X 1.981 MM (0.468" X 5/64")
7	63H1001	Fitting	9		
9	AT225432	Hydr./Pilot Control Valve	1		Components On Separate Page
10	AT336503	Hydraulic Hose - Fabricate	1		
11	T77613	O-Ring	9		9.250 X 1.780 MM (0.364" X 0.070")
12	AT336506	Hydraulic Hose - Fabricate	1		
13	T77857	O-Ring	1		12.420 X 1.780 MM (0.489" X 0.070")
14	AT336507	Hydraulic Hose - Fabricate	8		
15	AT341524	Plate	1		
16	AT352891	Plate	1		
18	T196079	Nut	2		M8
19	T200729	Label	1		
21	T230554	Conduit	1		
22	.....	Isolator	1		(MAKE FROM H81330) (CTL)
23	T78716	Nut	1		20.625 MM (13/16")
24	T81029	Nut	9		17.475 MM (11/16")

Key	Part No.	Part Name	Qty.	Serial No.	Remarks
1	38H1418	Fitting	2		
2	38H1030	Tee Fitting	3		
3	T77613	O-Ring	13		
4	38H1094	Elbow Fitting	2		
5	38H1160	Adapter Fitting	2		
6	R26448	O-Ring	2		
7	38H1163	Adapter Fitting	2		
8	T77858	O-Ring	2		
9	U12547	O-Ring	2		
10	38H1309	Adapter Fitting	2		
11	R28782	O-Ring	2		
12	38H1546	Tee Fitting	1		
13	T77932	O-Ring	1		
14	AT166149	Hydraulic Hose - Fabricate	2		
15	AT211219	Wiring Harness	1		Not Illustrated
16	AT219757	Toggle/Rocker Switch	1		
17	AT220526	Switch	1		Detent, Not Illustrated
18	AT314013	Seal Kit	1		Fifth Function Valve Section, Not Illustrated
19	AT316315	Solenoid Valve	1		Fifth Function Valve Section
	AT325146	Stud	4		
	AT326581	MFWD Solenoid WRG Harness	2		
20	AT358769	Hydraulic Hose - Fabricate	1	-623632	
	AT371649	Hydraulic Hose - Fabricate	1	623633-	
21	AT358773	Hydraulic Hose - Fabricate	2		
22	AT365542	Wiring Harness	1		Jumper Harness, Not Illustrated
50	AT365108	Field Install Template Kit	1		Electric Fifth Function, (WHOLE GOODS)

Key	Part No.	Part Name	Qty.	Serial No.	Remarks
1	21M7285	Screw	4		M6 X 12
2	38H1160	Adapter Fitting	1		
3	R26448	O-Ring	2		11.887 X 1.981 MM (0.468" X 5/64")
4	T77613	O-Ring	7	-624385	9.250 X 1.780 MM (0.364" X 0.070")
	T77613	O-Ring	6	624386-	9.250 X 1.780 MM (0.364" X 0.070")
5	AT300921	Clamp	1		
6	21M7258	Screw	1		M4 X 8
7	AT315458	Handle	1		Joystick (w/o FNR), Components On Separate Page
8	AT341528	Plate	1		
9	AT342497	Cover	1		
10	AT344124	Hydraulic Hose - Fabricate	1		17.475" X 838 MM (33") X 17.475"
11	AT344125	Hydraulic Hose - Fabricate	1	-624385	17.475" X 838 MM (33") X 13/16"
	AT363800	Hydraulic Hose - Fabricate	1	624386-	
12	T77857	O-Ring	1	-624385	12.420 X 1.780 MM (0.489" X 0.070")
	T77857	O-Ring	2	624386-	12.420 X 1.780 MM (0.489" X 0.070")
13	.....	Hydr./Pilot Control Valve	1	-624385	(AT356032 NLA) (SUB AT362746), Components On Separate Page
	AT362746	Hydr./Pilot Control Valve	1	624386-	
14	T197182	Label	1		Joystick Control w/ FNR
15	T203670	Label	1		Joystick Control w/o FNR
16	T242089	Cover	1		
17	AT336507	Hydraulic Hose - Fabricate	4		
18	38H1160	Adapter Fitting	1	-624385	
	38H1173	Adapter Fitting	1	624386-	
50	AT337445	Field Installation Kit	1		(WHOLE GOODS)

Key	Part No.	Part Name	Qty.	Serial No.	Remarks
1	12H327	Lock Washer	2		3/4"
2	14M7397	Lock Nut	4		M6
3	14M7400	Lock Nut	1		M10
4	19M7786	Screw	2		M10 X 30
5	19M7805	Screw	1		M10 X 45
6	28H3383	Bushing	1		0.493" X 0.675" X 3/4"
7	38H1418	Fitting	2		
8	38H1023	Tee Fitting	1		
9	R26448	O-Ring	6		11.887 X 1.981 MM (0.468" X 5/64")
10	T77613	O-Ring	7		9.250 X 1.780 MM (0.364" X 0.070")
11	38H1160	Adapter Fitting	4		
12	38H1163	Adapter Fitting	2		
13	T77858	O-Ring	8		18.770 X 1.780 MM (0.739" X 0.070")
14	U12547	O-Ring	2		23.470 X 2.946 MM (0.924" X 0.116")
18	38H1276	Adapter Fitting	2		
19	63H1001	Fitting	2		
21	AT228250	Hydr./Pilot Control Valve	1		Auxiliary Single Lever Controller, Components On Separate Page
22	AT313424	Hydraulic Hose - Fabricate	2		
23	AT314046	Valve	1		Auxiliary Valve Section, Components On Separate Page
	AT105438	Rod	1		
24	38H1642	Adapter Fitting	1		
25	T77857	O-Ring	1		
28	AT322202	Oil Line	1		
29	AT322203	Oil Line	1		
30	AT336507	Hydraulic Hose - Fabricate	2	623743-	
31	AT340251	Hydraulic Hose - Fabricate	2		
32	AT341527	Plate	1		
33	AT342616	Oil Line	1		
34	AT342617	Oil Line	1		
35	T174275	Lock Washer	2		30.950 MM (1-7/32")
36	T215434	Clamp	2		
37	T78707	Nut	2		30.175 MM (1-3/16")
38	T81029	Nut	2		17.475 MM (11/16")
39	U46753	Hose Clamp	2		
40	AT364885	Hydraulic Hose - Fabricate	1	-623742	(AT345001 NLA)
	AT366773	Hydraulic Hose - Fabricate	1	623743-	
<b>50</b>	<b>AT337465</b>	<b>Field Installation Kit</b>	<b>1</b>		<b>(WHOLE GOODS)</b>

Key	Part No.	Part Name	Qty.	Serial No.	Remarks
1	AT227925	Lever	1		w/o Switch
	AT227926	Lever	1		w/ Switch
2	AT227930	Plate	1		
5	AT227933	Plate	1		
7	AT325612	Bolt	2		
8	AT303619	Boot Kit	2		
9	AT227928	Armature	1		
10	AT227927	Solenoid	1		
11	AT337443	Field Installation Kit	1		Detent, (WHOLE GOODS) (SUB FOR AT305603)

Key	Part No.	Part Name	Qty.	Serial No.	Remarks
1	AT332291	Hyd Actuated Control Valve	1		Components On Separate Page
2	AT227717	Hydraulic Accumulator	1		
	AT196760	Valve Kit	1		
3	AT225446	Hydraulic Hose - Fabricate	1		
4	AT228199	Hydraulic Hose - Fabricate	1		
5	AT228199	Hydraulic Hose - Fabricate	1		
6	AT308419	Oil Line	1		
7	AT308447	Oil Line	1		
8	AT308533	Hydraulic Hose	1		
9	38H1007	Elbow Fitting	1		
10	U12547	O-Ring	1		
11	T77858	O-Ring	1		
12	38H1009	Elbow Fitting	1		
13	T77814	O-Ring	1		
14	R26448	O-Ring	1		
15	38H1163	Adapter Fitting	1		
16	T77858	O-Ring	1		
17	U12547	O-Ring	1		
18	38H1179	Adapter Fitting	1		
19	T76938	O-Ring	1		
20	U12547	O-Ring	1		
21	38H1193	Adapter Fitting	1		
22	T77858	O-Ring	1		
23	R26906	O-Ring	1		
24	38H1194	Adapter Fitting	1		
25	T77858	O-Ring	1		
26	R29936	O-Ring	1		
27	T146490	Clamp	2		
28	19M7804	Screw	4		M10 X 40
29	24M7296	Washer	6		10.500 X 30 X 2.500 MM
30	14M7400	Lock Nut	6		M10
31	19M7898	Screw	2		M10 X 130
32	T180944	Label	1		
33	T77858	O-Ring	2		
34	T76938	O-Ring	2		
35	T158047	Adapter Fitting	1		
36	R26448	O-Ring	1		
37	AT223535	Pressure Switch	1		
38	R26287	O-Ring	1		
39	T146792	Safety Sign	2		
41	RE60700	Diagnostic Coupling	1		
42	R77175	Cover	1		

Key	Part No.	Part Name	Qty.	Serial No.	Remarks
1	14M7400	Lock Nut	2		M10
2	19M7784	Screw	4		M10 X 20
3	19M7836	Screw	2		M10 X 110
4	24M7296	Washer	2		10.500 X 30 X 2.500 MM
5	38H1415	Fitting	2		
6	38H1004	Elbow Fitting	1	-623742	
	38H1004	Elbow Fitting	2	623743-	
7	R26448	O-Ring	6		11.887 X 1.981 MM (0.468" X 5/64")
8	T77613	O-Ring	10		9.250 X 1.780 MM (0.364" X 0.070")
9	38H1160	Adapter Fitting	3	-623742	
	38H1160	Adapter Fitting	2	623743-	
10	38H1173	Adapter Fitting	2		
11	T77857	O-Ring	2		12.420 X 1.780 MM (0.489" X 0.070")
12	AT167553	Hydraulic Hose - Fabricate	2		17.475" X 629 MM (24-3/4") X 17.475"
13	AT301930	Hydraulic Hose - Fabricate	2		17.475" X 1117 MM (44") X 17.475"
14	AT308841	Oil Line	1		
15	AT308842	Oil Line	1		
16	AT311093	Oil Line	1		
17	AT311094	Oil Line	1		
18	AT334494	Control Valve	1		
19	AT226265	Hydraulic Pressure Valve	1		
	AT196943	Seal Kit	1		
20	AT226266	Solenoid Valve	1		
	AT225083	Seal Kit	1		
	AT333810	Solenoid Valve Coil	1		
21	T225291	Nut	1		12.700 MM (1/2")
22	H75541	Clamp	8		
<b>50</b>	<b>AT337424</b>	<b>Field Installation Kit</b>	<b>1</b>		<b>(WHOLE GOODS)</b>

Key	Part No.	Part Name	Qty.	Serial No.	Remarks
1	14M7296	Flange Nut	4		M10
2	19M7805	Screw	3		M10 X 45
3	19M7810	Screw	2		M10 X 80
4	19M7835	Screw	4		M10 X 35
5	19M7979	Screw	2		M8 X 55
6	24M7238	Washer	2		8.700 X 17 X 2 MM
7	24M7296	Washer	2		10.500 X 30 X 2.500 MM
8	28H3381	Spacer	2		0.493" X 0.675" X 5/8"
9	38H1418	Fitting	2		
10	38H1276	Adapter Fitting	2		
11	T77858	O-Ring	8		
12	TY22494	Hose Clamp	2		(SUB FOR TY22493)
13	AT191285	Hydraulic Hose - Fabricate	2		
14	AT208691	Hydraulic Hose - Fabricate	2		
15	AT210400	Oil Line	1		
16	AT224318	Bracket	2		
17	AT307067	Oil Line	1		
18	AT308285	Oil Line	1		
19	AT308287	Oil Line	1		
20	AT315175	Hydraulic Hose - Fabricate	1		
21	AT316244	Oil Line	1		
22	AT316245	Oil Line	1		
23	AT321007	Hydraulic Hose	1		
24	AT321120	Oil Line	1		
25	AT321121	Oil Line	1		
26	AT321145	Oil Line	1		
27	AT323352	Hydraulic Hose - Fabricate	2		
28	AT364885	Hydraulic Hose - Fabricate	1	-623742	(SUB FOR AT345001)
	AT366773	Hydraulic Hose - Fabricate	1	623743-	
29	T102005	Guide	4		
30	T147188	Clamp	2		
31	T148712	Washer	4	-623742	11.215 X 33.200 X 3 MM (0.442" X 1.307" X 0.118")
	24M7296	Washer	4	623743-	10.500 X 30 X 2.500 MM
32	T160549	Clamp	1		
33	T167921	Clamp	2		
34	T174275	Lock Washer	2		30.950 MM (1-7/32")
35	T67995	Clamp	2		
36	T76938	O-Ring	5		
37	T78707	Nut	2		30.175 MM (1-3/16")
38	TY22494	Hose Clamp	3		

Key	Part No.	Part Name	Qty.	Serial No.	Remarks
1	14M7296	Flange Nut	4		M10
2	14M7298	Flange Nut	4		M8
3	14M7400	Lock Nut	2		M10
4	19M7803	Screw	4		M8 X 70
5	19M7805	Screw	6		M10 X 45
6	19M7835	Screw	4		M10 X 35
7	24M7238	Washer	8		8.700 X 17 X 2 MM
8	24M7296	Washer	4		10.500 X 30 X 2.500 MM
9	28H3381	Spacer	2		0.493" X 0.675" X 5/8"
10	28H3383	Bushing	2		0.493" X 0.675" X 3/4"
11	38H1418	Fitting	2		
12	38H1276	Adapter Fitting	1		
13	T77858	O-Ring	7		
14	AR89602	Clamp	6		
15	AT210400	Oil Line	2		
17	AT219783	Hydraulic Hose - Fabricate	2		
18	AT224318	Bracket	2		
19	AT227536	Hydraulic Hose - Fabricate	2		
20	AT306599	Hydraulic Hose - Fabricate	2		
21	AT306812	Hydraulic Hose - Fabricate	2		
22	AT308284	Oil Line	1		
24	AT308286	Oil Line	1		
26	AT308419	Oil Line	1		
28	AT308447	Oil Line	1		(SUB FOR AT343709)
29	AT346960	Hydraulic Hose - Fabricate	2		(SUB FOR AT343713)
30	AT359951	Oil Line	1		(SUB FOR AT343714)
31	AT359952	Oil Line	1		(SUB FOR AT343715)
32	AT359953	Oil Line	1		
33	AT359954	Oil Line	1		
34	AT364885	Hydraulic Hose - Fabricate	1	-623742	(SUB FOR AT345001)
	AT366773	Hydraulic Hose - Fabricate	1	623743-	
35	T102005	Guide	2		
36	T105773	Guide	4		
37	T13976	Bushing	2		
38	T147188	Clamp	4		
39	T167921	Clamp	2		
40	T170143	Clamp	2		
41	T174275	Lock Washer	2		30.950 MM (1-7/32")
42	T76938	O-Ring	5		
43	T77932	O-Ring	2		
44	T78707	Nut	2		
45	TY22494	Hose Clamp	2		
46	U46753	Hose Clamp	4		

Key	Part No.	Part Name	Qty.	Serial No.	Remarks
1	14M7400	Lock Nut	1		M10
2	19M7805	Screw	1		M10 X 45
3	28H3383	Bushing	1		0.493" X 0.675" X 3/4"
4	38H1418	Fitting	2		
5	38H1276	Adapter Fitting	2		
6	T77858	O-Ring	6		
7	AT321388	Hydraulic Hose - Fabricate	2		
8	T174275	Lock Washer	2		
9	T78707	Nut	2		
10	U46753	Hose Clamp	2		
50	AT322227	Field Installation Kit	1		(WHOLE GOODS)

Key	Part No.	Part Name	Qty.	Serial No.	Remarks
1	12H327	Lock Washer	2		3/4"
2	19M7785	Screw	2		M10 X 25
3	AT62123	Clamp	1		
4	38H1004	Elbow Fitting	4		
5	R26448	O-Ring	3		11.887 X 1.981 MM (0.468" X 5/64")
6	T77613	O-Ring	8		9.250 X 1.780 MM (0.364" X 0.070")
7	38H1016	Tee Fitting	1		
8	38H1285	Union Fitting	2		
9	AT323757	Hydraulic Hose - Fabricate	1		17.475" X 600 MM (23-1/2") X 17.475"
10	AT323756	Hydraulic Hose - Fabricate	1		17.475" X 810 MM (32") X 17.475"
11	AT323817	Hydraulic Hose - Fabricate	1		17.475" X 317 MM (12-1/2") X 17.475"
12	AT324137	Cable	1		
13	AT324641	Hydraulic Hose - Fabricate	2		
15	T204315	Plate	1		
16	.....	Hose Guard	1		(MAKE FROM PG-188) (CTL)
17	T81029	Nut	2		17.475 MM (11/16")
25	<b>AT330154</b>	<b>Field Installation Kit</b>	<b>1</b>		<b>(WHOLE GOODS)</b>

Key	Part No.	Part Name	Qty.	Serial No.	Remarks
1	15H558	Pipe Plug	2		1/8"
2	19M7489	Cap Screw	2		M16 X 45
3	38H1007	Elbow Fitting	1		
4	T77858	O-Ring	3		18.770 X 1.780 MM (0.739" X 0.070")
5	U12547	O-Ring	2		23.470 X 2.946 MM (0.924" X 0.116")
6	38H1052	Elbow Fitting	1		
7	R29936	O-Ring	2		29.743 X 2.946 MM (1.171" X 0.116")
8	38H1053	Elbow Fitting	3		
9	R29936	O-Ring	2		29.743 X 2.946 MM (1.171" X 0.116")
10	T78612	O-Ring	3		29.870 X 1.780 MM (1.176" X 0.070")
11	AT336661	Pin	2		
12	AT350470	Bushing	2		
13	AT350476	Bushing	2		
14	T176064	Bushing	2		16.300 X 28.600 X 21.900 MM (0.642" X 1.126" X 0.862")
15	T226522	Shim	4		
30	AH227111	Hydraulic Cylinder	1		Components On Separate Page
32	AH227925	Hydraulic Cylinder	2		Components On Separate Page

Key	Part No.	Part Name	Qty.	Serial No.	Remarks
1	AH157291	Seal	1		
2	AH157292	Seal	1		
3	R85556	Bushing	1		89.776 X 105.130 X 110 MM (3.534" X 4.139" X 4.331")
4	AH224533	Rod	1		
8	AT153937	Shim	1		
9	H155879	Nut	1		
10	H163979	Seal	1		
11	H163980	Bushing	1		
12	H168220	Piston	1		
13	H208519	Hydr. Cylinder Rod Guide	1		
14	H88900	O-Ring	1		148.590 X 5.334 MM (5.850" X 0.210")
15	RE25146	Seal	1		
16	R85228	Wear Ring	1		
17	R98669	Back-Up Ring	1		151.310 X 159.690 X 1.650 MM (5.957" X 6.287" X 0.065")
18	T13624	Ball	1		7.145 MM (9/32")
19	T41326	O-Ring	1		164.694 X 3.531 MM (6-31/64" X 0.139")
20	22M7009	Set Screw	1		M12 X 12
21	.....	Ring	1		
22	.....	Back-Up Ring	1		
23	.....	Seal	1		
24	.....	Ring	1		
25	.....	Ring	1		
30	AH225717	Hydraulic Cylinder	1		
32	AH137210	Hydraulic Cylinder Kit	1		Bore
34	AH159192	Kit	1		Rod

Key	Part No.	Part Name	Qty.	Serial No.	Remarks
1	19M7788	Screw	2		M12 X 25
2	19M8017	Cap Screw	3		M12 X 20
3	24M7240	Washer	3		13 X 25 X 3 MM
4	AT312985	Bracket	1		
5	19M7560	Cap Screw	3		M6 X 16
6	21H1383	Screw	2		0.190" X 2"
7	24M7027	Washer	4		5.300 X 10 X 1 MM
8	24M7386	Washer	1		13 X 19 X 1.500 MM
9	A4365R	O-Ring	1		
10	AT312996	Arm	1		
11	AT313037	Sensor	1		
12	M135542	Lock Nut	2		4.826 MM (0.190")
13	M88102	Bushing	1		
14	P48347	O-Ring	1		
15	R72653	Snap Ring	1		
16	T210258	Plate	1		
17	T211396	Torsion Spring	1		
18	T211404	Plate	1		
19	T211405	Spacer	1		
20	AT312989	Bracket	1		

## Numerical Index

Part No.	Key	Page	Part No.	Key	Page	Part No.	Key	Page
AA21292	4	617	AH77869	6	49	AT162848	6	603
AA46694	7	321	AH89557	18	475	AT163872	10	599
AA46694	9	323	AH89557	19	477	AT163872	18	599
AHC10214	11	913	AL153660	7	559	AT165288	8	95
AHC10214	1	917	AL76568	6	605	AT166149	14	801
AHC10215	12	913	AL76568	9	607	AT167553	13	849
AHC10215	1	915	AM39653	21	677	AT167553	12	851
AH125760	2	671	AN207183	8	847	AT167553	13	853
AH137210	32	911	AN207184	8	847	AT169849	8	385
AH142159	1	721	AN302301	3	671	AT170005	4	533
AH146559	2	903	AN302302	3	671	AT172629	1	837
AH146559	2	909	AP22660	14	497	AT173193	5	561
AH146559	3	915	AR104650	13	197	AT173313	2	583
AH146563	3	903	AR21837	9	321	AT173354	4	471
AH146563	3	909	AR21837	37	323	AT173354	6	473
AH146563	4	915	AR21837	11	365	AT174697	2	597
AH148608	4	401	AR21837	4	367	AT175750	5	105
AH148823	16	721	AR21837	16	371	AT176801	7	817
AH149194	32	401	AR21837	11	433	AT176801	5	823
AH149815	34	903	AR21839	11	137	AT181313	9	407
AH149815	34	909	AR21839	10	321	AT183238	1	679
AH149815	2	915	AR21839	14	323	AT184015	3	355
AH150453	5	401	AR21839	1	339	AT188759	8	637
AH150932	5	917	AR21839	1	343	AT188759	8	641
AH150933	6	917	AR21839	12	369	AT189390	2	649
AH152445	1	905	AR21839	13	369	AT189487	3	649
AH152446	2	905	AR21839	22	371	AT190780	5	565
AH154232	8	915	AR21839	30	371	AT191102	12	595
AH154233	10	915	AR21839	16	675	AT191285	16	803
AH154241	2	917	AR50411	1	313	AT191285	13	807
AH156466	4	917	AR65507	3	183	AT191285	17	819
AH156874	32	905	AR65507	3	265	AT191285	13	861
AH156877	1	903	AR65507	1	290	AT191285	13	863
AH156877	1	909	AR65507	2	295	AT193500	4	609
AH157291	1	911	AR83396	3	439	AT195140	4	671
AH157292	2	911	AR83396	3	441	AT195141	4	671
AH159192	34	911	AR85327	4	351	AT195302	1	419
AH159448	11	369	AR85327	15	353	AT195442	7	575
AH159448	18	371	AR87079	1	315	AT195442	7	577
AH162914	7	369	AR89602	14	871	AT195894	6	565
AH162914	19	371	AR94101	18	487	AT196427	1	643
AH163672	36	903	AR94101	3	487	AT196760	6	839
AH163672	36	909	AT102827	3	749	AT196760	2	841
AH163672	11	915	AT102827	4	751	AT196760	2	843
AH165079	5	369	AT102827	3	753	AT196760	19	845
AH165079	20	371	AT102827	4	755	AT196943	10	671
AH170895	8	321	AT103107	9	899	AT196943	9	671
AH170895	5	323	AT103440	2	777	AT196943	15	849
AH212088	18	721	AT104051	2	777	AT196943	19	851
AH212089	34	401	AT105438	35	765	AT196943	16	853
AH212103	16	917	AT105438	35	767	AT196943	2	857
AH216299	34	905	AT105438	32	769	AT199388	5	635
AH222122	4	711	AT105438	18	803	AT199388	5	637
AH222122	4	713	AT105438	21	805	AT199388	5	639
AH222122	4	715	AT105438	19	819	AT199388	5	641
AH222122	5	717	AT105438	23	821	AT202789	4	471
AH222122	15	721	AT106365	4	561	AT202789	6	473
AH223400	10	707	AT116162	4	317	AT202827	4	919
AH223400	8	709	AT116162	2	53	AT202955	9	95
AH224533	4	911	AT116970	6	559	AT203130	5	919
AH225717	30	907	AT119378	11	837	AT203137	5	471
AH225717	30	911	AT124574	4	777	AT203247	1	699
AH226589	10	707	AT124574	15	785	AT203483	7	727
AH226589	8	709	AT125158	11	567	AT203483	8	729
AH227110	12	903	AT125158	11	569	AT203483	7	731
AH227110	12	909	AT125158	11	571	AT203483	7	733
AH227111	30	899	AT132864	12	443	AT206751	6	519
AH227111	30	901	AT135758	16	455	AT206818	26	475
AH227111	30	905	AT135758	16	457	AT206818	26	477
AH227112	3	905	AT135758	16	459	AT206818	27	479
AH227113	4	905	AT135758	16	461	AT206908	12	365
AH227114	30	399	AT135758	6	467	AT206908	8	367
AH227114	30	401	AT139694	7	385	AT206909	13	365
AH227116	13	401	AT143222	2	35	AT206909	5	367
AH227925	32	899	AT143577	2	521	AT206914	14	365
AH227925	32	901	AT145341	24	475	AT206914	11	367
AH227925	32	903	AT145341	24	477	AT206915	15	365
AH227925	32	907	AT145341	25	479	AT206915	9	367
AH227925	32	909	AT145341	23	497	AT207022	9	413
AH77869	18	325	AT153937	8	911	AT207023	4	37
AH77869	55	327	AT157226	1	645	AT207023	4	39
AH77869	17	329	AT160480	15	497	AT207023	4	41
AH77869	58	331	AT161638	27	677	AT207023	3	437
AH77869	55	333	AT162118	6	575	AT207330	3	93

## Numerical Index - Continued

<i>Part No.</i>	<i>Key</i>	<i>Page</i>	<i>Part No.</i>	<i>Key</i>	<i>Page</i>	<i>Part No.</i>	<i>Key</i>	<i>Page</i>
RE521756	6	186	RE52509	10	599	RE537834	22	179
RE521756	2	268	RE525094	28	199	RE538045	2	211
RE521756	3	268	RE525243	23	199	RE538097	24	177
RE521756	4	268	RE525802	1	247	RE538097	9	259
RE521756	5	268	RE526519	10	189	RE538123	2	199
RE521756	6	268	RE526519	8	271	RE538123	6	199
RE52242	7	208	RE526834	4	165	RE538806	4	156
RE52242	22	253	RE526834	2	205	RE538806	3	238
RE52242	7	282	RE526834	4	247	RE541322	1	367
RE522594	8	149	RE527018	1	156	RE54885	29	199
RE522594	34	231	RE527018	1	238	RE54885	17	317
RE522594	36	231	RE52702	14	353	RE55423	30	599
RE522594	5	306	RE52702	5	611	RE56098	24	321
RE522595	17	149	RE52702	40	675	RE56098	7	323
RE522596	36	149	RE52703	13	351	RE56369	12	167
RE522723	9	203	RE527054	32	149	RE56369	12	249
RE522794	10	203	RE527055	31	149	RE56859	41	675
RE522794	3	279	RE527098	4	175	RE57190	19	171
RE522823	8	203	RE527098	4	257	RE58664	15	63
RE522824	7	203	RE52722	2	203	RE58664	15	65
RE522827	24	197	RE52722	6	279	RE58664	14	67
RE522878	7	165	RE527528	17	149	RE58664	5	69
RE522878	7	247	RE527832	1	299	RE58664	3	71
RE523023	21	185	RE527833	1	297	RE58862	3	153
RE523023	21	267	RE527834	1	309	RE58862	3	235
RE523032	11	185	RE527858	21	199	RE59298	2	193
RE523032	11	267	RE527858	1	273	RE59298	2	275
RE523168	1	177	RE528089	23	199	RE60028	2	197
RE523168	2	177	RE528207	1	300	RE60030	16	197
RE523168	2	259	RE528219	7	199	RE60071	5	197
RE523169	10	177	RE528277	28	199	RE60700	41	839
RE523169	6	177	RE528638	1	179	RE60700	41	841
RE523169	7	177	RE528652	3	238	RE60700	34	843
RE523169	8	177	RE528734	4	153	RE60700	33	845
RE523169	9	177	RE528734	4	235	RE60701	14	665
RE523169	19	259	RE528884	1	199	RE60854	6	165
RE523249	13	149	RE528950	4	179	RE60854	8	247
RE523250	17	171	RE528950	4	261	RE63674	13	179
RE523250	16	253	RE529641	1	205	RE63674	22	261
RE523251	8	153	RE529643	5	205	RE65165	7	180
RE523251	8	235	RE529804	7	206	RE65165	7	262
RE523319	4	199	RE530613	4	183	RE65165	1	286
RE523462	4	197	RE530616	1	183	RE65168	4	180
RE523464	1	197	RE530616	2	183	RE65168	4	262
RE523483	27	211	RE530616	5	183	RE65168	1	287
RE523491	9	199	RE531221	13	189	RE65908	11	183
RE523553	10	211	RE531221	14	271	RE65908	11	265
RE523554	21	211	RE531223	7	271	RE65908	1	284
RE523617	23	211	RE531808	35	497	RE65909	11	183
RE523629	10	197	RE532250	18	149	RE65909	11	265
RE523819	1	199	RE533148	1	185	RE65909	1	285
RE523819	6	199	RE533148	5	185	RE65911	7	180
RE523854	11	203	RE533148	1	267	RE65911	7	262
RE523854	1	279	RE533148	5	267	RE65911	1	288
RE524220	11	197	RE533505	34	231	RE65912	4	180
RE524382	5	149	RE533505	1	306	RE65912	4	262
RE524382	9	149	RE533508	7	231	RE65912	1	289
RE524450	1	265	RE534109	18	149	RE65978	30	199
RE524450	2	265	RE534109	1	301	RE65978	25	211
RE524450	5	265	RE534110	18	149	RE66334	1	250
RE524450	1	295	RE534111	34	231	RE67231	1	193
RE524453	4	265	RE534111	1	306	RE67231	1	275
RE524453	3	295	RE534166	5	231	RE67238	1	144
RE524453	1	304	RE534167	4	231	RE67238	10	193
RE524528	9	231	RE534168	3	231	RE67238	2	208
RE52454	31	599	RE534188	24	231	RE67238	1	226
RE524676	3	313	RE534189	25	231	RE67238	9	275
RE524723	3	165	RE534333	21	231	RE67238	2	282
RE524730	6	206	RE534520	1	199	RE67240	4	144
RE524754	10	153	RE534545	1	199	RE68255	14	351
RE524754	4	153	RE534545	6	199	RE68255	12	353
RE524754	10	235	RE534733	8	231	RE68323	21	433
RE524754	4	235	RE534826	33	375	RE69243	2	173
RE524901	32	199	RE535686	1	199	RE69243	2	255
RE525016	4	279	RE535686	6	199	RE70678	4	162
RE525016	31	475	RE535729	6	211	RE70678	4	244
RE525016	33	477	RE535990	1	199	RE70682	5	162
RE525016	35	479	RE535990	2	199	RE70682	5	244
RE52504	37	371	RE535990	6	199	RE70756	7	162
RE52504	7	373	RE536781	1	217	RE70756	7	244
RE52506	16	599	RE536781	19	365	RE71143	3	153
RE52507	10	599	RE536805	12	199	RE71143	3	235
RE52508	18	599	RE537143	18	211	RE71255	4	158

## Numerical Index - Continued

Part No.	Key	Page	Part No.	Key	Page	Part No.	Key	Page
T230794	35	677	T242088	15	817	T245365	9	719
T230819	13	419	T242088	13	823	T245365	26	733
T230819	6	421	T242089	16	569	T245365	25	759
T230849	10	541	T242089	16	811	T245365	21	913
T230849	10	549	T242089	20	813	T246236	1	465
T230850	18	407	T24210	47	675	T246237	3	465
T230879	19	627	T242247	11	757	T246238	2	465
T230882	1	553	T242388	20	567	T246238	10	473
T230884	2	553	T242388	19	569	T246608	7	623
T231038	29	435	T242388	18	571	T246682	3	621
T231231	3	623	T242406	12	99	T246687	2	621
T231584	14	419	T242411	24	759	T246891	44	435
T231584	7	421	T242436	6	117	T246892	22	425
T231585	1	429	T242439	9	117	T246892	44	435
T231593	15	425	T242441	8	101	T246893	24	423
T231594	17	423	T242442	20	103	T246893	44	435
T232264	1	621	T242443	21	103	T247034	45	435
T232266	12	621	T242445	22	103	T249265	2	543
T232291	10	621	T242446	21	103	T249266	3	543
T232292)	11	621	T242446	23	103	T25CA	2	685
T232552	13	613	T242448	24	111	T25EA	6	685
T233026	18	423	T242449	25	123	T250948	37	629
T233027	16	425	T242449	26	125	T251098	35	615
T233076	27	417	T242449	25	127	T251098	64	615
T234115	19	423	T242449	25	129	T251099	15	613
T234116	17	425	T242449	25	131	T251099	14	615
T234126	24	425	T242449	28	133	T251099	18	615
T234127	26	423	T242450	26	127	T251099	26	615
T234281	4	621	T242451	27	127	T251375	9	655
T234282	6	621	T242453	26	129	T251564	4	623
T234327	9	621	T242453	26	131	T251599	14	613
T234379	5	623	T242454	29	133	T251599	71	615
T234392	15	681	T242455	26	123	T251759	27	543
T234394	16	681	T242455	27	125	T252192	21	563
T234564	44	325	T242456	27	123	T252192	7	563
T234564	15	327	T242456	28	125	T252906	18	815
T234564	44	329	T242459	12	113	T252957	3	427
T234564	16	331	T242462	25	115	T253701	4	427
T234564	15	333	T242465	26	115	T254126	21	447
T23474	15	179	T242466	5	107	T254126	21	449
T23474	13	261	T242467	9	97	T254126	22	451
T234768	39	479	T242677	44	371	T254126	22	453
T235477	15	563	T242677	11	373	T254266	13	469
T236611	30	729	T242809	39	595	T254267	14	469
T236612	29	729	T242832	40	595	T254370	5	427
T236883	16	563	T242935	21	415	T254371	6	427
T237617	21	385	T242936	22	415	T254372	7	427
T237696	17	563	T242937	23	415	T254373	8	427
T238029	45	325	T242938	24	415	T254374	9	427
T238029	54	327	T242939	25	415	T254375	10	427
T238029	45	329	T242940	26	415	T254376	24	427
T238029	57	331	T243048	21	423	T254378	11	427
T238029	54	333	T243049	19	425	T254379	12	427
T238029	45	675	T244710	23	545	T254380	13	427
T238029	26	807	T244711	10	543	T254381	14	427
T238029	29	809	T244712	2	545	T254382	15	427
T238029	6	873	T244713	17	543	T254383	16	427
T238029	6	875	T244714	17	545	T254385	17	427
T238029	7	877	T244715	8	545	T254386	18	427
T238611	12	611	T244716	7	545	T254387	19	427
T238657	39	321	T244717	13	543	T254388	23	427
T238657	3	323	T244720	12	543	T254389	20	427
T23914	6	441	T244723	15	539	T254390	21	427
T239251	18	563	T244724	14	543	T254495	3	317
T239329	14	591	T244758	39	607	T254524	25	427
T239330	22	591	T244935	1	529	T254778	38	321
T239559	22	385	T244936	2	529	T254778	1	323
T239722	5	519	T244938	3	529	T254813	7	635
T240085	46	675	T244939	4	529	T254813	7	639
T240315	28	417	T245139	23	605	T254887	29	417
T240371	11	541	T245139	40	607	T255100	31	417
T240371	11	549	T245140	24	605	T255101	24	425
T240636	18	425	T245140	41	607	T255102	26	423
T240637	20	423	T245141	25	605	T255630	26	317
T240908	19	563	T245141	42	607	T255730	30	417
T241042	23	385	T245149	22	423	T255964	11	473
T241092	5	33	T245150	20	425	T256003	28	543
T241133	19	621	T245151	23	423	T256253	6	673
T241135	18	621	T245152	21	425	T257359	44	317
T241167	12	541	T245259	5	529	T257744	2	317
T241167	12	549	T245262	43	607	T257979	9	923
T241899	20	563	T245279	6	623	T258411	23	425
T242088	16	567	T245321	13	541	T258412	25	423

CLICK HERE TO **DOWNLOAD** THE COMPLETE MANUAL

- Thank you very much for reading the preview of the manual.
- You can download the complete manual from: [www.heydownloads.com](http://www.heydownloads.com) by clicking the link below



- Please note: If there is no response to CLICKING the link, please download this PDF first and then click on it.

CLICK HERE TO **DOWNLOAD** THE COMPLETE MANUAL