

en

Operator's manual

Material handling machine

Document ID

	ORIGINAL OPERATOR'S MANUAL
Order number:	12214854
Issued:	2020-08-31
Version:	01
Author:	LHB / Technical Documentation Department

Product ID

Manufacturer:	Liebherr-Hydraulikbagger GmbH
Type:	LH 60 M Timber Litronic
Type no.:	1475 (USA / CAN)
From Serial no.:	82117

Contact

Liebherr-Hydraulikbagger GmbH
Liebherrstraße 12
D – 88457 Kirchdorf/Iller

CLICK HERE TO **DOWNLOAD** THE COMPLETE MANUAL

- Thank you very much for reading the preview of the manual.
- You can download the complete manual from: www.heydownloads.com by clicking the link below



- Please note: If there is no response to CLICKING the link, please download this PDF first and then click on it.

CLICK HERE TO **DOWNLOAD** THE COMPLETE MANUAL

3.3.8	Safety belt	133
3.3.9	Steering wheel	134
3.3.10	Ignition key	135
3.3.11	Confirmation button	135
3.3.12	Horn	136
3.3.13	Windscreen	137
3.3.14	Sun blind	139
3.3.15	Viewing devices	140
3.3.16	Lighting	142
3.3.17	Cab lighting system	143
3.3.18	Beacon (option)	144
3.3.19	Windscreen wipers	145
3.3.20	Windscreen washer system	145
3.3.21	Auxiliary heater (option)	146
3.3.22	LiDAT (option)	146
3.4	Operation	147
3.4.1	Inspection tour before putting into service	147
3.4.2	Refuelling	148
3.4.3	Refuelling with electric refuelling pump (option)	148
3.4.4	Filling with diesel exhaust fluid	150
3.4.5	Preheating system for fuels and operating fluids (option)	151
3.4.6	Immobiliser (option)	153
3.4.7	Preparing machine for dust intensive application	154
3.4.8	Preparing machine for use in biologically sensitive areas	155
3.4.9	Operator code (option)	155
3.4.10	Starting diesel engine	156
3.4.11	Bringing machine to operating temperature	157
3.4.12	Engine speed and operating mode	157
3.4.13	After starting	159
3.4.14	Sensor-controlled low idle automatic	160
3.4.15	Automatic engine stop after idling (option)	160
3.4.16	Shutting off diesel engine	161
3.4.17	Shutting off diesel engine in an emergency	161
3.4.18	Travelling and braking	162
3.4.19	Automatic service brake (option)	165

1.2 Technical data

1.2.1 Vibration emission

Designation	Unit	Value
Hand/arm vibrations	m/s ²	≤ 2.5
Whole-body vibrations	m/s ²	≤ 0.5

Tab. 1: Vibration emission

Operator's seat

- The operator's seat built into this machine by the manufacturer conforms to ISO 7096:2000, EM 6.

Hand/arm vibrations

- If the machine is operated as intended, the weighted (frequency-weighted) effective value of the hand/arm vibrations in accordance with ISO 5349- 1:2001 is less than 8.2 ft/s².

Whole-body vibrations

- This value conforms to the details of technical report ISO/TR 25398:2006.
- The measuring inaccuracy is defined in standard EN 12096:1997.
- As the specified values are individual effective values for specific typical application areas, only a limited assessment of the load imposed on the operator by whole-body vibrations is possible.

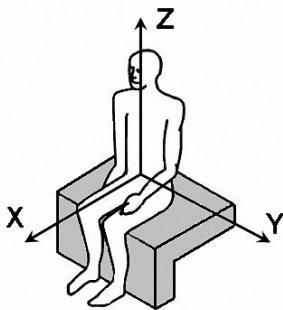

1.2.2 CO₂ emissions of diesel engine

NOTICE

Incorrect operation!
High emission values.

- ▶ Operate and service diesel engine and exhaust treatment system according to operator's manual.

Choice of Cab Elevation

Cab Elevation LFC (Rigid Elevation)

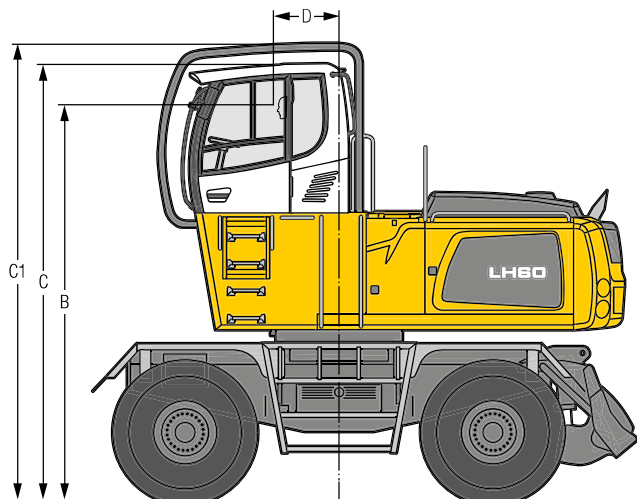

Increase type	LFC 120
Height	3'11"
B	15' 2"
C	16' 9"
C1	17' 6"
D	2' 6"

A rigid cab elevation has a fixed eye level height. For a lower transport height, the shell of the cab can be removed and replaced by a transport device. On this machine dimension C is 13'10".

Cab Protection

Integral Guard

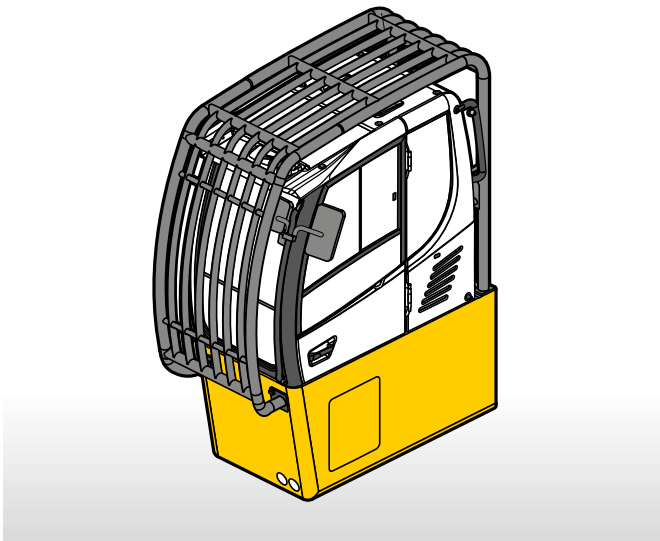

Environmental pollution

Unapproved disposal of machine

- Make sure that the individual elements of the machine are disposed of correctly after the service life.
- Dispose of elements of machine in line with valid country-specific waste disposal guidelines and relevant valid laws.
- Remove fuels, operating fluids and lubricants from all components before disposal.
- Collect and store fuels, operating fluids and lubricants in suitable containers before disposal.
- Adhere to instructions of relevant manufacturer when disposing of fuels, operating fluids and lubricants.
- Have fuels, operating fluids and lubricants disposed of by old oil recycling point.
- Have metal parts disposed of by metal recycling point.
- Have plastic parts disposed of by plastic recycling point.
- Have rubber parts disposed of by rubber recycling point.
- Have electronic components disposed of by electronics recycling point.

2.3 Description of staff

2.3.1 Personal protective equipment

Operators, assistants and maintenance staff are responsible for the following:

- Wearing personal protective equipment
- Regular cleaning and care of protective equipment
- Immediate replacement of damaged parts of protective equipment



The protective equipment consists of following elements:

- Protective helmet
- Safety glasses
- Hearing protection
- Breathing equipment
- Protective gloves
- Warning clothing (reflective, in signal colour)
- Safety boots
- Special protective clothing
 - To prevent burns
 - To prevent freezing
 - To prevent acid burns
 - To prevent stabbing and cutting injuries

2.3.2 Requirements for staff

Staff meet the following requirements:

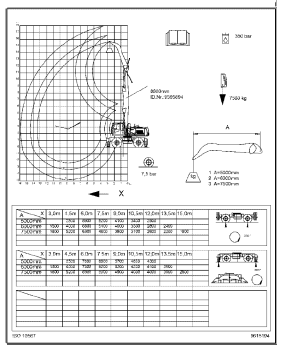
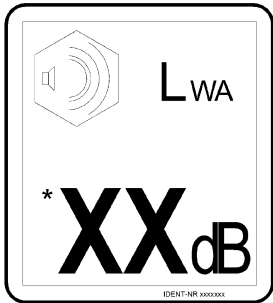
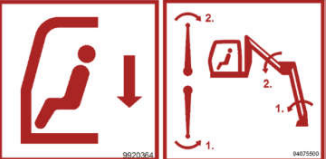
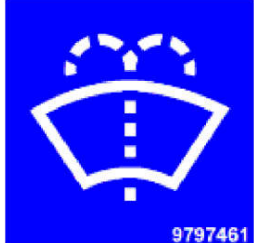
- The machine is operated, maintained and repaired exclusively by authorised and trained persons.
- All persons operating, maintaining or repairing the machine have the required minimum age.
- Staff training involves theoretical information (technology and safety) and practical training on the machine.

Sign	Description
	<p>Load lift chart Indicates approved load capacities at the end of the stick in dependence on the reach.</p>
	<p>Sound power level L_{WA} Shows sound power level of the machine in dB(A).</p>
	<p>Emergency lowering of the operator's cab Applies to machines with height adjustable cab. Identifies location of emergency lowering. Identifies position of the levers for emergency lowering of the operator's cab.</p>
	<p>Windscreen washer tank Indicates filler pipe for windscreen washer fluid.</p>
	<p>Coolant Identifies prescribed coolant. Read notes in operator's manual.</p>
	<p>Hydraulic oil Identifies prescribed hydraulic oil. Read notes in operator's manual.</p>

LHB/12214854/01/2020-08-31/en

2.7.5 Machine danger zone

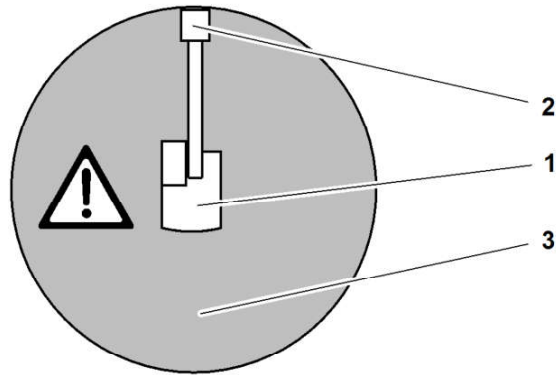

Fig. 60: Machine danger zone (view from above)

- | | | | |
|---|-----------------------------|---|-------------|
| 1 | Machine | 3 | Danger zone |
| 2 | Reach of working attachment | | |

Danger to life

Unapproved presence in danger zone

- Make sure there are no persons in danger zone.

2.7.6 Visibility

Danger to life

Insufficient visibility

- Make sure that persons approach machine from the front and within operator's field of vision.
- Make sure that persons contact the operator before approaching the machine.
- Make sure that no obstacles impair visibility in the working area.
- Use viewing devices to observe environment of machine if necessary.
- Use viewing devices if necessary to observe areas around the machine that cannot be seen directly.
- Exclusively perform rotary motions if visibility is sufficient.
- Position working attachment so that sufficient visibility is ensured.
- Avoid travelling in reverse whenever possible.
- Work with spotter if visibility is restricted.
- Agree on which hand signs to use.
- If necessary communicate via radio.
- Make sure that spotter is outside danger zone.
- In conditions of poor visibility use illumination in accordance with the applicable regulations.
- Exclusively use sun visors if field of vision is not restricted.

Incorrect operation

- Comply with national regulations regarding sufficient visibility in the operator's cab.

- | | | | |
|----|---|----|--------------------------------------|
| 12 | Control, magnetic crossbeam ²⁾ | 29 | Unlocking button for folding console |
| 13 | Right joystick | 30 | Left joystick |
| 14 | Control unit B | 31 | Console lever |
| 15 | Ignition key | 32 | Safety barrier |
| 16 | Engine speed controller | 33 | Double pedal ²⁾ |
| 17 | Control unit C | | |

3.1.2 Control unit A

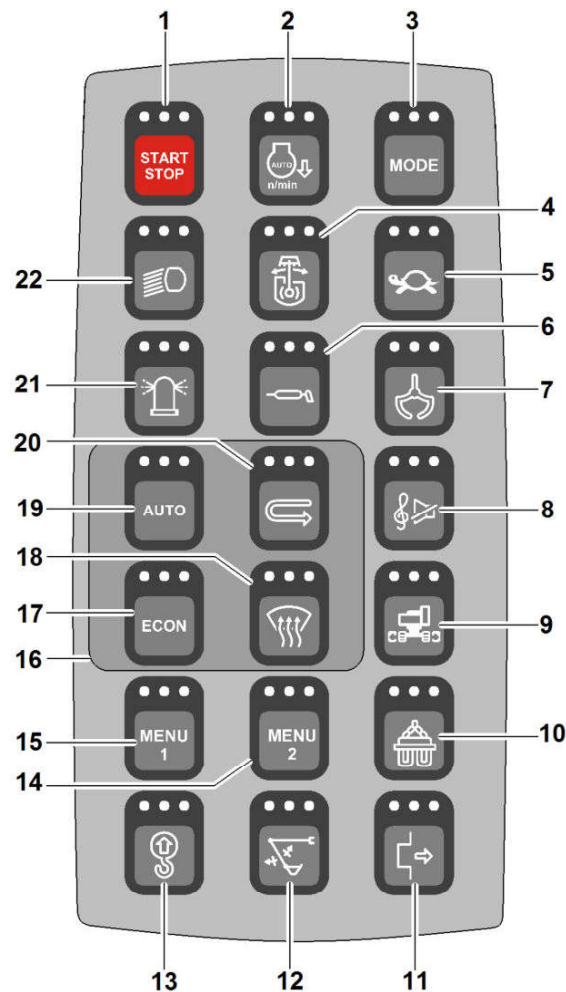

Fig. 62: Control unit A

- | | | | |
|---|--|----|---------------------------------------|
| 1 | Engine start/stop key | 12 | Bypassing stick cylinder shut-off key |
| 2 | Sensor-controlled low idle automatic key | 13 | Overload warning system key (option) |
| 3 | MODE key (option) | 14 | Menu 2 key |
| 4 | Slewing brake key | 15 | Menu 1 key |

See next page for continuation of the image legend

²⁾ Option

3.2 Display

3.2.1 Display

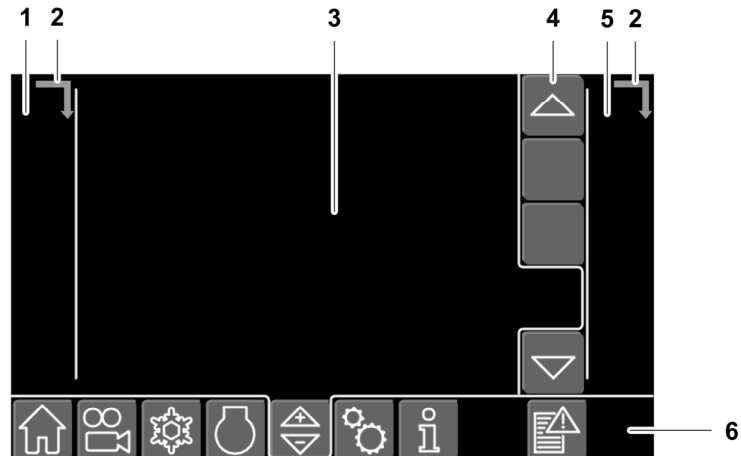

Fig. 216: Display

- | | | | |
|---|-----------------------|---|-------------|
| 1 | Status bar | 4 | Submenu bar |
| 2 | Further symbols arrow | 5 | Warning bar |
| 3 | Display field | 6 | Menu bar |



Note





The arrow indicates that further symbols are available in the status bar or warning bar on the display.

The symbols are displayed alternately under the *Further symbols* arrow 2.









Fig. 217: Symbols with a grey background are buttons

- | | | | |
|---|--------|---|--------|
| 1 | Symbol | 2 | Button |
|---|--------|---|--------|

Symbol	Meaning
	Hoist cylinder has reached maximum.
	Hoist cylinder has reached minimum.
	Stick cylinder has reached maximum.
	Stick cylinder has reached minimum.
	Automatic mode locked

Tab. 25: Status symbols of height-adjustable cab

Diesel engine

Symbol	Meaning
	Power reduction of diesel engine
	Power reduction of diesel engine
	Automatic engine stop
	Automatic engine stop blocked
	Delayed engine stop active or Automatic engine stop before long
	Engine start blocked
	Engine stop blocked

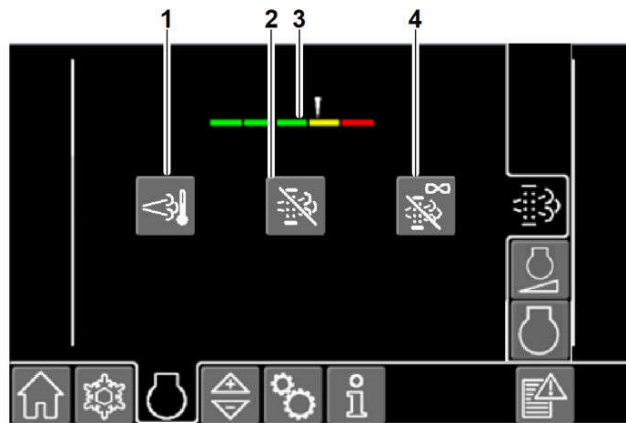

Fig. 388: Diesel particulate filter submenu

- | | | | |
|---|--------------------------------|---|--|
| 1 | Activating regeneration button | 3 | Contamination level |
| 2 | Blocking regeneration button | 4 | Blocking regeneration permanently button |

The regeneration can be activated or blocked depending on contamination level of the diesel particulate filter. (For more information see: [5.8.9 Diesel particulate filter: Activating and deactivating regeneration](#), page 323)

3.2.8 Sensor-controlled low idle automatic and automatic engine stop submenu (option)

Menu call:  > 

The display of this submenu varies depending on machine configuration:

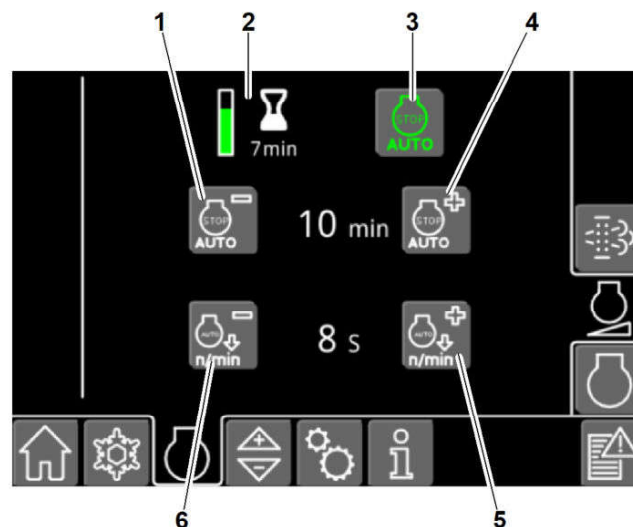

Fig. 389: Sensor-controlled low idle automatic and automatic engine stop submenu

- | | | | |
|---|---|---|---|
| 1 | Reducing idling time until automatic engine stop button | 4 | Increasing idling time until automatic engine stop button |
|---|---|---|---|

See next page for continuation of the image legend

3.2.24 *Electrical inputs* submenu

Menu call:  >  > 

The display of this submenu varies depending on machine configuration:

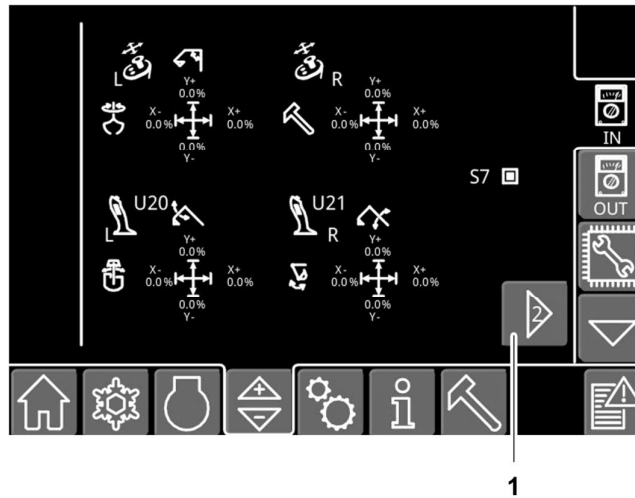



Fig. 419: *Electrical inputs* submenu

1 Scroll button

The *electrical inputs* submenu provides a quick overview for Liebherr customer service. It shows the operating status of the electrical inputs.

3.2.25 *Function settings* menu

Menu call: 

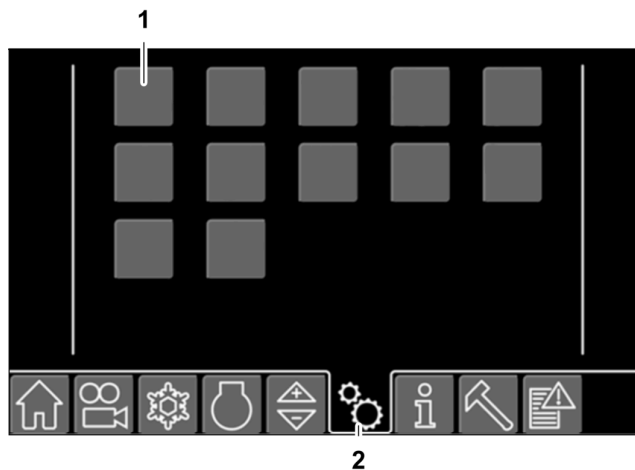

Fig. 420: *Function settings* menu

1 Menu buttons

2 *Function settings* menu

Quantity of menu buttons on the display depends on machine type and equipment.

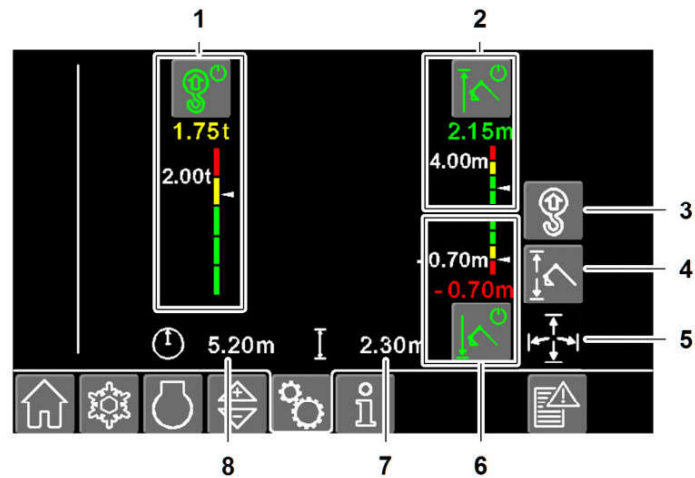

Fig. 457: Workspace limitation submenu

- | | | | |
|---|--|---|----------------------------------|
| 1 | Load moment limitation | 5 | Workspace limitation menu button |
| 2 | Height limitation | 6 | Depth limitation |
| 3 | Load moment limitation menu button | 7 | Height of loading point |
| 4 | Height limitation and depth limitation menu button | 8 | Reach of loading point |

▶ Activate load moment limitation: (For more information see: [3.5.6 Load moment limitation \(option\)](#), page 212)

▶ Activate height limitation:

▶ Activate depth limitation: (For more information see: [3.5.4 Depth limitation \(option\)](#), page 202)

3.2.35 Automatic reversible fan drive submenu (option)

Menu call:  > 

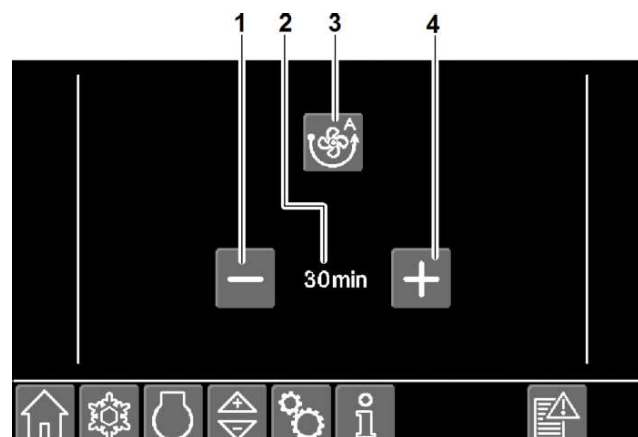

Fig. 458: Automatic reversible fan drive submenu

- | | | | |
|---|-------------------------------|---|---------------------------------------|
| 1 | Reducing time interval button | 3 | Automatic reversible fan drive button |
|---|-------------------------------|---|---------------------------------------|

[See next page for continuation of the image legend](#)

3.3.4 Emergency exit



Fig. 483: Information sign: emergency exit / emergency hammer

An information sign on the rear window identifies the rear of the operator's cab as the emergency exit. The emergency hammer is located next to the cab door under the cab roof.

- ▶ In an emergency, break the rear window with the emergency hammer.

3.3.5 Fire extinguisher (option)



DANGER

Incorrect use of fire extinguisher!
Danger to life.

- ▶ Use fire extinguisher exclusively to extinguish blocked escape routes.
- ▶ Do not use fire extinguisher on electrical systems exceeding 1000 V.
- ▶ Adhere to instructions on fire extinguisher.

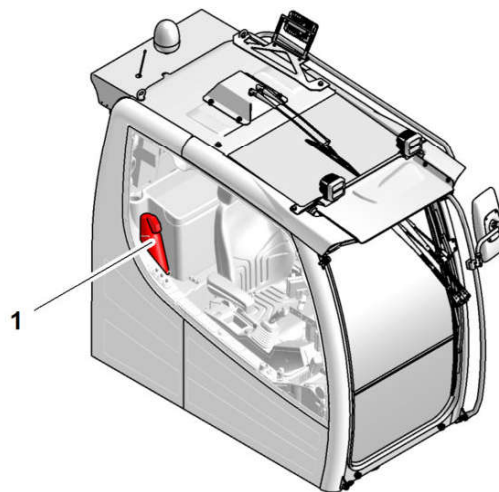

Fig. 484: Fire extinguisher

- 1 Fire extinguisher

Switching seat heating with seat air conditioning on and off (option)

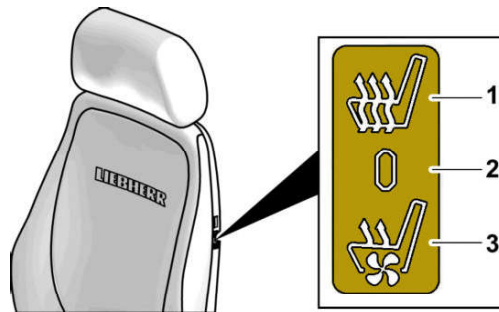

Fig. 504: Seat heating with seat air conditioning

- | | | | |
|---|---|---|---------------------------------|
| 1 | Switch on seat heating | 3 | Switch on seat air conditioning |
| 2 | Switch off seat heating and seat air conditioning | | |

3.3.8 Safety belt

The safety belt is an automatic safety belt. It does not need to be adjusted.

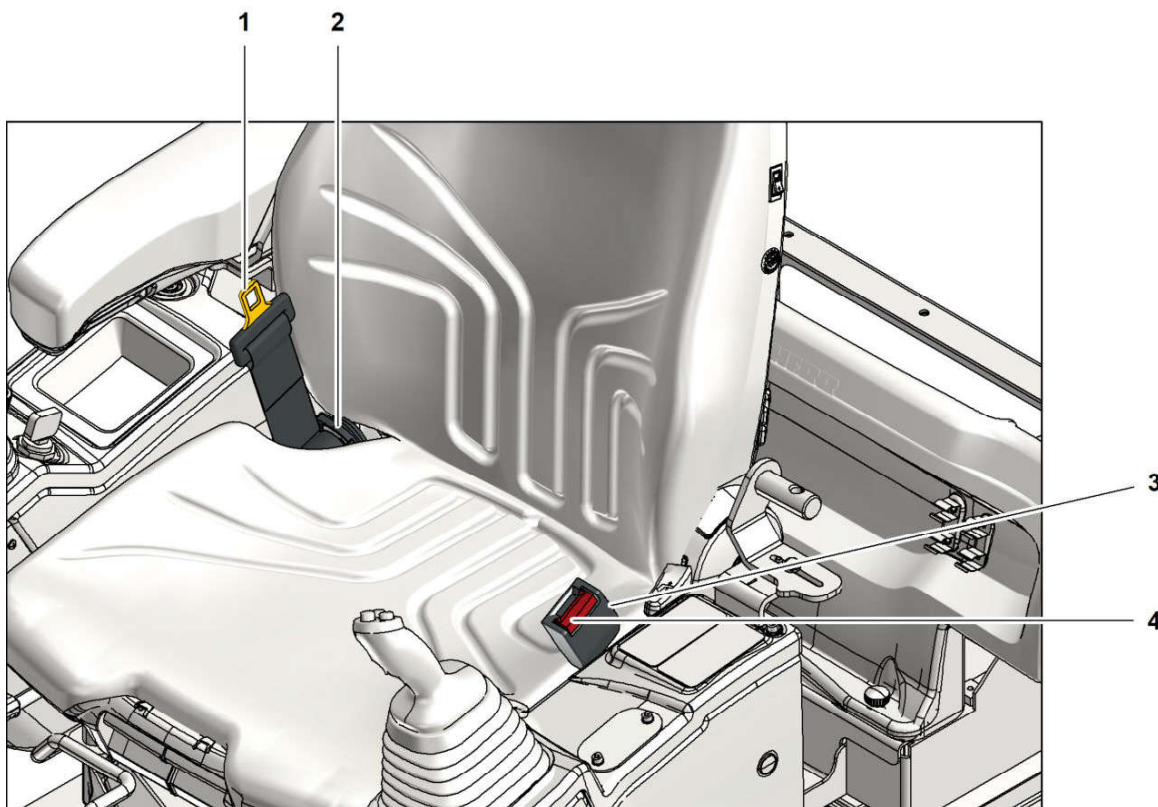



Fig. 505: Safety belt

- | | | | |
|---|-------------------|---|------------------|
| 1 | Belt buckle latch | 3 | Belt buckle |
| 2 | Belt reel | 4 | Unlocking button |

Beacon (option)

Key	Status of LEDs	Function
	○ ○ ○	Beacon switched off
	● ● ●	Beacon switched on

Tab. 45: Beacon

- ▶ Switch on and switch off beacon: Press *beacon* key.

3.3.17 Cab lighting system

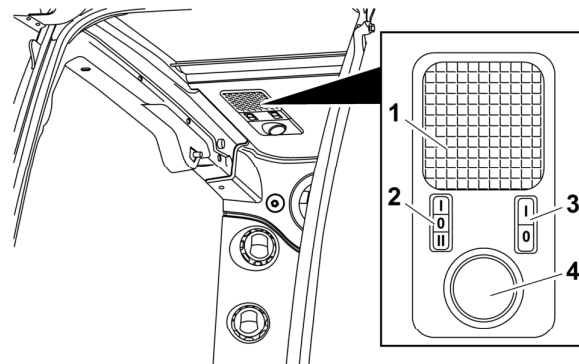

Fig. 543: Cab lighting system

- | | | | |
|---|--------------------------------|---|-------------------------|
| 1 | Cab lighting system | 3 | Switch for reading lamp |
| 2 | Switch for cab lighting system | 4 | Reading lamp |



Note

Discharged battery.

- ▶ Make sure that cab lighting system is switched off when exiting machine.

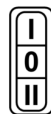

Cab lighting system

- ▶ Make sure that ignition key is set to 1.
- ▶ Switch on cab lighting system: Set switch for cab lighting system 2 to I.
- ▶ Switch off cab lighting system: Set switch for cab lighting system 2 to 0.



Cab lighting system for entry and exit

The cab lighting system for entry and exit is independent of the position of the ignition key.

Button	Status of LEDs	Travel speed
		First gear: Low travel speed
		Second gear: High travel speed

Tab. 51: Gear step key

Selecting creeper gear

Creeper gear has following properties:



- Sensitive driving at low speeds
- Improved driving behaviour on inclines and difficult terrain



WARNING

Braking too hard and abruptly!
Injuries.

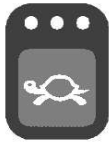
- ▶ Switch to creeper gear exclusively if machine is stationary.

Button	Status of LEDs	Travel speed
		Normal travel
		Creeper gear

Tab. 52: Creeper gear key

Travelling

Steering variants of machine:

- Steering wheel steering
- Joystick steering

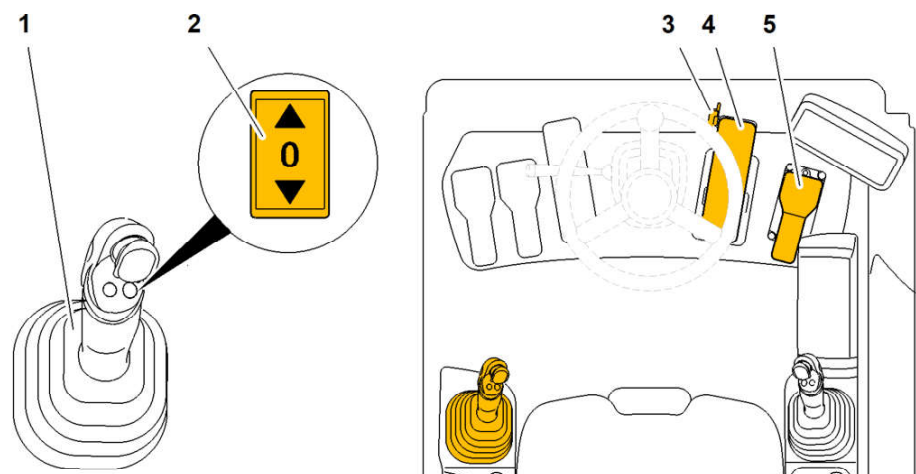

Fig. 603: Example position of control elements

- | | |
|---------------------------|--------------------------|
| 1 Joystick | 4 Pedal of service brake |
| 2 Travel direction switch | 5 Accelerator pedal |
| 3 Retainer | |

LHB/1221485/01/2020-08-31/en

CLICK HERE TO **DOWNLOAD** THE COMPLETE MANUAL

- Thank you very much for reading the preview of the manual.
- You can download the complete manual from: www.heydownloads.com by clicking the link below



- Please note: If there is no response to CLICKING the link, please download this PDF first and then click on it.

CLICK HERE TO **DOWNLOAD** THE COMPLETE MANUAL

3.4.25 Supporting machine

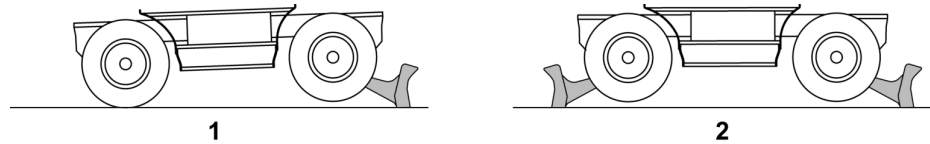

Fig. 647: Support variants

1 Rear support blade

2 Rear and front support blade



DANGER

Machine tipping over!

Danger to life.

- ▶ Make sure that ground is sufficiently stable.
- ▶ Make sure that support is fully in contact with solid, non-slip and level ground.
- ▶ Make sure that support is not fully extended.
- ▶ Make sure that wheels do not have ground contact.



Note

Different machine configuration.

- ▶ Adhere to control description sticker in operator's cab.

Depending on the equipment the support is moved with one of the following control elements:

- Left mini-joystick 1
- Support adjusting lever 2

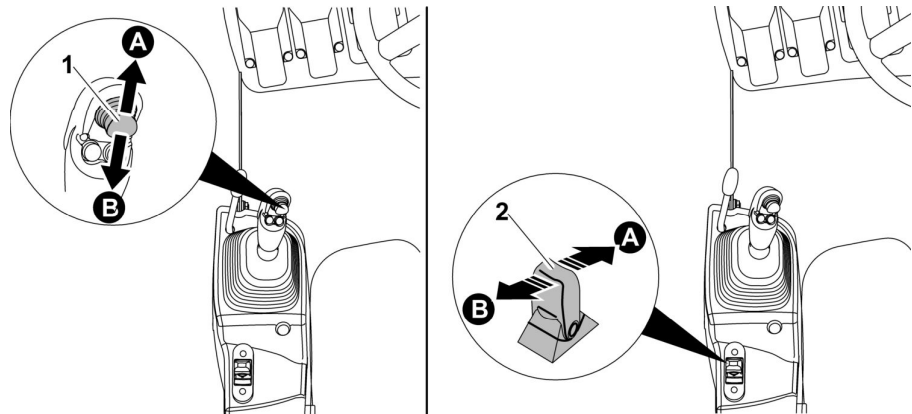



Fig. 648: Control elements





1 Left mini-joystick

2 Support adjusting lever

Status symbol	Meaning
	Reversible fan drive blocked: Time distance for repeated switching on is too short.
	Reversible fan drive blocked: Coolant temperature is too high.

Tab. 63: Reversible fan drive blocked status symbol

Switching on reversible fan drive manually

Key	Status of LEDs	Function
		Fan changes from normal mode to stationary.
		Fan turns in opposite direction of rotation.
		Fan changes from opposite direction of rotation to stationary.

Tab. 64: Switching on reversible fan drive manually

► Make sure that air intake area is free from persistent soiling.

Automatic reversible fan drive (option)

Menu call:  > 

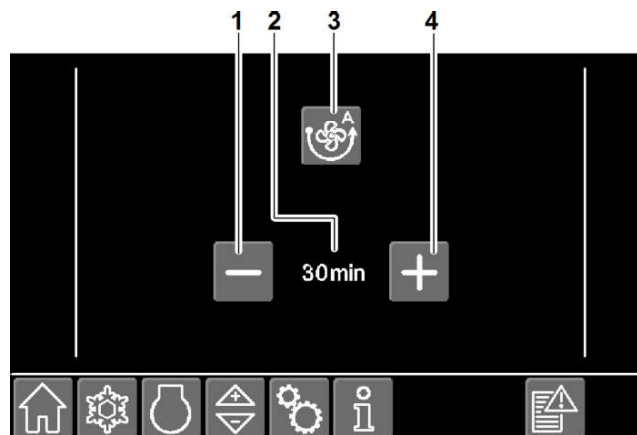

Fig. 690: Automatic reversible fan drive menu

- | | |
|---------------------------------|---|
| 1 Reducing time interval button | 3 Automatic reversible fan drive button |
| 2 Set time interval | 4 Increasing time interval button |

LHB/12214854/01/2020-08-31/en

- ▶ Turn key to right into enabled position for authorisation.
- ▶ Press *height limitation* button.
- ▶ Press confirmation button.
 - ▷ *Height limitation* button lights up white:



- ▶ Turn key to left for authorisation.

Switching on height limitation

Make sure the following precondition is met:

- Settings for height limitation are enabled.
- ▶ Press *height limitation* button.
- ▶ Press confirmation button.
 - ▷ *Height limitation* button lights up green:



Switching off height limitation

Make sure the following precondition is met:

- Settings for height limitation are enabled.
- ▶ Press *height limitation* button.
- ▶ Press confirmation button.
 - ▷ *Height limitation* button lights up white:



Locking settings for height limitation



Note

After height limitation is locked, switched-on load moment limitation is locked.

- ▶ Make sure that load moment limitation is switched off.



Note

After height limitation is locked, switched-on slew limitation is locked.

- ▶ Make sure that slew limitation is switched off.



Note

After height limitation is locked, switched-on virtual wall is locked.

- ▶ Make sure that virtual wall is switched off.

A supervisor is authorised to lock following settings for the operator:

- Switch off height limitation.

- ▶ Press confirmation button.
 - ▷ *Depth limitation* button lights up white:



- ▶ Turn key to left for authorisation.

Switching on depth limitation

Make sure the following precondition is met:

- Settings for depth limitation are enabled.
- ▶ Press *depth limitation* button.
- ▶ Press confirmation button.
 - ▷ *Depth limitation* button lights up green:



Switching off depth limitation

Make sure the following precondition is met:

- Settings for depth limitation are enabled.
- ▶ Press *depth limitation* button.
- ▶ Press confirmation button.
 - ▷ *Depth limitation* button lights up white:



Locking settings for depth limitation



Note

After depth limitation is locked, switched-on load moment limitation is locked.

- ▶ Make sure that load moment limitation is switched off.



Note

After depth limitation is locked, settings for switched-on slew limitation are locked.

- ▶ Make sure that slew limitation is switched off.

A supervisor is authorised to lock following settings for the operator:

- Switch off depth limitation.
- Change maximum working depth.

Make sure the following precondition is met:

- Supervisor is present with authorisation key.
- ▶ Turn key to right into enabled position for authorisation.
- ▶ Press *depth limitation* button.
- ▶ Press confirmation button.



- ▶ Turn key to left for authorisation.

Switching on load moment limitation

If activated, load moment limitation is switched on when machine is started again. The signal lamp lights up.



DANGER

Machine tipping over!
Danger to life.

- ▶ Make sure that oscillating axle is locked.

Make sure the following preconditions are met:

- Load moment limitation is enabled.

Switching on load moment limitation using the display

- ▶ Press *load moment limitation* button 5.
- ▶ Press confirmation button.
 - ▷ LEDs in *load moment limitation* key on control unit A light up.
 - ▷ *Load moment limitation* button lights up green:

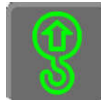

- ▷ Warning buzzer sounds briefly.
- ▷ Signal lamp lights up.

Switching on load moment limitation using control unit A



- ▶ Press *load moment limitation* key on control unit A.
- ▶ Press confirmation button.
 - ▷ LEDs in *load moment limitation* key on control unit A light up.
 - ▷ *Load moment limitation* button lights up green:



- ▷ Warning buzzer sounds briefly.
- ▷ Signal lamp lights up.

Switching off load moment limitation

Make sure the following precondition is met:

- Load moment limitation is enabled.

Switching off load moment limitation using display

- ▶ Press *load moment limitation* button 5.
- ▶ Press confirmation button.
 - ▷ LEDs in *load moment limitation* key on control unit A go out.

3.6.6 Handling loads

Handling loads



DANGER

Machine tipping over!
Danger to life.

- ▶ Make sure there are no persons in hazard zone.
- ▶ Make sure that ground has sufficient load-bearing capacity.
- ▶ Carry out all movements steadily.
- ▶ Draw working attachment in close to machine and move load close to the ground.



WARNING

Incorrect handling of grapple!
Injuries.

- ▶ Make sure that grapple and load do not swing close to operator's cab.
 - ▶ Prevent grapple and load from swinging: Move joystick carefully and slowly.
-
- ▶ Adhere to load lift chart.
 - ▶ Carefully take up load.
 - ▶ Carefully swivel load over unloading point.
 - ▶ Put down load.
- or
- ▶ Empty grapple.

Travelling with load

- ▶ Observe instructions about travelling.
- ▶ Align uppercarriage parallel to undercarriage.

3.6.7 Loading transport vehicle



DANGER

Falling load!
Danger to life.

- ▶ Make sure there are no persons in danger zone.
- ▶ Make sure that there are no persons in transport vehicle.
- ▶ Do not slew working attachment over operator's cab of transport vehicle.

- | | | | |
|---|--------------------|---|--------------------------------|
| 4 | Pin | 9 | Connection for turning grapple |
| 5 | Grapple suspension | | |

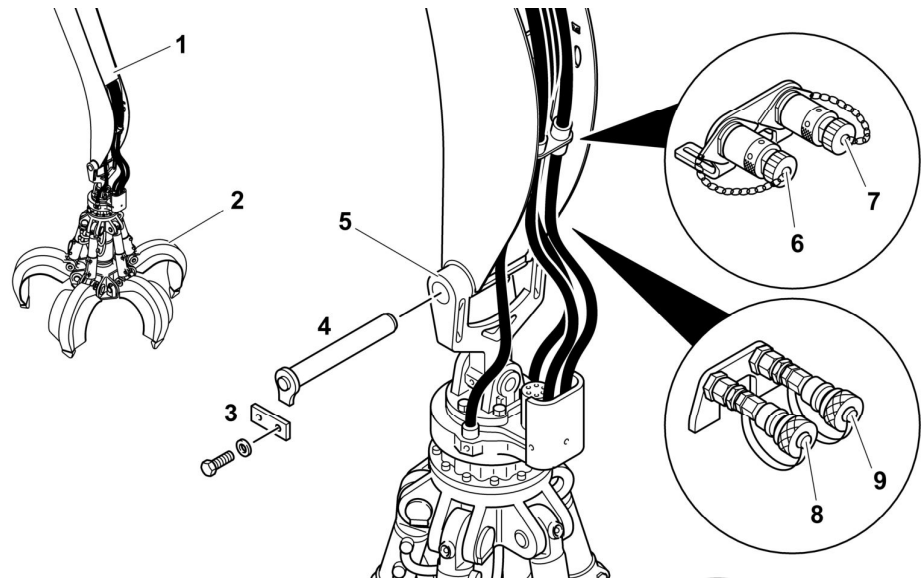

Fig. 844: Grapple on industrial stick, variant 2

- | | | | |
|---|--------------------|---|---|
| 1 | Stick | 6 | Connection for opening or closing grapple |
| 2 | Grapple | 7 | Connection for opening or closing grapple |
| 3 | Pin retention | 8 | Connection for turning grapple |
| 4 | Pin | 9 | Connection for turning grapple |
| 5 | Grapple suspension | | |

Installing grapple



CAUTION

Pressurised hydraulic lines!
Injuries.

- ▶ Before coupling and uncoupling depressurise hydraulic system.

NOTICE

Incorrect mixture of hydraulic oils!
Damage to hydraulic system.

- ▶ Do not mix hydraulic oils.

Make sure the following preconditions are met:

- Second person is available for support.
- Required hydraulic hoses for grapple operation are mounted on industrial stick.
- Tines of grapple are fully opened.
- Grapple stands safely on even surface.
- ▶ Depressurise hydraulic hoses. (For more information see: [5.10.1 Depressurising hydraulic system, page 333](#))
- ▶ Position bearings of industrial stick for grapple between bearings of grapple suspension.

Emergency lowering lever in operator's cab

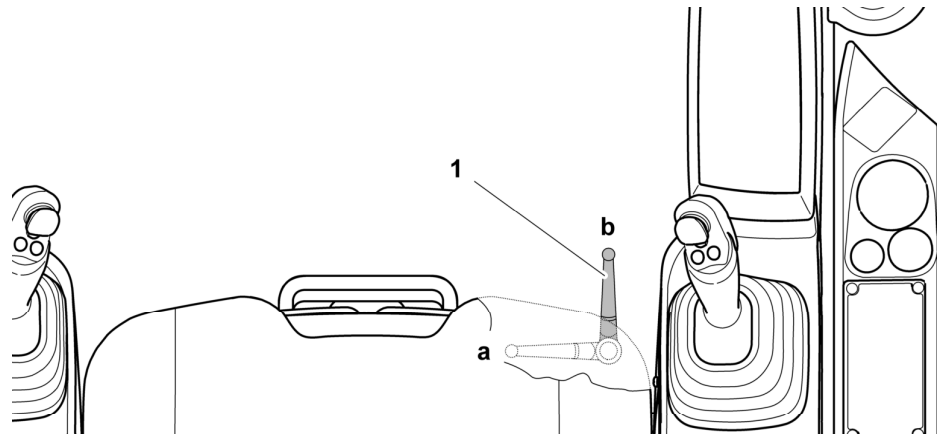

Fig. 854: Emergency lowering lever in operator's cab

- | | |
|---------------------------------------|--------------------------------------|
| 1 Emergency lowering lever | b Emergency lowering position |
| a Cab adjustment mode position | |

- ▶ Move emergency lowering lever **1** to emergency lowering position **b**.
 - ▷ Operator's cab is lowered.
- ▶ Stop lowering of operator's cab: Move emergency lowering lever **1** to cab adjustment mode position **a**.

Emergency lowering lever on pillar of cab lift frame

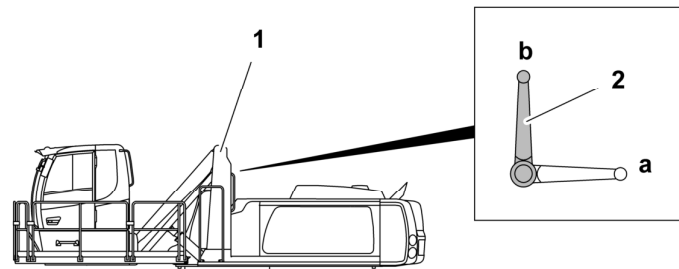

Fig. 855: Emergency lowering lever on pillar of cab lift frame

- | | |
|-----------------------------------|---------------------------------------|
| 1 Pillar of cab lift frame | a Cab adjustment mode position |
| 2 Emergency lowering lever | b Emergency lowering position |

- ▶ Move emergency lowering lever **2** to emergency lowering position **b**.
 - ▷ Operator's cab is lowered.
- ▶ Stop lowering of operator's cab: Move emergency lowering lever **2** to cab adjustment mode position **a**.

3.10.4 Towing the machine

The machine is not allowed to be towed.

If the machine has to be towed:

- ▶ Contact the Liebherr customer service.

Malfunction / error	Cause	Remedy
Diesel engine has difficulty starting.	Fuel low pressure circuit leaks or its pressure is too low.	Have leak test performed by Liebherr customer service.
	Diesel engine compression is too low.	Contact Liebherr customer service.
	Heating flange is defective (at cold temperatures).	Contact Liebherr customer service.
	Malfunction exists in electrical system.	Have error memory read by Liebherr customer service.
Diesel engine stops.	Power supply is interrupted.	Contact Liebherr customer service.
	Fuel low pressure circuit leaks or its pressure is too low.	Have leak test performed by Liebherr customer service.
Diesel engine performance too low (underperformance).	Fuel system is defective (clogged, leaking).	Performing visual inspection for leaks. Replace filter. Contact Liebherr customer service.
	Charging pressure is too low.	Tighten loose clamps. Replace defective seals and hoses. Clean air filter. Repair turbocharger.
	Charge air temperature is too high (automatic power reduction by engine control unit).	Clean intercooling air circuit. Lower ambient temperature. Contact Liebherr customer service.
	Fuel temperature is too high (automatic power reduction by engine control unit).	Contact Liebherr customer service.
	Coolant temperature is too high (automatic power reduction by engine control unit).	Check radiator for damage. Check fan and thermostat. Check coolant level. Contact Liebherr customer service.
	Area of deployment more than 5905' 6" ft-in above sea level.	No remedy
	Injectors get stuck or do not atomize.	Contact Liebherr customer service.
	Diesel engine compression is too low.	Contact Liebherr customer service.
	Malfunction exists in electrical system.	Contact Liebherr customer service.
	Exhaust -treatment system is clogged.	Contact Liebherr customer service.
Diesel engine has inadequate engine braking power.	Diesel engine brake flap not functional.	Contact Liebherr customer service.
	Malfunction exists in electrical system.	Contact Liebherr customer service.

LHB/12214854/01/2020-08-31/en

Fuse	Consumer	Rating [A]
F15	Supply voltage: B314 angular transmitter slip ring transmitter signal 2, B315 angle sensor swivel arm signal 1, B316 angle sensor boom signal 1, B317 angle sensor stick signal 1, B347 bucket cylinder lift or stick, B372 height-adjustable operator's cab down, B373 height-adjustable operator's cab up, socket monitoring	5
F16	Supply voltage: B1 tank sensor, B8 sensor hydraulic oil temperature, B14 sensor hydraulic oil level, B26 quick coupler proximity switch 1, B44 pressure switch air conditioning condenser, B53 speed sensor slewing gear, B314 angle sensor slip ring transmitter signal 1, B315 angle sensor swivel arm signal 2, B316 angle sensor boom signal 2, B317 angle sensor stick signal 2, B318 pressure sensor hoist cylinder, left, B319 pressure sensor hoist cylinder, right, B335 servo pressure slewing gear, B378 quick coupler proximity switch 2, B379 pressure sensor system pressure, pressure sensor hoist cylinder, reserve, cycle lubrication system	5
F17	Not occupied	15
F18	Not occupied	
F19	Fuel pre-heating	25
F20	Not occupied	

Tab. 100: Fuse strip A214.XF4

Fuse	Consumer	Rating [A]
F1	Not occupied	
F2	Not occupied	
F3	Operator's cab, terminal 15	50
F4	Heater flange	100
F5	Terminal 15	100
F6	Terminal 30	50
F7	Operator's cab, terminal 30	100

Tab. 101: Fuse strip A214.XF5

Relay	Consumer
K1	Terminal 15, safety lever or folding console
K2	Working headlight of working attachment
K3	Auxiliary heater
K4	Not used
K5	Step lighting
K6	Not used
K11	Counterweight working headlight
K12	Horn

Customer:..... Machine type:..... Serial no.:..... Operating hours:..... Date:.....

Maintenance / inspection after service hours							Tasks to be performed					
On handover	All 8-10 h	All 50 h	All 500 h	All 1000 h	All 2000 h	Other intervals	Additional labelling	By maintenance staff	By authorised specialist staff	Confirm tasks	See page	
								■ Once-only activity ● Repeat interval † If necessary ✱ Annually before the winter Additional labelling ††† Assistance required ‡ Have this task carried out exclusively by a certified electrician	□ Once-only activity ○ Repeat interval ✧ If necessary			
						✧		For machines for other emission stages: Diesel engine: Change oil. (at least once a year) (For more information see: Difficulty factors, page 286)				
						✧		Diesel engine: Replace oil filter. (at least during every engine oil change)				
						✧		Diesel engine: Replace oil separator filter cartridge. (at least during every engine oil change)				
			○	○	○			Diesel engine: Check belt drive.				
						○5000 h		Diesel engine: Replace belt.				
						○2000 h		Diesel engine: Check and adjust valve clearance.				
						✱		Diesel engine: Check heater flange.				
						○10000 h		Diesel engine: Replace heater flange.				
	●	●	○	○	○	†		Fuel pre-filter: Drain water.				315
		●	○	○	○			Fuel tank: Drain water and sediments.				316
				○	○	✧		Fuel pre-filter: Replace filter cartridge.				
				○	○	✧		Fuel fine filter: Replace filter element.				
						✧		Bleed fuel system.				
			○	○	○	✧		Air filter: Check contamination level.				
		●	○	○	○	†		Air filter: Empty dust collecting tank.				318
			○	○	○	†		Air filter: Replace main filter cartridge (when service indication appears / once a year).				319
				○		†		Air filter: Replace safety filter cartridge (on every third replacement of main filter cartridge / once a year).				321
		●	○	○	○			Pump distributor gear: Check oil level.				322
			○	○	○			Pump distributor gear: Change oil.				
						†		Diesel particulate filter: Activate and deactivate regeneration.				323
						✧		Diesel particulate filter: Replace filter module and send used filter module to authorised Liebherr service partner for cleaning.				
						○5000 h		Diesel particulate filter: Replace filter module and send used filter module to authorised Liebherr service partner for cleaning.				
						✧		Diesel exhaust fluid tank: Clean sieve.				
Cooling system												
	●	●	○	○	○	†		Check coolant level.				330
□	●	●	○	○	○	†		Check cooling system and heat exchanger for contamination.				331

LHB/12214854/01/2020-08-31/en

5.3 Fuels, lubricants and operating fluids

5.3.1 General information about lubricants and fuels

General questions

General questions can be addressed to the Liebherr Lubricant Hotline via email.

Liebherr Lubricant Hotline (email): <https://lubricants.liebherr.com>

Safety data sheets

Safety data sheets for lubricants and fuels are available online from the Liebherr lubricants portal.

Liebherr lubricants portal: <https://lubricants.liebherr.com>

Technical data sheets

Technical data sheets for lubricants and fuels are available online from the Liebherr lubricants portal.

One-time registration is required in order to access technical data sheets.

Liebherr lubricants portal: <https://lubricants.liebherr.com>

Specific Liebherr standards

Specific Liebherr standards for lubricants and fuels are available from the technical customer service at the relevant manufacturing plant.

5.3.2 Diesel fuels

Liebherr recommendation

Approved diesel fuels in line with DIN EN 590, ASTM D 975 1–D/2–D	Diesel engine stage V	Diesel engine stage IV or Tier 4f	Power band I/H as per Regulation ECE-R.96 (stage 3A, TIER III, CHINA III equivalent)
Maximum sulphur content	Up to 10 ppm	Up to 15 ppm	Up to 5000 ppm ²⁷⁾
Lubrication properties at 140 °F	15.75 th	18.11 th	
Minimum cetane number	45	45	

Tab. 110: Minimum quality requirements

Do not mix diesel fuel with fuel additives.

²⁷⁾ The sulphur content in the fuel determines the change interval in dependence on the quality of the engine oil.

Ambient temperature	Description
23 to 122 °F	Liebherr Gear Hypoid 90 EP
-4 to 122 °F	Liebherr Syntogear Plus 75W-90

Tab. 140: Liebherr recommendation

Minimum quality requirements

Specification
API: GL-5
MIL-L: 2105 D or E, PRF-2105 D or E

Tab. 141: Minimum quality requirements

Make sure following requirements are fulfilled:

- Oil viscosity is approved for hydraulic oil cooler

If gear oils from other manufacturers are used, information on change intervals must be obtained from respective manufacturer or supplier.

For fuel and operating fluids that only meet the minimum requirements, it is possible that the oil service life may differ from that of the Liebherr recommendation.

5.3.12 Greases

Liebherr recommendation

Ambient temperature	Description
Down to -4 °F	Liebherr Universalfett 9900
Down to -67 °F	Liebherr Universalfett Arctic

Tab. 142: Liebherr recommendation

Minimum quality requirements

Thickener	Shelf life	Specification
Soap-based (lithium complex)	At least 3 years	Pumpable according to KP 2 K (DIN 51502)
		VKA welding force: ≥ 2300 N (DIN 51350/4, ASTM D 2596)

Tab. 143: Minimum quality requirements

5.3.13 Windscreen washer fluid

Liebherr recommendation

Liebherr recommends commercial washer fluid with anti-freeze.

If it is not possible to retract piston rods fully into cylinders:

- ▶ Apply corrosion inhibitor to exposed areas of piston rods.
- ▶ After loading the machine check corrosion protection of the piston rods.
- ▶ After reparking the machine check corrosion protection of the piston rods.

5.6.3 Cleaning the machine

In the following situations, thoroughly clean machine to remove all traces of contamination and dirt deposits:

- After each work deployment
- Before maintenance work
- Before repair work

NOTICE

Aggressive materials and working environment!

Corrosion damage to machine or impairment of function.

If machine has come into contact with aggressive materials or has been working in an aggressive working environment:

- ▶ Clean machine at end of work.
-

Regular cleaning prevents dirt and foreign particles from penetrating machine.

Clean machine immediately after following deployments:

- Working in salty environments (for example in contact with road salt, or by the sea)
- Working with alkalis or acids
- Working with aggressive materials (for example calcium compounds, cement)

NOTICE

Incorrect cleaning with high pressure water or steam cleaning!

Damage to electrical systems, cables and wire harnesses.

- ▶ Clean electrical systems, cables and wire harnesses with low pressure.
 - ▶ Observe instructions of high pressure cleaner manufacturer.
-

NOTICE

Incorrect cleaning with high pressure water or steam cleaning!

Damage to paint.

- ▶ Do not clean machine with a high pressure cleaner for two months after first putting it into service (or after respraying).
 - ▶ Observe instructions of high pressure cleaner manufacturer.
-

Cleaning outside of machine

Before cleaning

Before cleaning with water or a high-pressure cleaner, perform following activities in order to avoid water penetration.

- ▶ Turn ignition button to position **0**.
- ▶ Lubricate all bearings, pin connections and slewing ring, using central lubrication system, if available.

Position	Assembly	Visual inspection for defects
1	Steel frame of working attachment	Check bearing points, supports, holders, fastening elements, connections for damage, warping and cracks.
2	Steel frame of uppercarriage	
3	Steel frame of undercarriage and turret	
4	Steel frame of climbing aids and hand rails	
5	Steel frame of operator's cab	
6	Steel frame of quick coupler and working tool	

Tab. 152: Visual inspection for defects

- ▶ Perform visual inspection. (For more information see: [Definition of visual inspection, page 298](#))

If defects occur in machine:

- ▶ Record any identified defects.
- ▶ Inform operating company of defects affecting safety.
- ▶ Repair identified defects. See service manual for procedure.

If service manual cannot be accessed:

- ▶ Have repairs performed by Liebherr customer service.

5.7.4 Lubricating hinges, locks and gas pressure springs of doors, hoods and windows

- ▶ Lubricate hinges regularly with oil or grease.
- ▶ Regularly lubricate locks with resin-free oil or commercially available door lock care product (with graphite or MoS₂ compounds).
- ▶ Lubricate the joints of the gas pressure springs regularly with oil or grease.

**CAUTION**

Hot gear oil!
Burns.

- ▶ Let gearbox cool down.
- ▶ Wear gloves.
- ▶ Avoid skin contact with hot gearbox.
- ▶ Avoid skin contact with hot gear oil.

Make sure the following preconditions are met:

- Machine is horizontal.
- ▶ Shut off diesel engine.
- ▶ Wait a few minutes until oil has collected in oil pan.
- ▶ Unscrew dipstick 1.
- ▶ Pull out dipstick 1.
- ▶ Clean dipstick 1 with clean lint-free cloth.
- ▶ Insert dipstick 1 fully.
- ▶ Pull out dipstick 1 again.
- ▶ Check that oil level is between **min** mark and **max** mark on dipstick 1.

NOTICE

Incorrect mixture of gear oils!
Damage to gearbox.

- ▶ Do not mix gear oils.

NOTICE

Unsuitable gear oil!
Damage to gearbox.

- ▶ Exclusively use gear oil in approved quality.

If oil level is below **min** mark:

- ▶ Fill with oil until **max** mark is reached.
- ▶ Screw in dipstick 1.

5.8.9 Diesel particulate filter: Activating and deactivating regeneration

Operating condition of diesel particulate filter

Following symbols and menus indicate the operating condition of the diesel particulate filter on the display:

- *Start page* menu
- *Diesel particulate filter* menu
- Bar chart display
- Status symbols
- Warning symbols

Manually lubricating oscillating axle and steered rigid axle at central lubrication point (option)

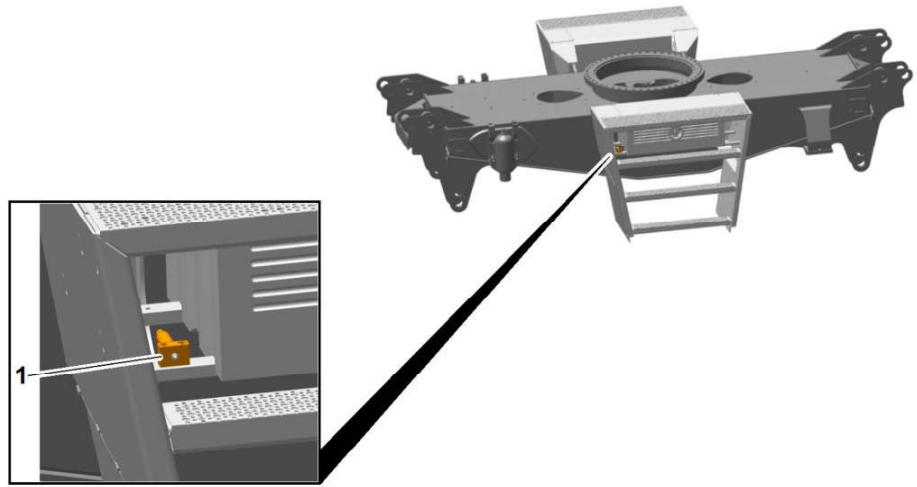

Fig. 1001: Position of central lubrication point

1 Central lubrication point

- ▶ Remove dust protection cap from grease fitting of central lubrication point 1.
- ▶ Use grease gun to inject grease in grease fitting of central lubrication point 1 until clean grease emerges from bearings of oscillating axle and steered rigid axle.
- ▶ Put dust protection cover on grease fitting of central lubrication point 1.

5.12.2 Tyres: checking foam-filled tyres



Note

The running characteristics change when tyres are filled with foam. This can adversely affect the performance of the machine.

- ▶ Use only foam-filled tires supplied by Liebherr.

5.12.3 Wheels: Checking mounting of wheel nuts



DANGER

Incorrectly tightened wheel nuts!
Danger to life.

- ▶ Make sure that all wheel nuts are tightened with specified tightening torque.
- ▶ Check tightening torque after 50, 100 and 250 operating hours.

Make sure the following preconditions are met:

- Machine is parked on level and firm ground.
- Machine is secured with chocks to prevent it from rolling away.
- A torque wrench with a sufficient setting range is available.

5.16 Slewing gearbox and slewing ring

5.16.1 Slewing gearbox: Checking oil level

Checking oil level

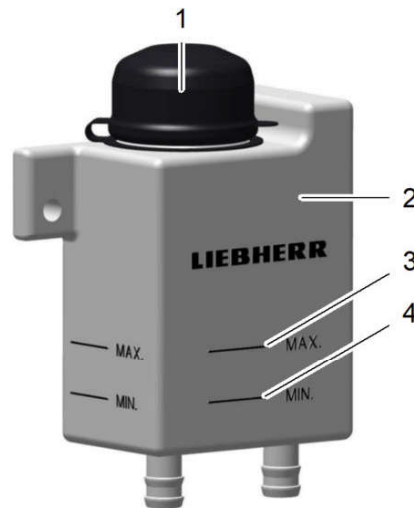

Fig. 1013: Oil tank of slewing gearbox

- | | | | |
|---|----------------|---|------------|
| 1 | Protective cap | 3 | MAX |
| 2 | Oil tank | 4 | MIN |

- ▶ Check that oil level is between **MIN 4** and **MAX 3** marks.

If oil level is below **MIN 4** mark:

- ▶ Check tightness.
- ▶ Fill with oil.

Checking tightness

- ▶ Check slewing gearbox, oil tank, connecting hoses, connections and covers for tightness.
- ▶ Repair or replace leaking components. For procedure see service manual under chapter 180.

If service manual cannot be accessed:

- ▶ Have repairs performed by Liebherr customer service.

Filling with oil

NOTICE

Incorrectly mixed gear oils!
Damage to transmission.

- ▶ Do not mix gear oils.

CLICK HERE TO **DOWNLOAD** THE COMPLETE MANUAL

- Thank you very much for reading the preview of the manual.
- You can download the complete manual from: www.heydownloads.com by clicking the link below



- Please note: If there is no response to CLICKING the link, please download this PDF first and then click on it.

CLICK HERE TO **DOWNLOAD** THE COMPLETE MANUAL