



Bobcat®

Operation & Maintenance Manual



3PT Box Blade

(48) S/N B4UG00101 & Above
(60) S/N B4UH00101 & Above
(72) S/N B4UJ00101 & Above



CLICK HERE TO **DOWNLOAD** THE COMPLETE MANUAL

- Thank you very much for reading the preview of the manual.
- You can download the complete manual from: www.heydownloads.com by clicking the link below



- Please note: If there is no response to CLICKING the link, please download this PDF first and then click on it.

CLICK HERE TO **DOWNLOAD** THE COMPLETE MANUAL

FEATURES AND ACCESSORIES

Standard Items

The three-point box blade is equipped with the following Standard Items:

- Category I hitch
- Two reversible / interchangeable blades
- Adjustable / replaceable scarifier shanks

IMPLEMENT SIGNS (DECALS)

Follow the instructions on all the Implement Signs (Decals) that are on the implement. Replace any damaged implement signs and be sure they are in the correct locations. Implement signs are available from your Bobcat implement dealer.



7189200 (2)

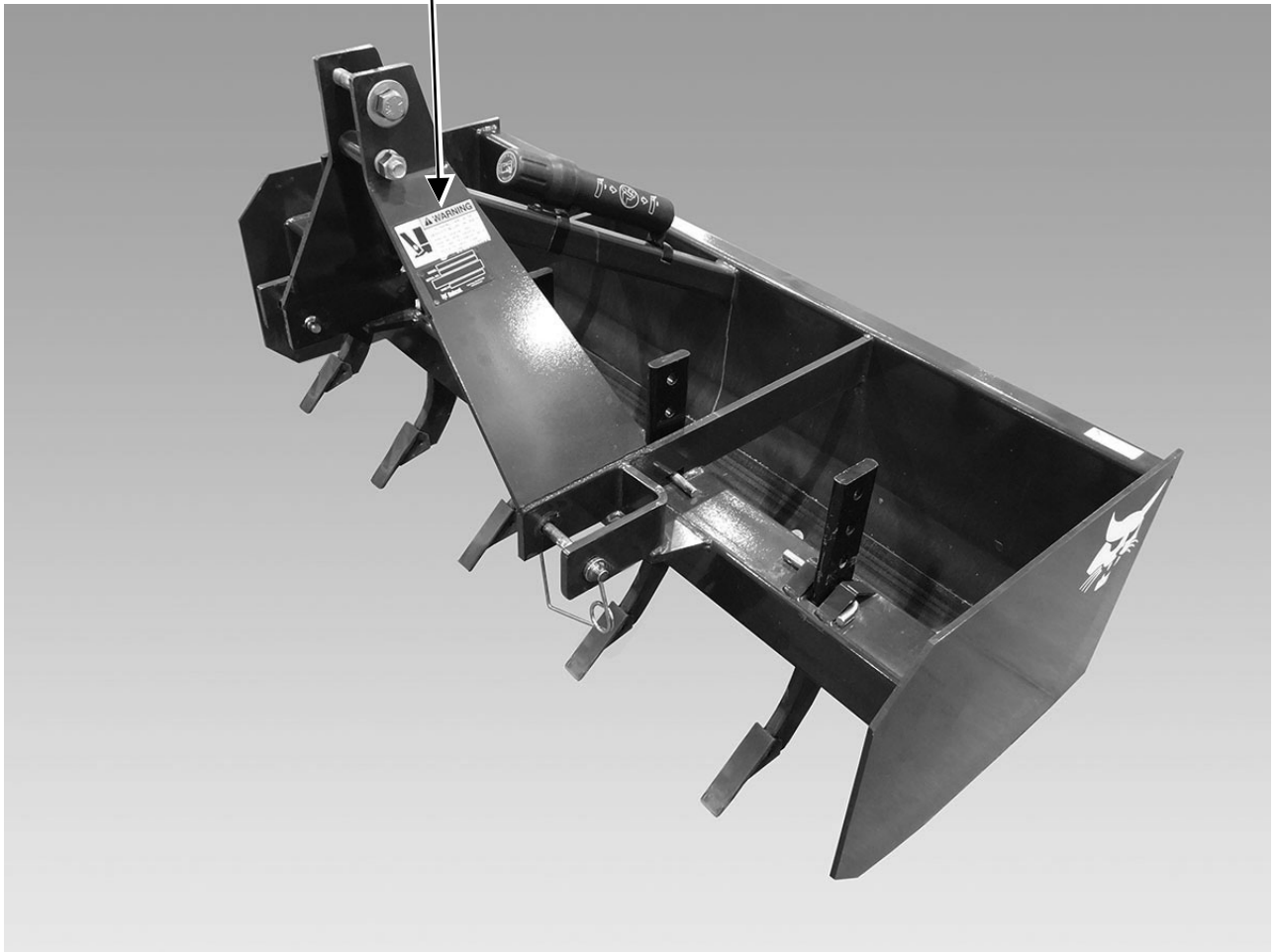

P142002

OPERATING PROCEDURE WITH COMPACT TRACTORS (CONT'D)

Installation (Cont'd)

Lift Link Adjustment

Figure 13

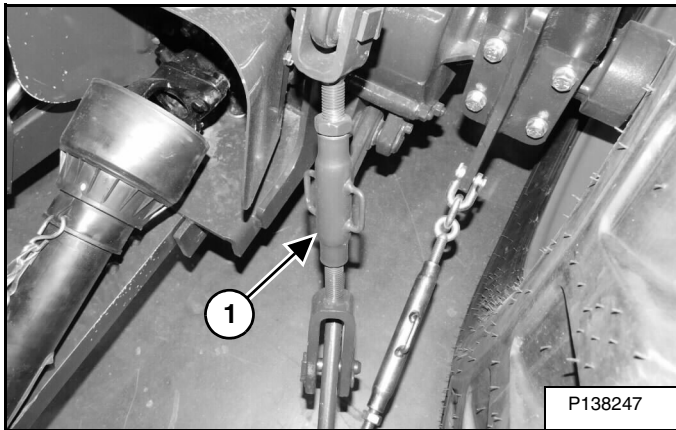

The lift link (Item 1) **[Figure 13]** is used to adjust the side to side level of the implement.

See the compact tractor Operation & Maintenance Manual and Operator's Handbook for detailed information on adjusting the lift link.

Top Link Adjustment

Figure 14

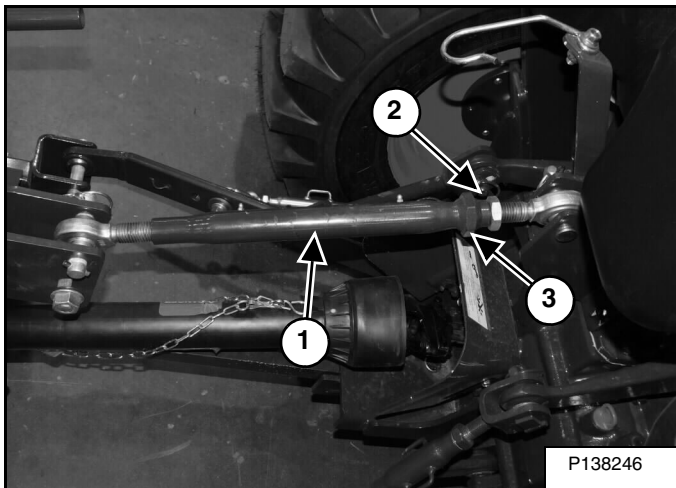

The top link (Item 1) **[Figure 14]** is used to adjust the front to back level of the implement.

Loosen the locknut (Item 2) and use the adjuster (Item 3) **[Figure 14]** to lengthen or shorten the top link.

Turn clockwise to lengthen the top link, turn counterclockwise to shorten top link.

After the implement has been leveled, tighten the locknut (Item 2) **[Figure 14]**.

Sway Bar Adjustment

Figure 15

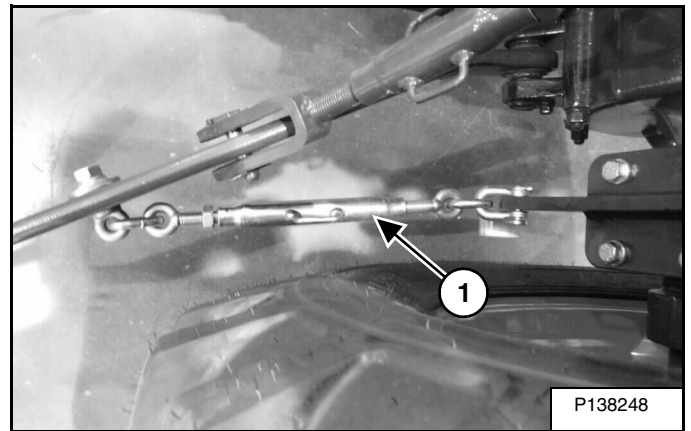

The sway bars (Item 1) **[Figure 15]** (both sides) are used to center the implement between the tires and limits the implements side to side movement.

Adjust the sway bars to center the implement between the tires. See the compact tractor Operation & Maintenance Manual and Operator's Handbook for detailed information on adjusting sway bars.

NOTE: When adjusting the sway bars with the implement installed, the implement will need to be raised slightly off of the ground.

MAINTENANCE SAFETY



WARNING







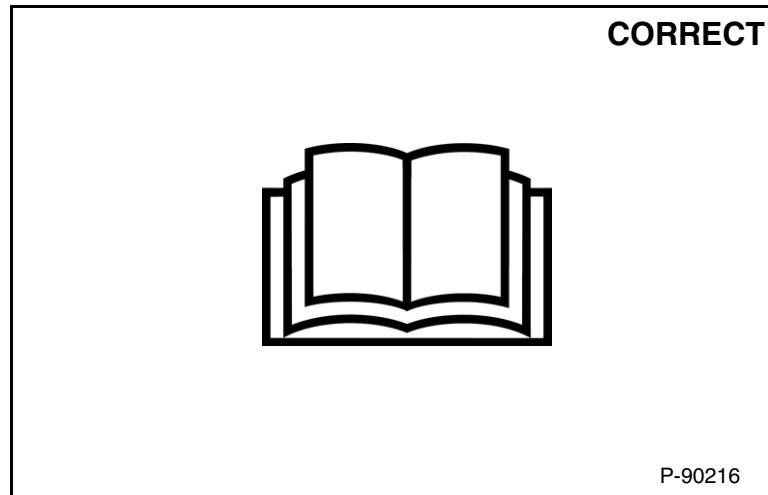

Instructions are necessary before operating or servicing machine. Read and understand the Operation & Maintenance Manual, Operator's Handbook and signs (decals) on machine. Follow warnings and instructions in the manuals when making repairs, adjustments or servicing. Check for correct function after adjustments, repairs or service. Untrained operators and failure to follow instructions can cause injury or death.

W-2003-0807



Safety Alert Symbol: This symbol with a warning statement, means: "Warning, be alert! Your safety is involved!" Carefully read the message that follows.



-  **Never service attachments / implements without instructions. See Operation & Maintenance Manual and Attachment / Implement Service Manual.**
-  **Cleaning and maintenance are required daily.**
-  **Never service or adjust attachment / implement with the engine running unless instructed to do so in manual.**
-  **Always lower the attachment / implement to the ground before lubricating or servicing.**
-  **Avoid contact with leaking hydraulic fluid or diesel fuel under pressure. It can penetrate skin or eyes.**
-  **Stop, cool and clean engine of flammable materials before checking fluids.**
-  **Keep body, loose objects and clothing away from moving parts, electrical contacts, hot parts and exhaust.**
-  **Safety glasses are needed for eye protection from electrical arcs, battery acid, compressed springs, fluids under pressure and flying debris or when tools are used. Use eye protection approved for type of welding.**

MSW30-0409

THREE-POINT BOX BLADE SIGN TRANSLATIONS

Warning (7189200)

	 WARNING
	<p>CRUSHING CAN CAUSE SERIOUS INJURY OR DEATH</p> <ul style="list-style-type: none">• Keep all bystanders away from equipment when operating.• Fully lower the implement before leaving the operator's seat. <p>SW 19 7189200B enUS</p>

	 ADVERTENCIA
	<p>UN APLASTAMIENTO PUEDE PROVOCAR LESIONES GRAVES O FATALIDADES</p> <ul style="list-style-type: none">• Mantenga a todos los espectadores alejados del equipo en operación.• Descienda del todo el implement antes de abandonar el asiento del operador. <p>SW 19 7189200B esAR</p>

	 AVERTISSEMENT
	<p>UN ÉCRASEMENT PEUT PROVOQUER DES BLESSURES GRAVES, VOIRE MORTELLES</p> <ul style="list-style-type: none">• Tenir toutes les personnes présentes à l'écart de l'équipement en fonctionnement.• Abaisser complètement la machine avant de quitter le siège de l'opérateur. <p>SW 19 7189200B frCA</p>

CLICK HERE TO **DOWNLOAD** THE COMPLETE MANUAL

- Thank you very much for reading the preview of the manual.
- You can download the complete manual from: www.heydownloads.com by clicking the link below



- Please note: If there is no response to CLICKING the link, please download this PDF first and then click on it.

CLICK HERE TO **DOWNLOAD** THE COMPLETE MANUAL