

Anbauanleitung

GPS PILOT

Руководство по установке

GPS PILOT

Fitting Instructions

GPS PILOT

Notice de montage

GPS PILOT

Instrucciones de montaje

GPS PILOT

Istruzioni di montaggio

GPS PILOT



CLICK HERE TO **DOWNLOAD** THE COMPLETE MANUAL

- Thank you very much for reading the preview of the manual.
- You can download the complete manual from: www.heydownloads.com by clicking the link below



- Please note: If there is no response to CLICKING the link, please download this PDF first and then click on it.

CLICK HERE TO **DOWNLOAD** THE COMPLETE MANUAL

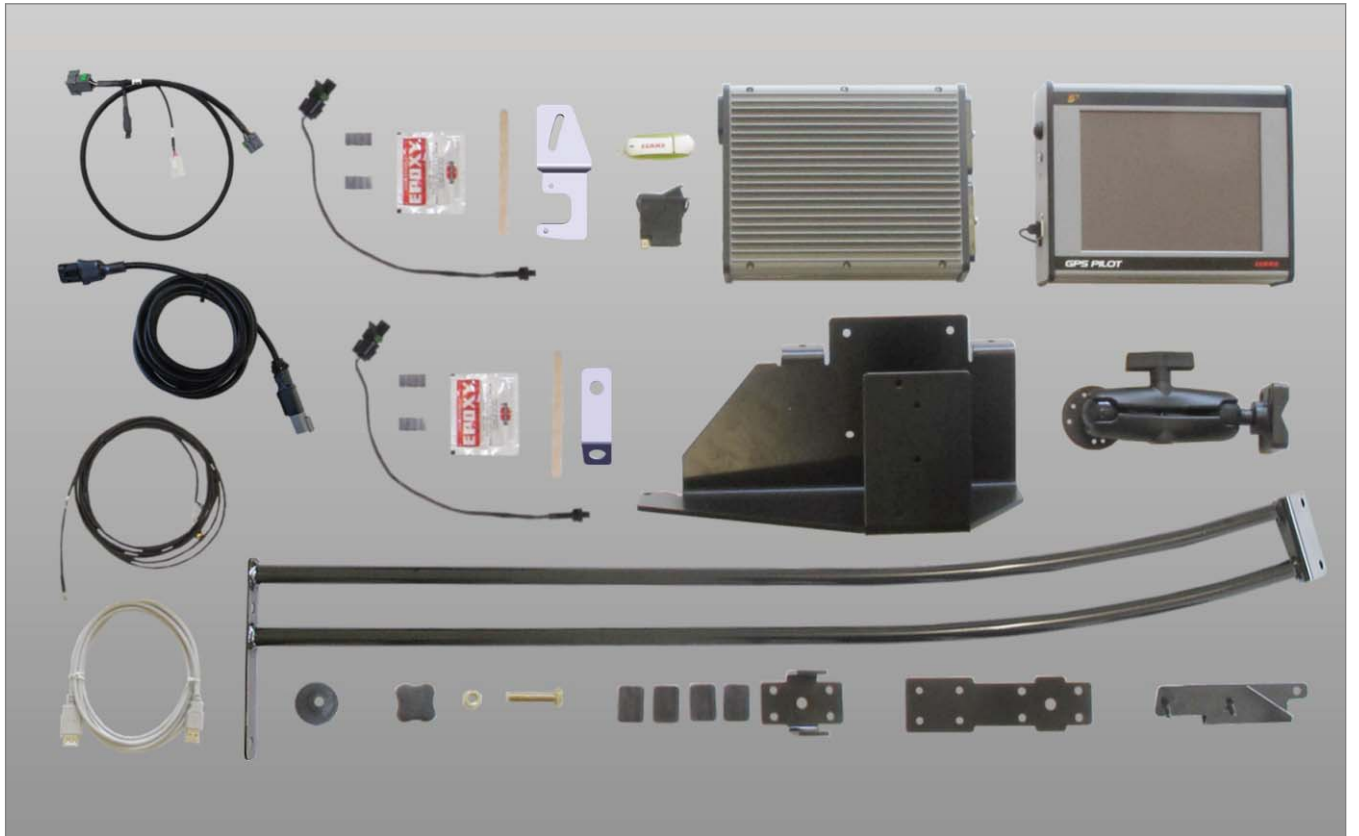

GPS PILOT

165206-002

2



EGNOS, BASELINE HD

165196-001

3

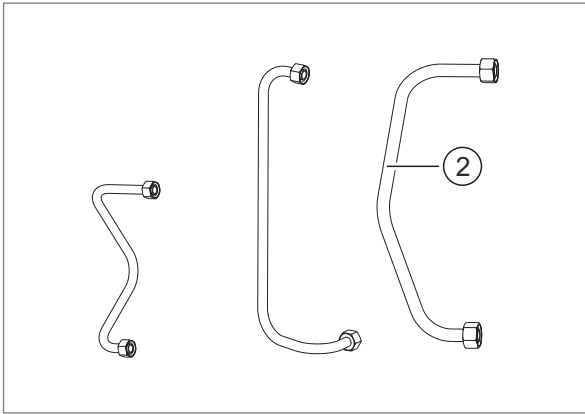

164724-002

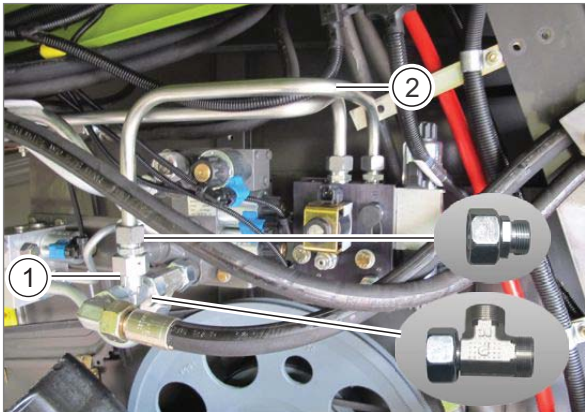

164337-001

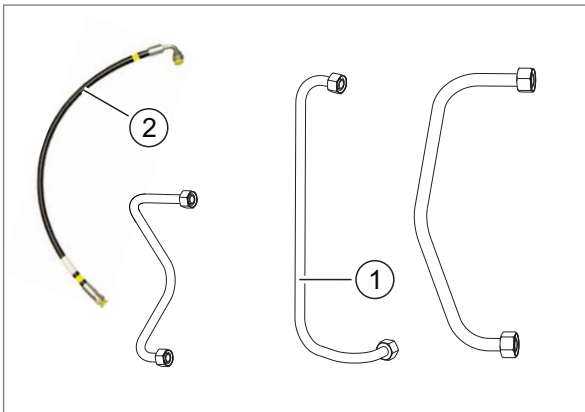

164725-002

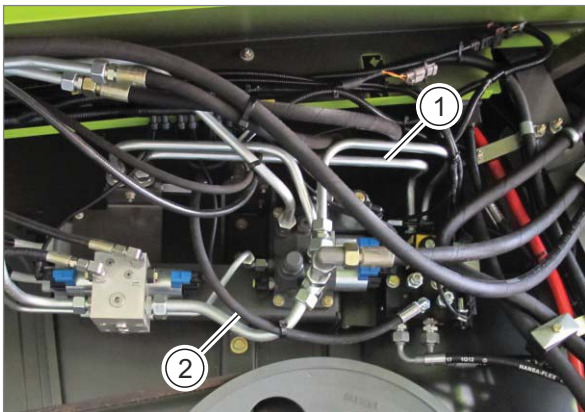

164429-002

1		-
2		T

25

26

1		CF - P
2		00 0483 453 0 LS - LS

27

28

00 0660 173 0

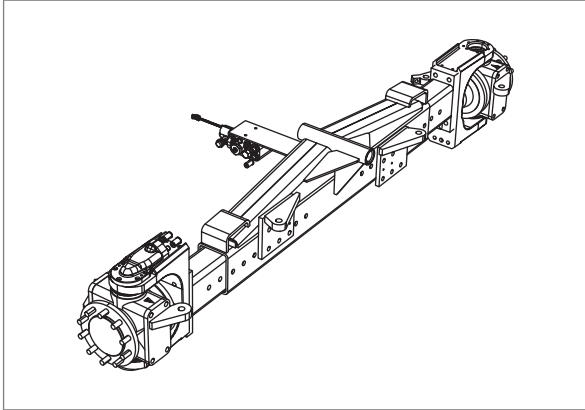

174175-001

52

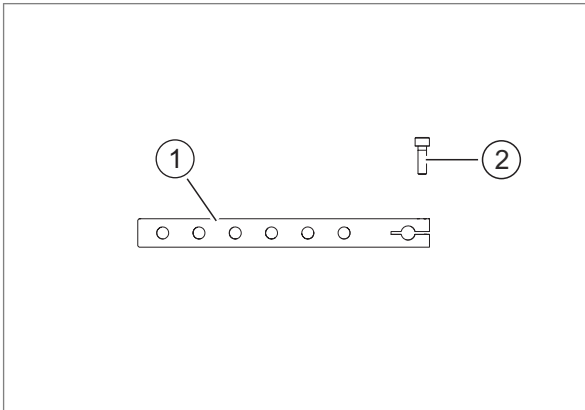

168107-001

53

1		-
2		-
3		M6x20 (1x)

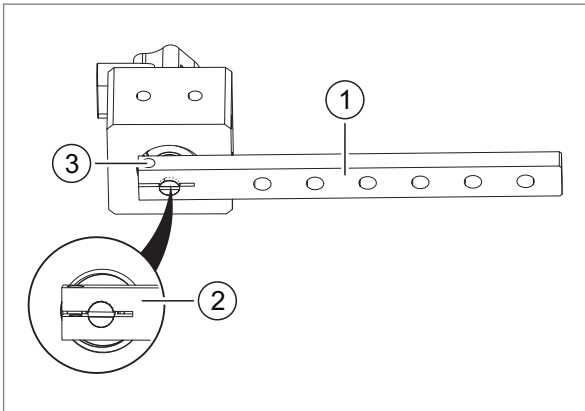

174895-001

54

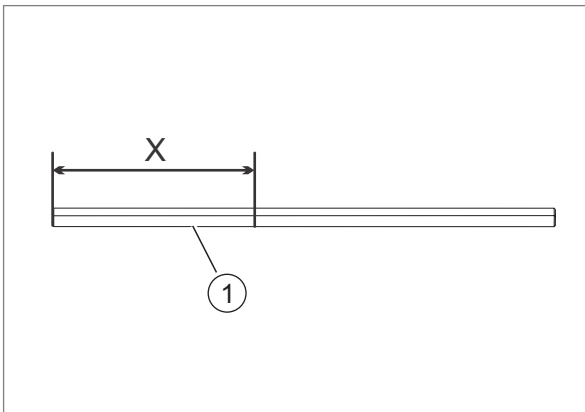

167425-001

55

1		X = 270mm
---	--	-----------

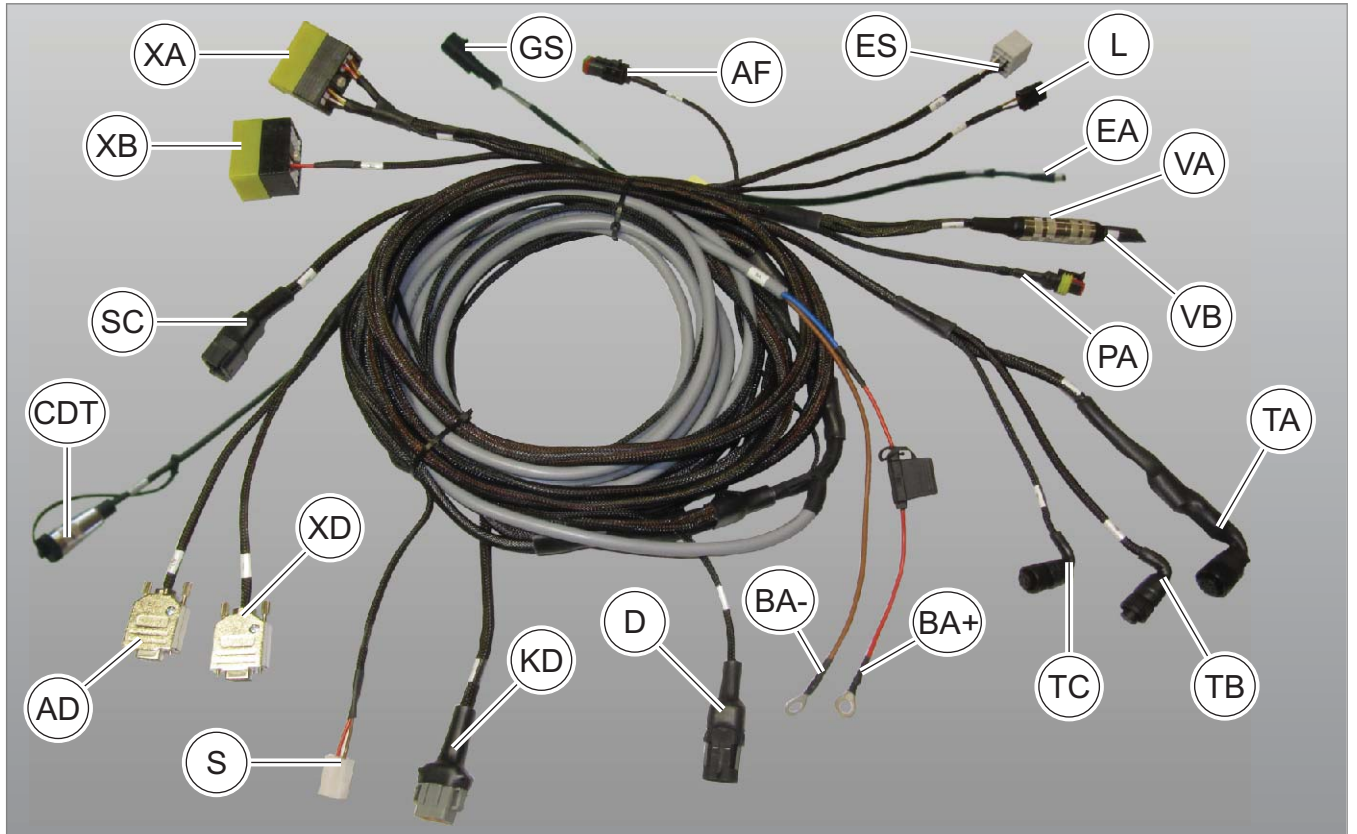

00 1401 005 2

139466-002

83

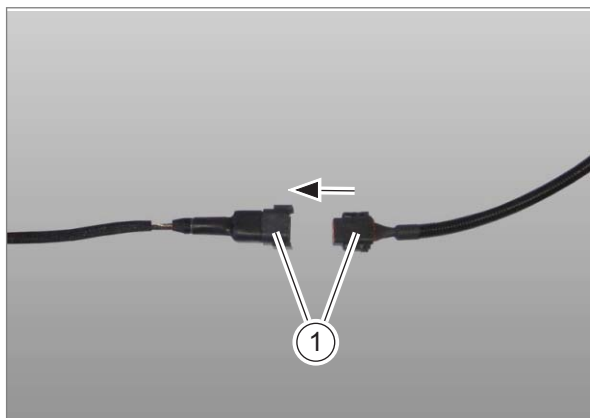

141009-001

1		00 1401 005 2 SC 00 1400 450 0 SC
---	--	--

84

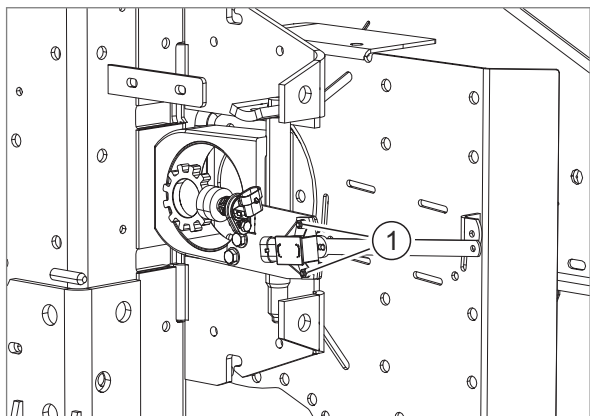

174872-001

1		-
---	--	---

85

CLICK HERE TO **DOWNLOAD** THE COMPLETE MANUAL

- Thank you very much for reading the preview of the manual.
- You can download the complete manual from: www.heydownloads.com by clicking the link below



- Please note: If there is no response to CLICKING the link, please download this PDF first and then click on it.

CLICK HERE TO **DOWNLOAD** THE COMPLETE MANUAL

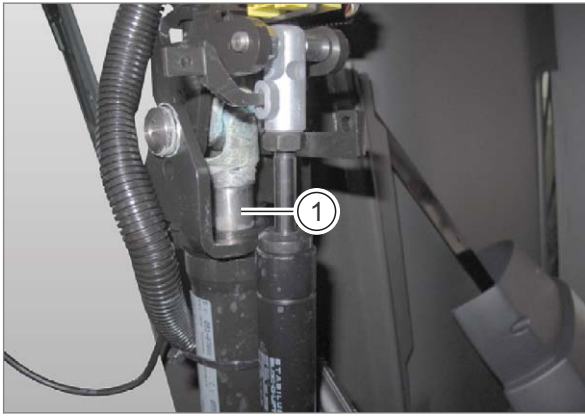

164547-001

118

1		2x 180°
---	--	---------

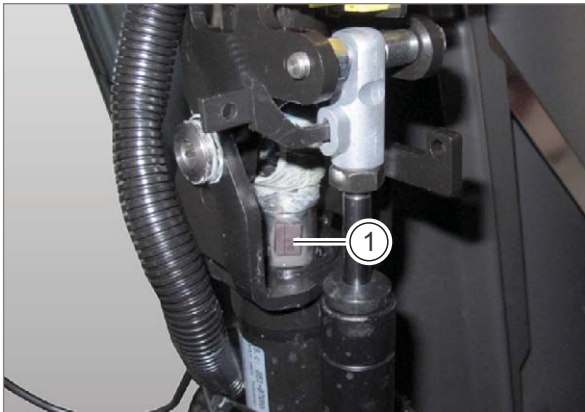

164550-001

119

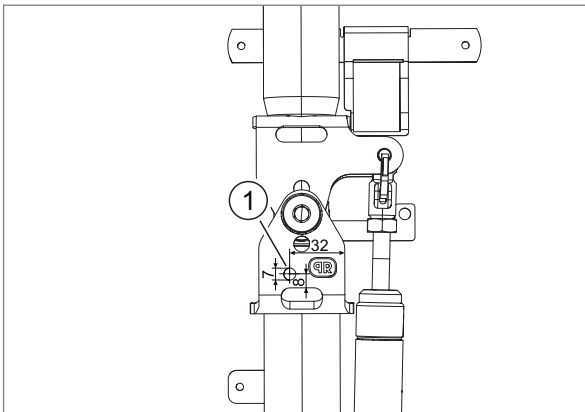

164548-002

120

1		-
		Ø 7mm

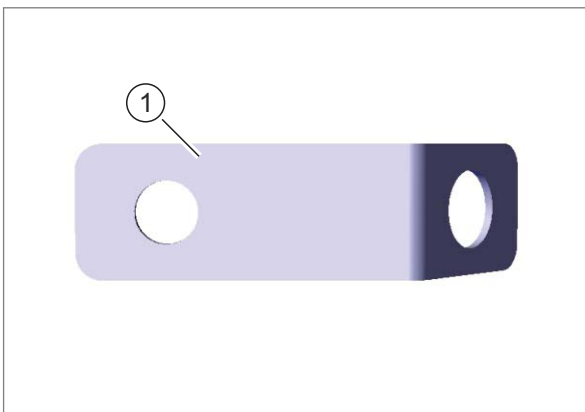

164695-002

121

1		M6x16 (1x) A6 (1x) M6 - ISO 4032 (1x)
2		X = 1 - 4mm
		-

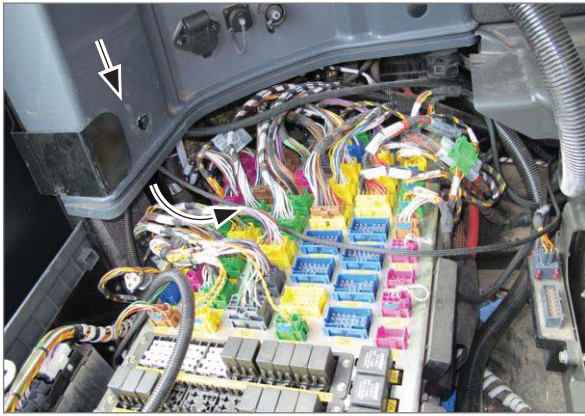

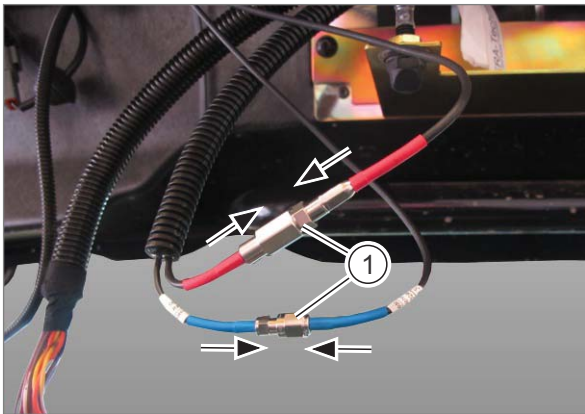

153253-001

151



161846-001

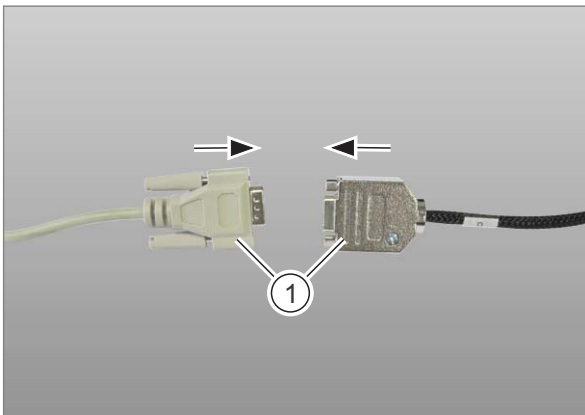

152

1		00 1402 488 0 00 1401 719 0
		



165653-001

153



1		00 1401 011 1 00 1400 998 0
		

* TELEMATICS



165654-001

154

1		00 1400 998 0
		

* TELEMATICS



165936-001

1		00 1401 009 1
---	--	---------------

178



164669-001

1		00 1401 009 1
---	--	---------------

179

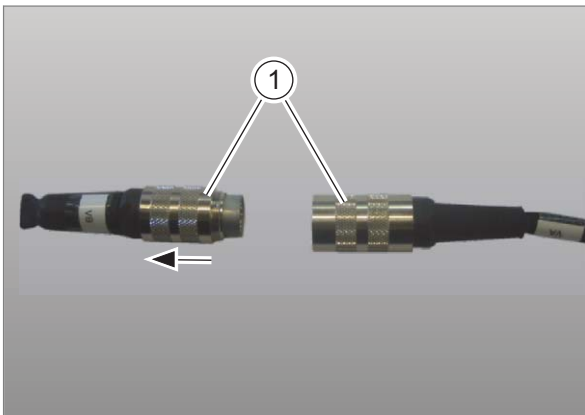

140328-002

1		00 1401 005 2 VA, VB
---	--	-------------------------

180

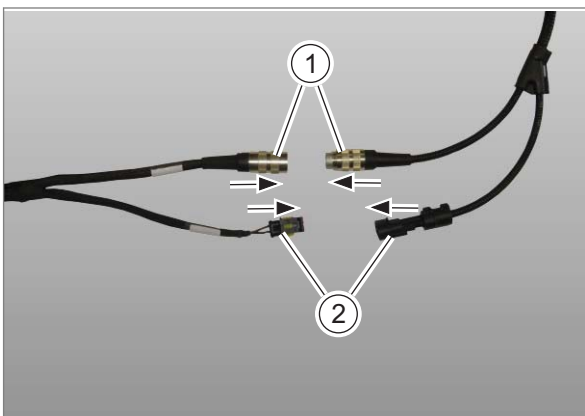

144569-001

1		00 1401 005 2 VA 00 1401 009 1
2		00 1401 005 2 PA 00 1401 009 1

181

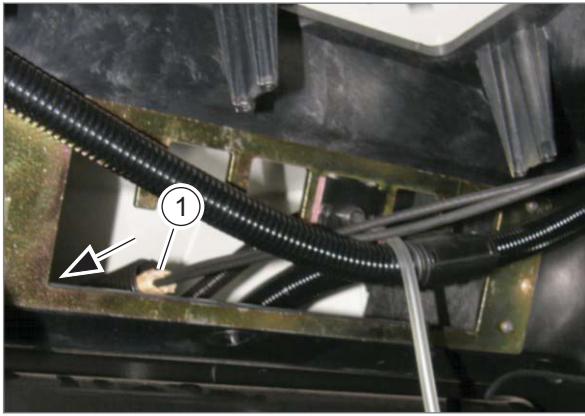

39479-002

206

1		00 1400 148 0
---	--	---------------

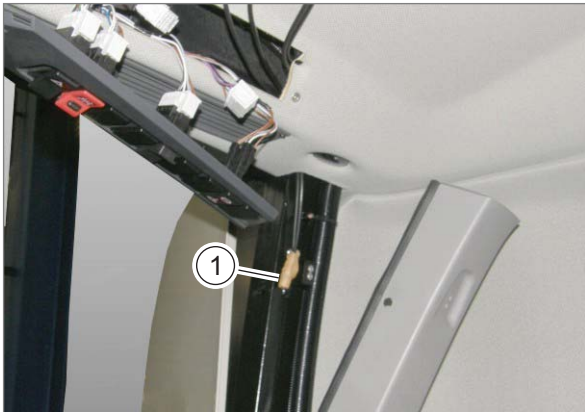

39480-002

207

1		00 1400 148 0
---	--	---------------



39486-002

208

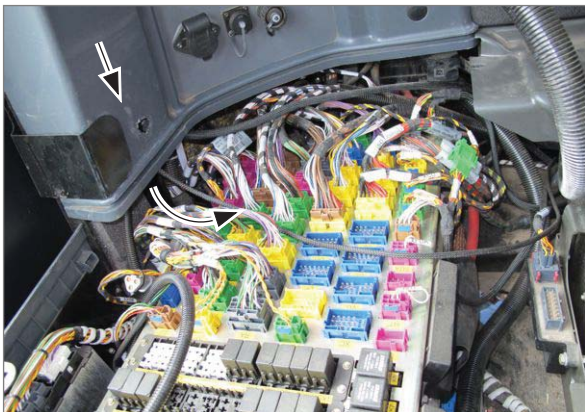

153253-001

209

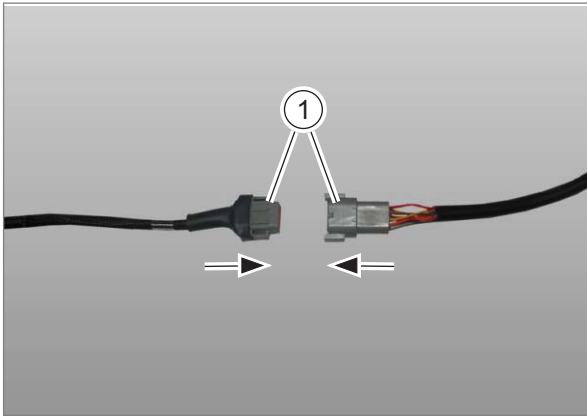

143179-001

237

1		00 1401 011 1 XM 00 1401 005 2 KD
---	--	--

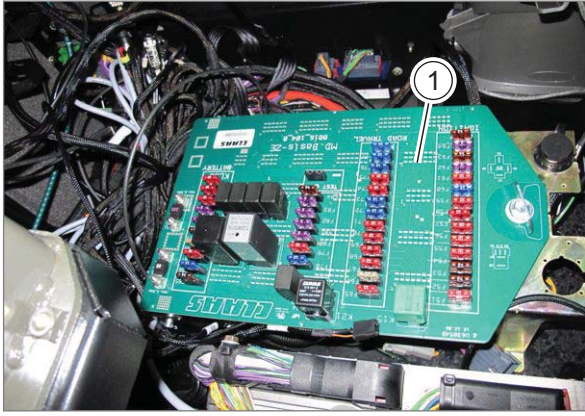

165030-001

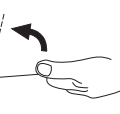
1		-
		

266

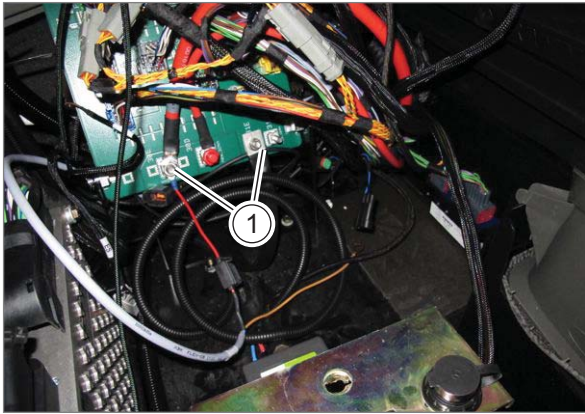

165031-001

1		-
---	---	---

267

CLICK HERE TO **DOWNLOAD** THE COMPLETE MANUAL

- Thank you very much for reading the preview of the manual.
- You can download the complete manual from: www.heydownloads.com by clicking the link below



- Please note: If there is no response to CLICKING the link, please download this PDF first and then click on it.

CLICK HERE TO **DOWNLOAD** THE COMPLETE MANUAL