

FENDT 900

XCC

CLAAS

Anbauanleitung

GPS PILOT

Руководство по установке

GPS PILOT

Fitting Instructions

GPS PILOT

Notice de montage

GPS PILOT

Instrucciones de montaje

GPS PILOT

Istruzioni di montaggio

GPS PILOT



Service & Parts

CLICK HERE TO **DOWNLOAD** THE COMPLETE MANUAL

- Thank you very much for reading the preview of the manual.
- You can download the complete manual from: www.heydownloads.com by clicking the link below



- Please note: If there is no response to CLICKING the link, please download this PDF first and then click on it.

CLICK HERE TO **DOWNLOAD** THE COMPLETE MANUAL

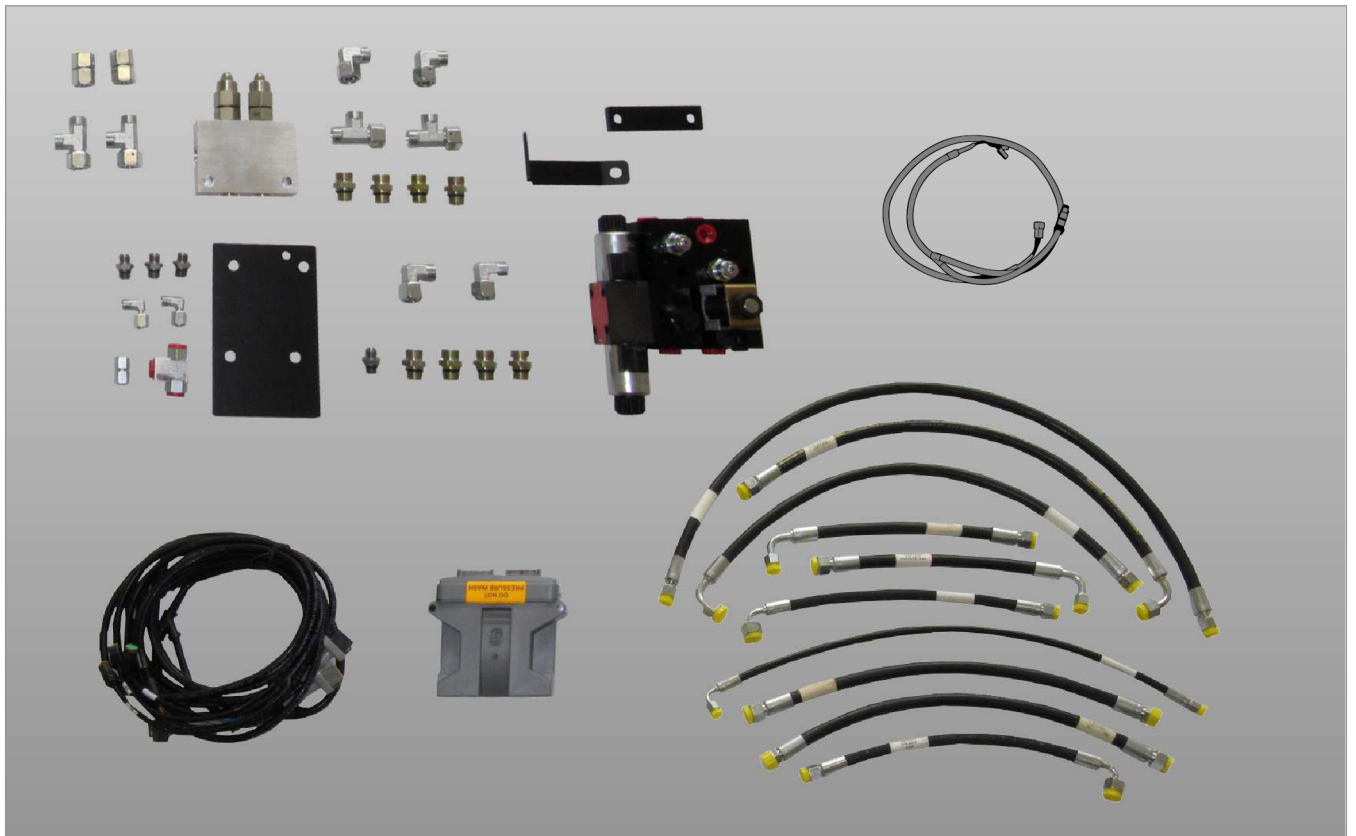

285964-001

1



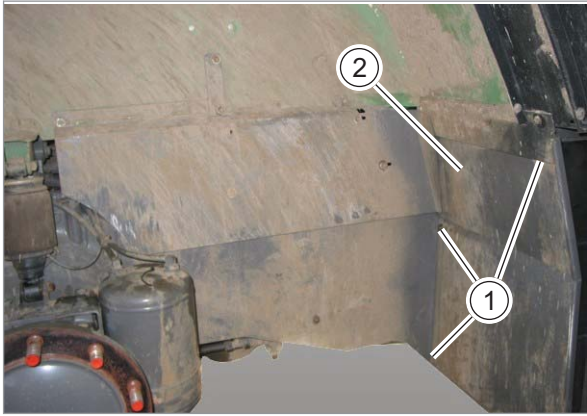

256732-001

2





143543-001

1		-
2		-

17





143544-001

1		-
2		-

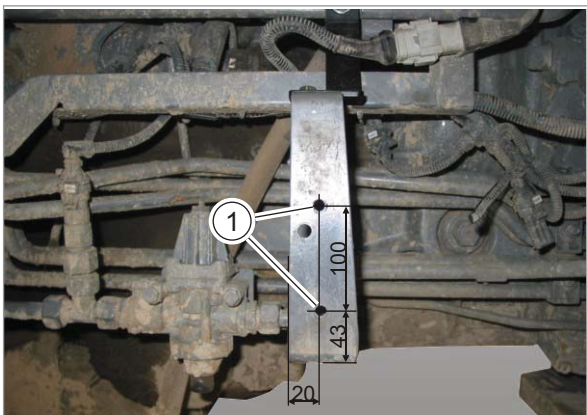
18

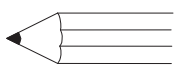

143549-001

1		-
		Ø 11mm

19

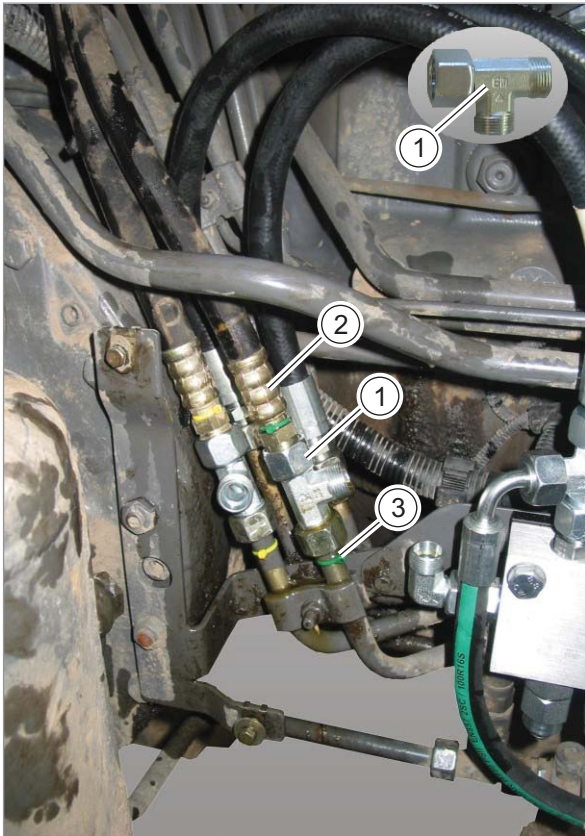

143532-001

1		-
2		-
3		B

53

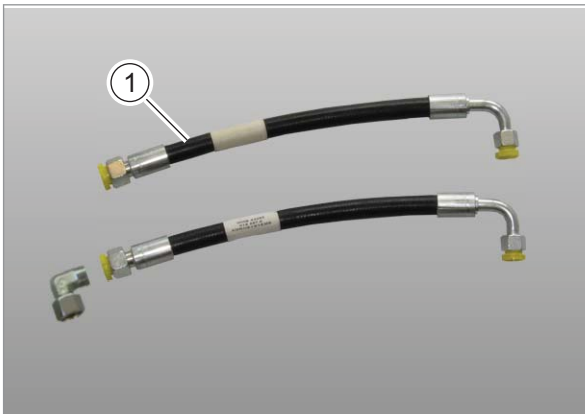

146377-001

1	 	00 0019 646 X
1		00 0019 646 X
2		B

54

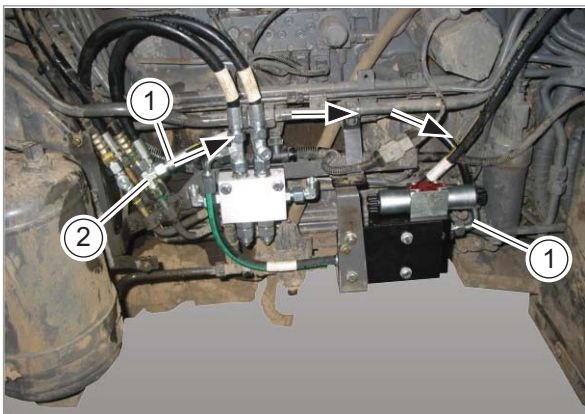

143533-001

55



149415-001

1		-
2		-

86

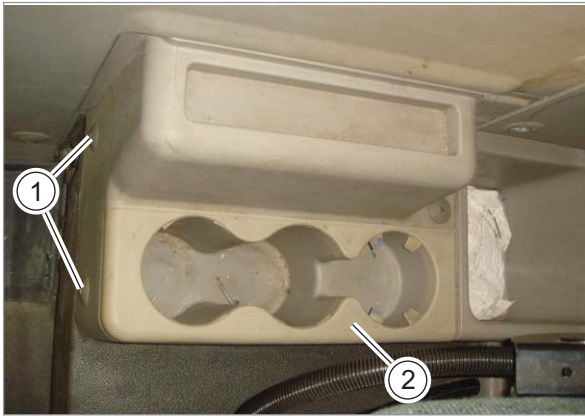

145801-002

87

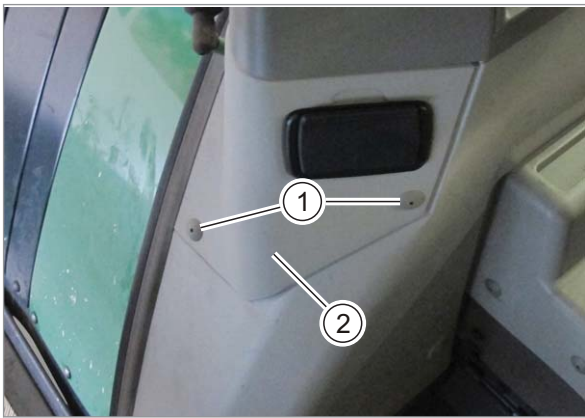

145204-002

1		-
2		-

88

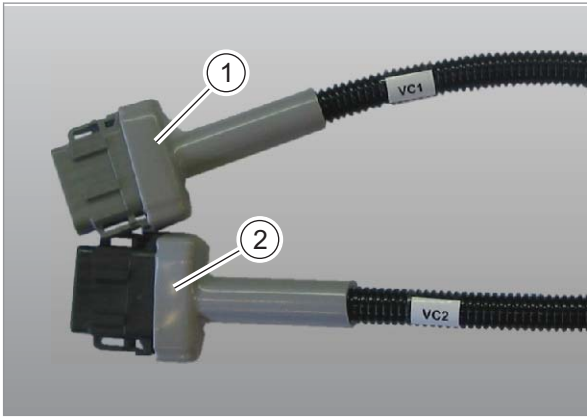

146086-001

1		00 1401 006 X X1A059
2		00 1401 006 X X2A059

115

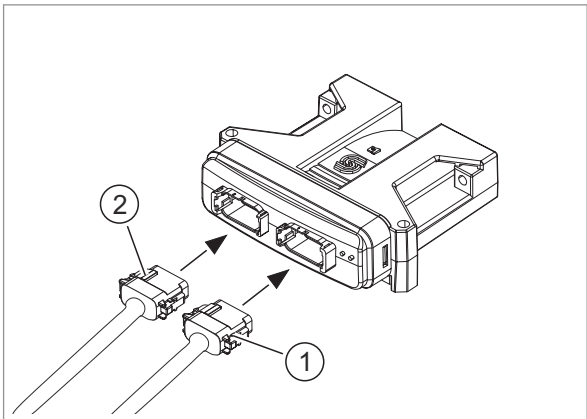

144571-002

116

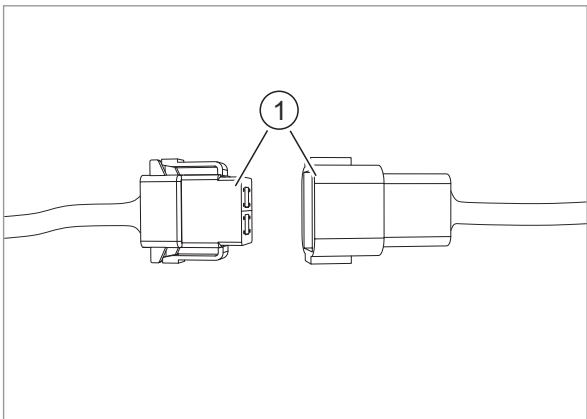

141009-002

117

1		00 1405 001 X XSCS 00 1401 006 X XSCS
---	--	--



143542-001

118

1		-
2		-

CLICK HERE TO **DOWNLOAD** THE COMPLETE MANUAL

- Thank you very much for reading the preview of the manual.
- You can download the complete manual from: www.heydownloads.com by clicking the link below



- Please note: If there is no response to CLICKING the link, please download this PDF first and then click on it.

CLICK HERE TO **DOWNLOAD** THE COMPLETE MANUAL



141917-001

146

1		-
---	--	---

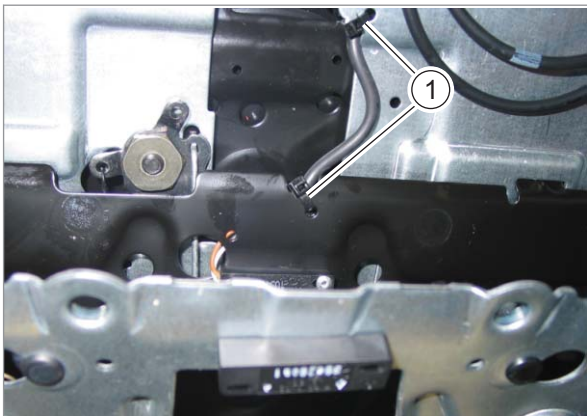

136588-001

147

1		-
---	--	---

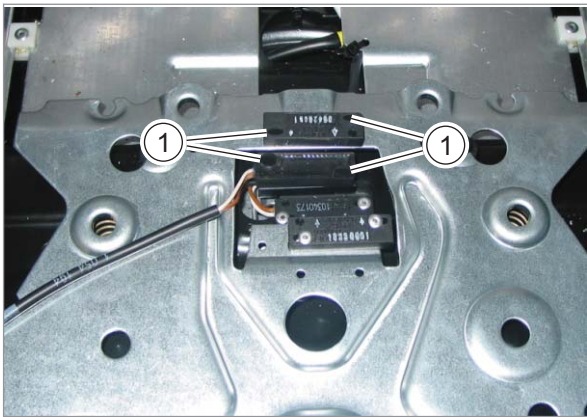

142618-001

148

1		-
2		-
3		Ø 3 mm
4		Ø 3,2 mm

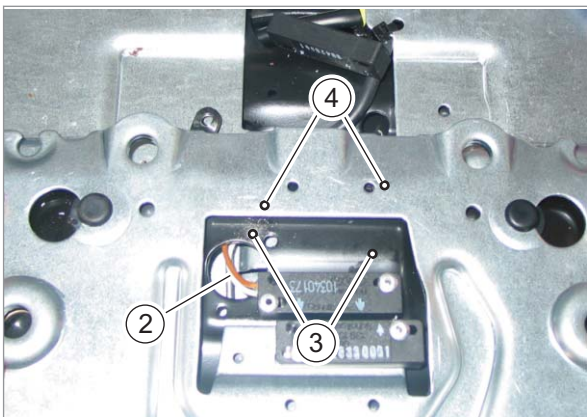

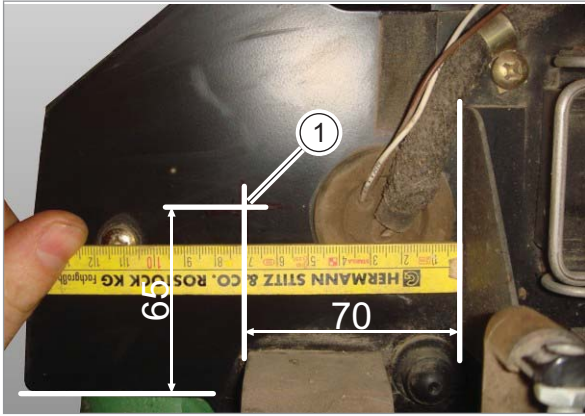

136589-002

149



145815-001

179

1		-
2		Ø 30 mm



145165-001

180

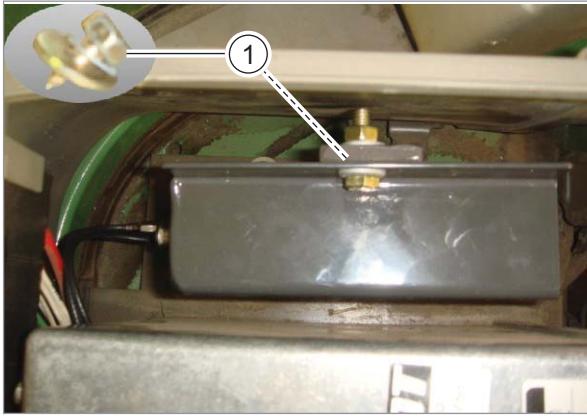

145501-001

211

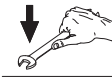
1		-
---	---	---

RTK (Motorola) / RTK FARM BASE

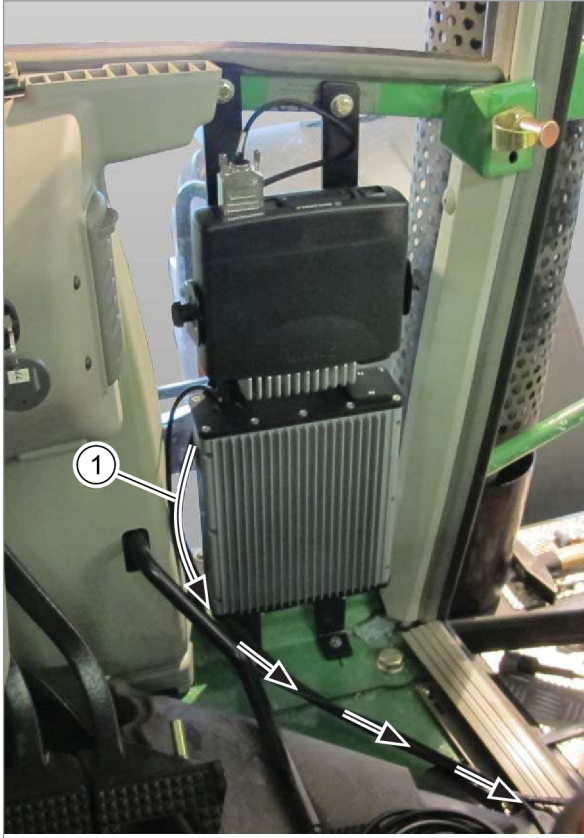

149521-002

236

1		<p>RTK (Motorola) 00 1405 010 X XKDS</p>
		<p>RTK FARM BASE 00 1405 008 X XKDS</p>

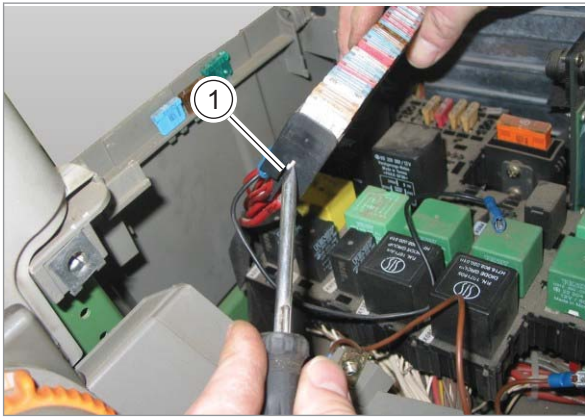

145322-001

266

1		-
---	--	---



145876-001

267

1		00 1405 005 X BA1
2		00 1405 005 X BA2

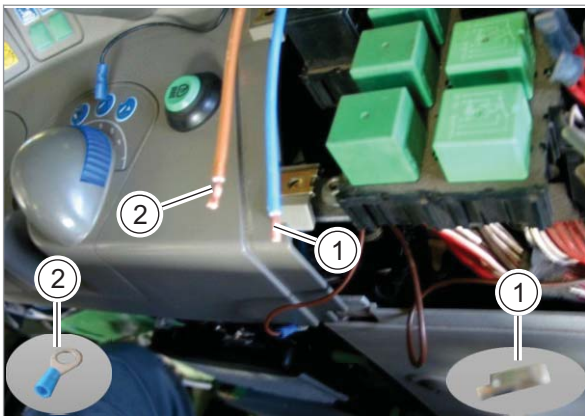

145314-001

268

1		00 1405 005 X BA1
---	--	----------------------

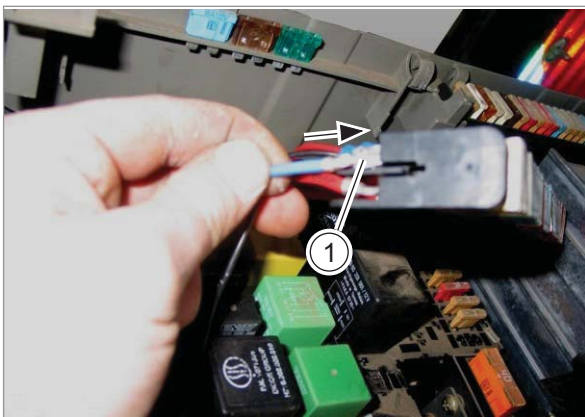

145316-001

269

S7

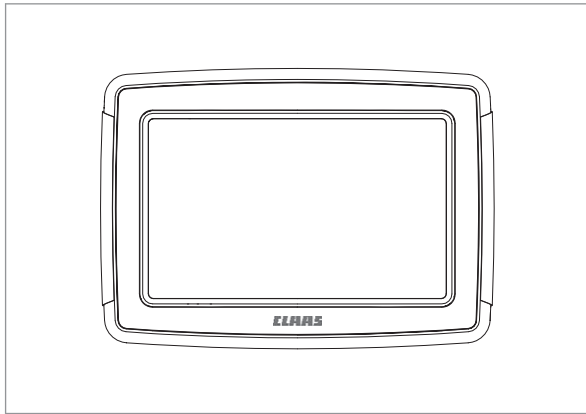

187320-001

297

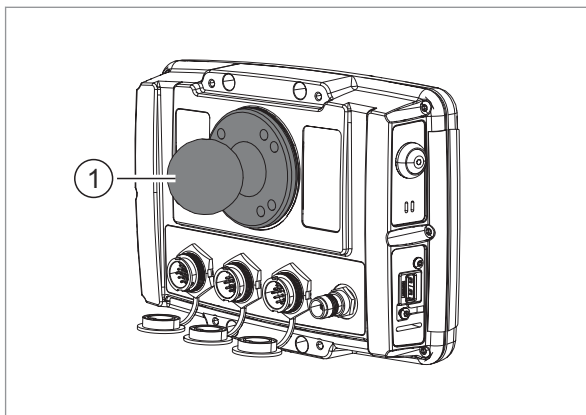

187352-001

298

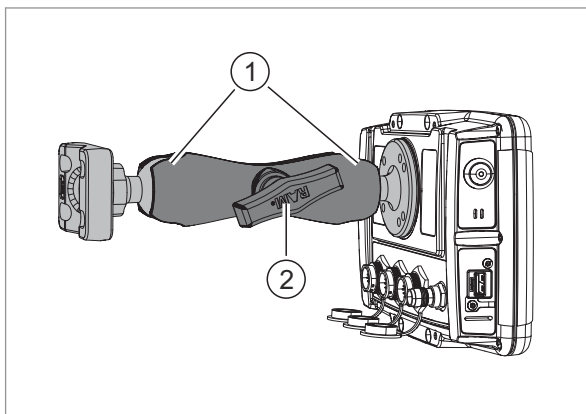
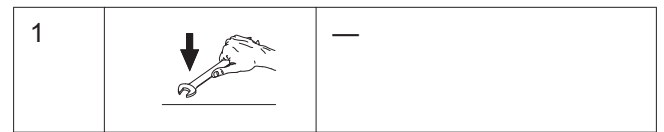

187354-001

299

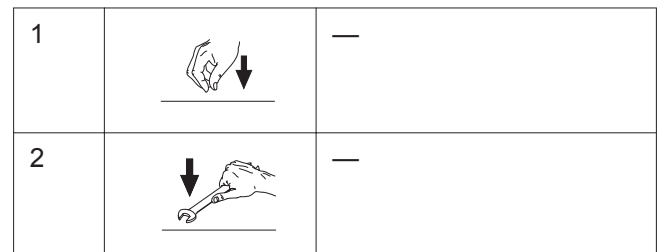

CLICK HERE TO **DOWNLOAD** THE COMPLETE MANUAL

- Thank you very much for reading the preview of the manual.
- You can download the complete manual from: www.heydownloads.com by clicking the link below



- Please note: If there is no response to CLICKING the link, please download this PDF first and then click on it.

CLICK HERE TO **DOWNLOAD** THE COMPLETE MANUAL