

Anbauanleitung

GPS PILOT FLEX

Fitting Instructions

GPS PILOT FLEX

Notice de montage

GPS PILOT FLEX

Instrucciones de montaje

GPS PILOT FLEX

Istruzioni di montaggio

GPS PILOT FLEX

Руководство по установке

GPS PILOT FLEX



CLICK HERE TO **DOWNLOAD** THE COMPLETE MANUAL

- Thank you very much for reading the preview of the manual.
- You can download the complete manual from: www.heydownloads.com by clicking the link below



- Please note: If there is no response to CLICKING the link, please download this PDF first and then click on it.

CLICK HERE TO **DOWNLOAD** THE COMPLETE MANUAL



GPS PILOT FLEX

172714-001

2



EGNOS, BASELINE HD

140347-001

3



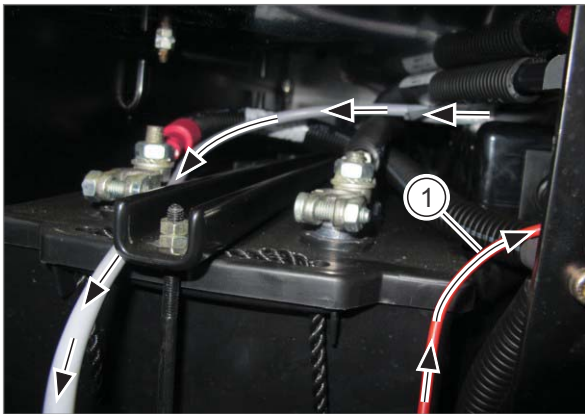

163799-001

26

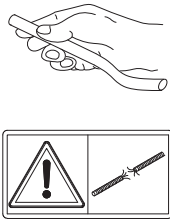

163797-001

27

1		00 1401 005 2 00 1405 100 0 BA +
2		BA +

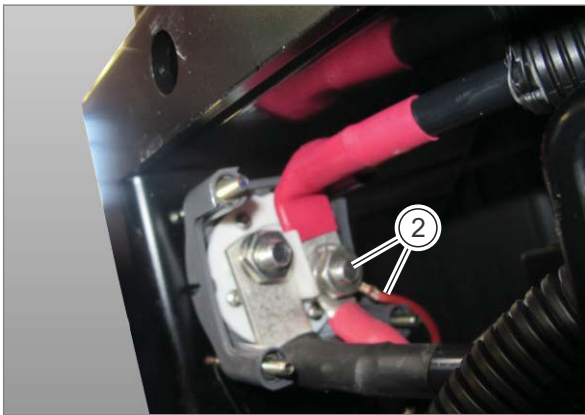

163798-001

28

1		-
---	---	---

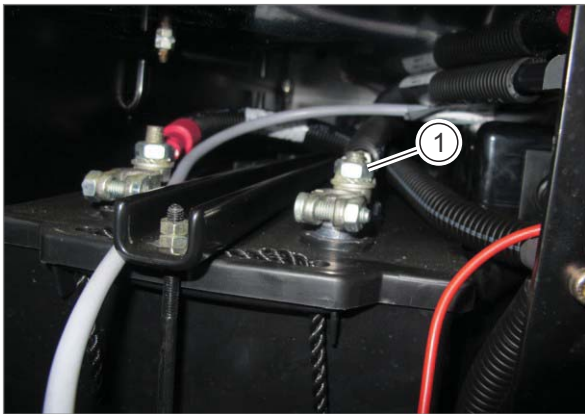

163795-001

29

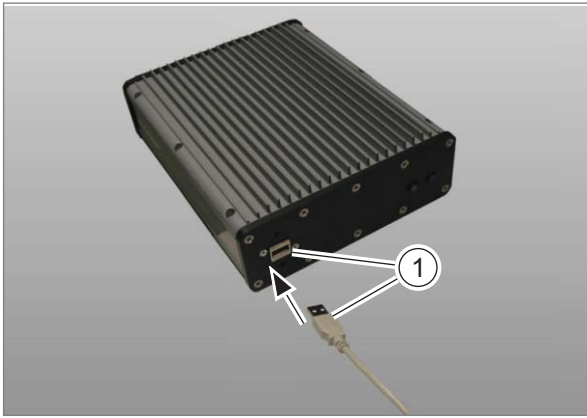

140569-001

1		00 1401 221 0
---	--	---------------

54

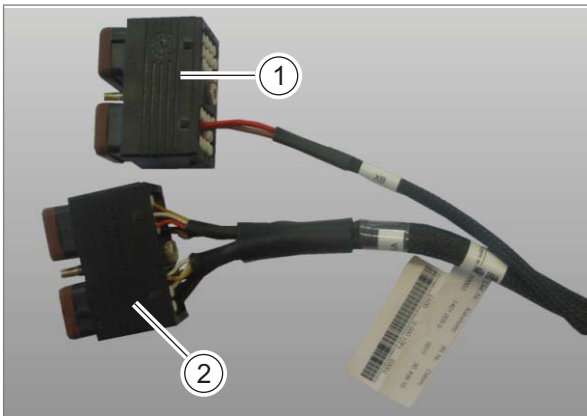

139559-001

1		00 1401 005 2 XB
2		00 1401 005 2 XA

55

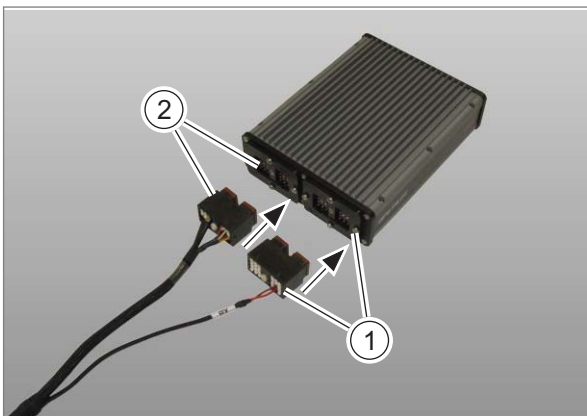

144562-001

56

1		M6x30 (4x) A6 (4x)
---	--	-----------------------

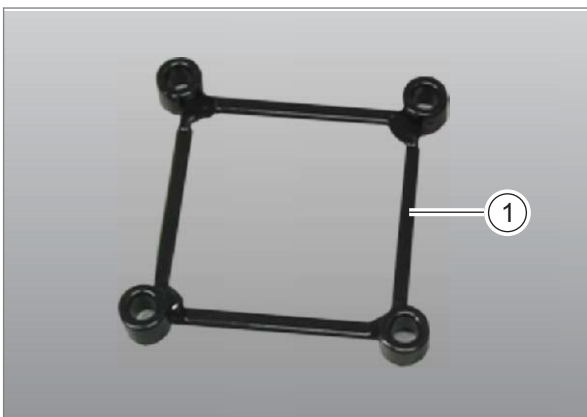

141164-001

57

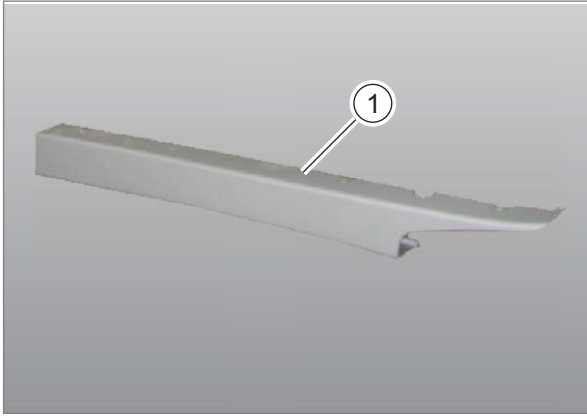

140580-001

1		-
2		-

87

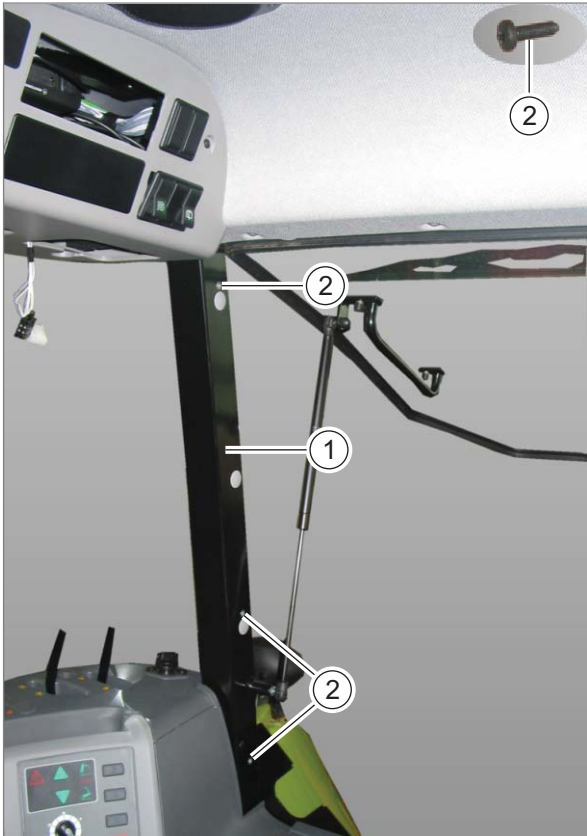

140592-001

88

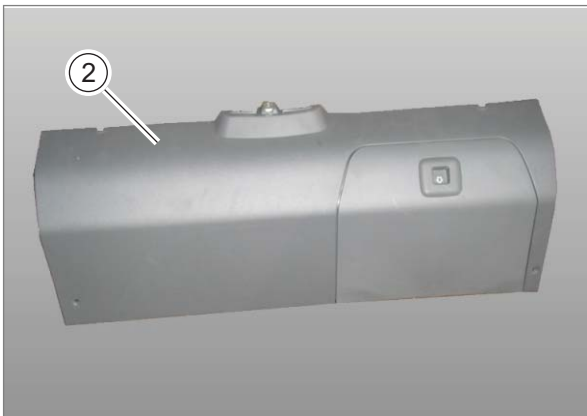

140582-001

1		-
2		-

89

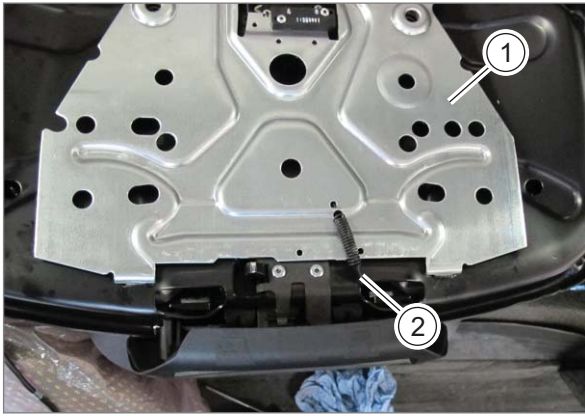

155443-001

1		-
2		-

113

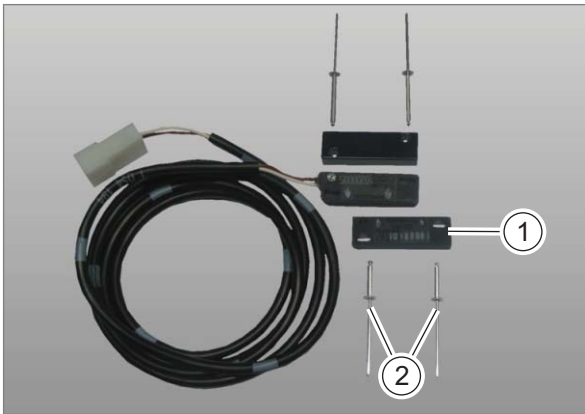

155463-001

1		-
2		3,2x15 (2x)

114

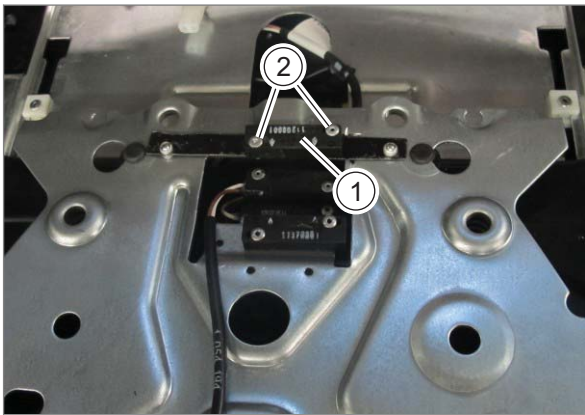

155441-001

115

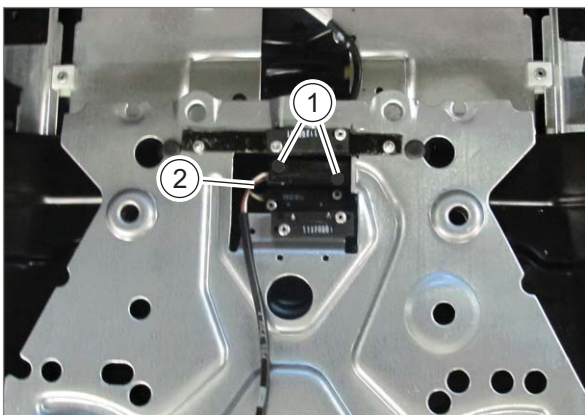

155444-001

116

1		-
		Ø 3mm
2		-



156285-001

1		M6x50 (1x) A6 (1x)
---	--	-----------------------

140

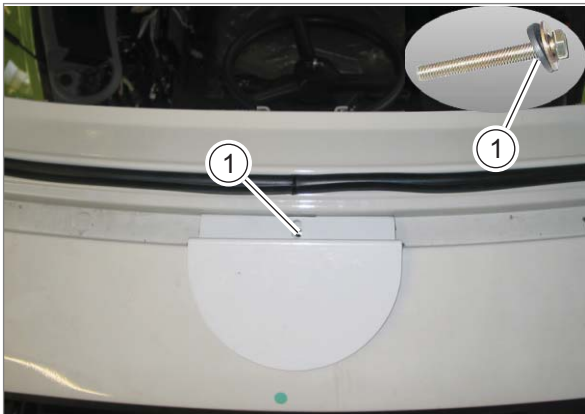

136527-001

141

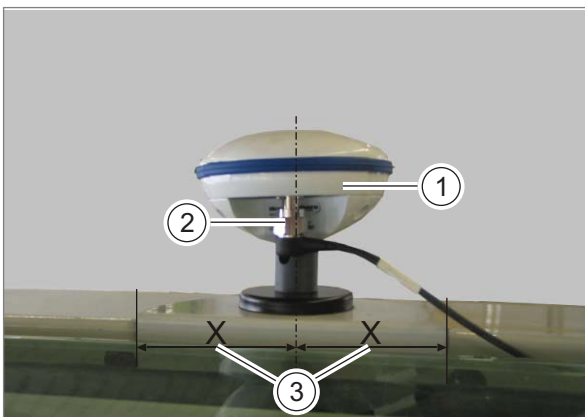

136449-001

1		-
2		00 1400 150 0
3		X = X

142

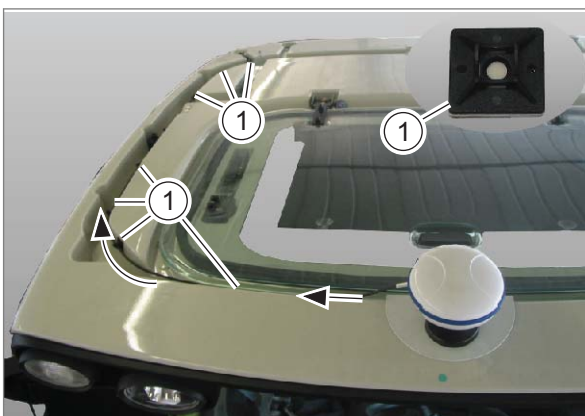

136529-001

1		-
---	--	---

143

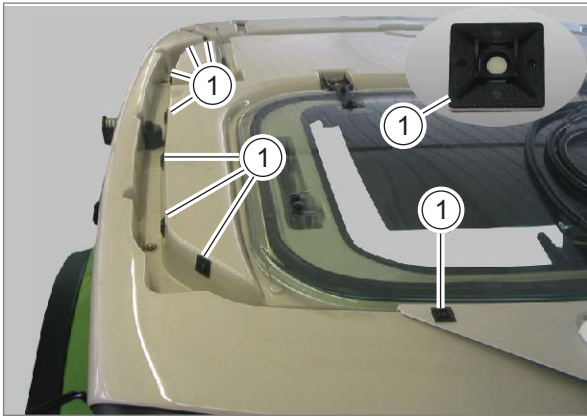

136441-001

164

1		-
---	--	---

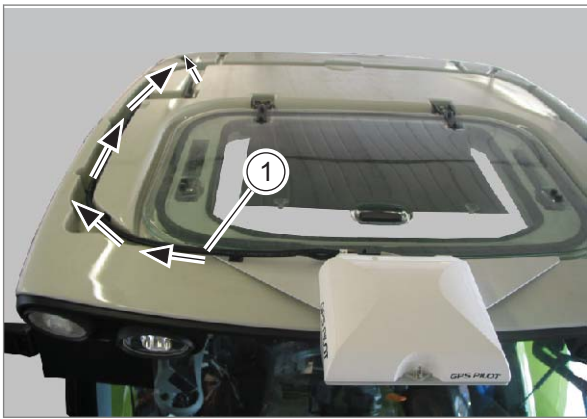

136443-001

165

1		00 1401 007 1
2		-

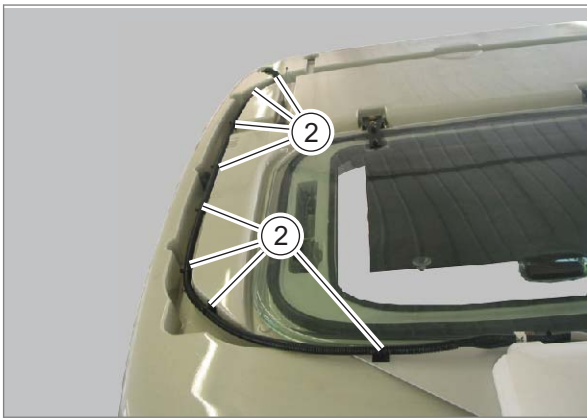

136442-001

166

1		00 1401 007 1
2		-

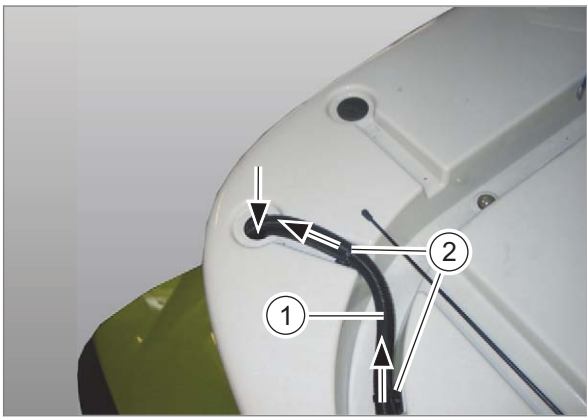

136466-002

167

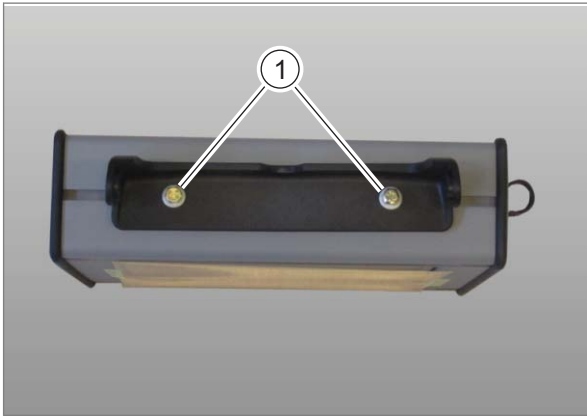

141032-001

1		M5x8 (2x) A5 (2x)
---	--	----------------------

195



141033-001

1		-
---	--	---

196

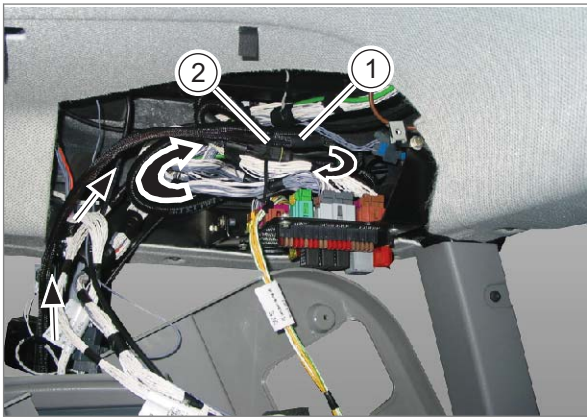

136549-001

1	 	00 1401 005 2 00 1400 148 0 00 1401 007 1
2		-

197

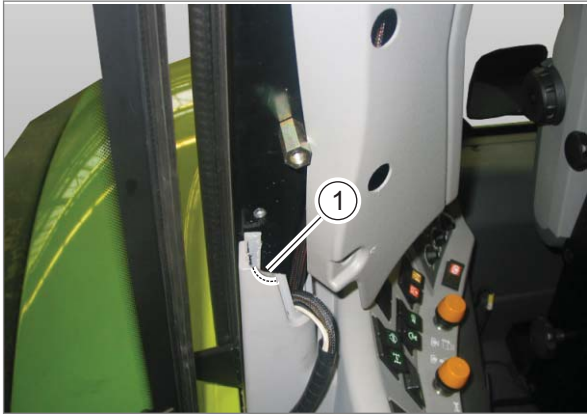

138112-001

1		-
---	--	---

217



140442-001

1		-
---	--	---

218

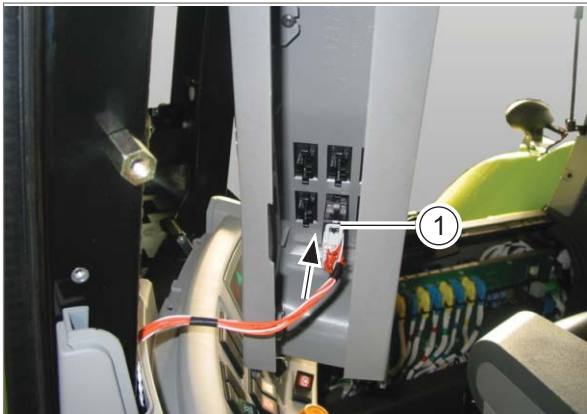

140440-001

219

CLICK HERE TO **DOWNLOAD** THE COMPLETE MANUAL

- Thank you very much for reading the preview of the manual.
- You can download the complete manual from: www.heydownloads.com by clicking the link below



- Please note: If there is no response to CLICKING the link, please download this PDF first and then click on it.

CLICK HERE TO **DOWNLOAD** THE COMPLETE MANUAL