

LTM 1160/2

HUBWERK 1

EURO II - MOTOR

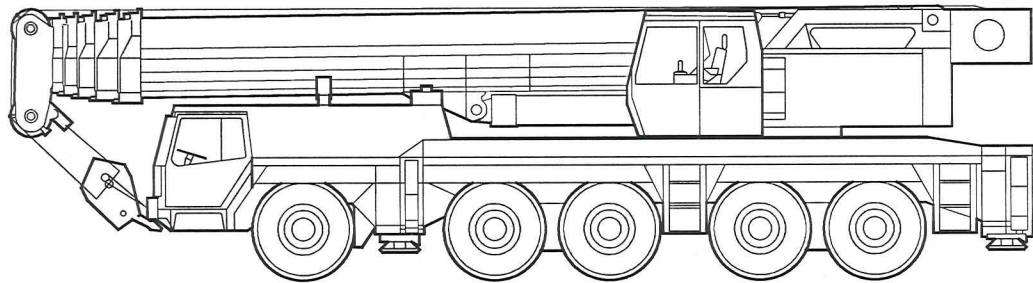

0			
9			
8			
7			
6			
5			
4			
3			

2	93060	06.07.98	eie	Gez.	12.03.97	eie	LIEBHERR WERK EHINGEN	SCHALTPLAN DREHBÜHNE	Ident-Nr.	982755008	=	S20
1	92844	26.05.98	eie	Ausgabe	22.01.03	dpl			Zeich-Nr.	3360-932.11.00.001-002	Blatt	1
	Anderung	Datum	Name		Datum	Name	Copyright (c)				von	131

CLICK HERE TO **DOWNLOAD** THE COMPLETE MANUAL

- Thank you very much for reading the preview of the manual.
- You can download the complete manual from: www.heydownloads.com by clicking the link below



- Please note: If there is no response to CLICKING the link, please download this PDF first and then click on it.

CLICK HERE TO **DOWNLOAD** THE COMPLETE MANUAL

ZE 1		WIPPEN														NOT-BETRIEB				
		BETRIEBSART														T/TF				
POS	KLEMME	SYMBOL	BEZEICHNUNG	X ¹	X ²															BEMERKUNG
	C0.8.1		LMB FREI	X ¹	X ²															
	C0.8.2		OGWT FREI	X																
	C0.8.3		UGWT FREI		X ²															
	C0.11.1		ORWT ARBEITSWINKEL UNTEN		X ³															
	C0.11.0		ORWT ARBEITSWINKEL OBEN	X ³																
	E1.0 /51.2		HUBENSCHALTER AUSLEGER FREI		X ²															
	E1.1 /51.5		HUBENSCHALTER ZUBEHÖR FREI		X ²															
			DATE / GEPRÜFT																	
ÜBERBRÜCKUNG MIT :			X ¹ =	X ² =	X ³ =															

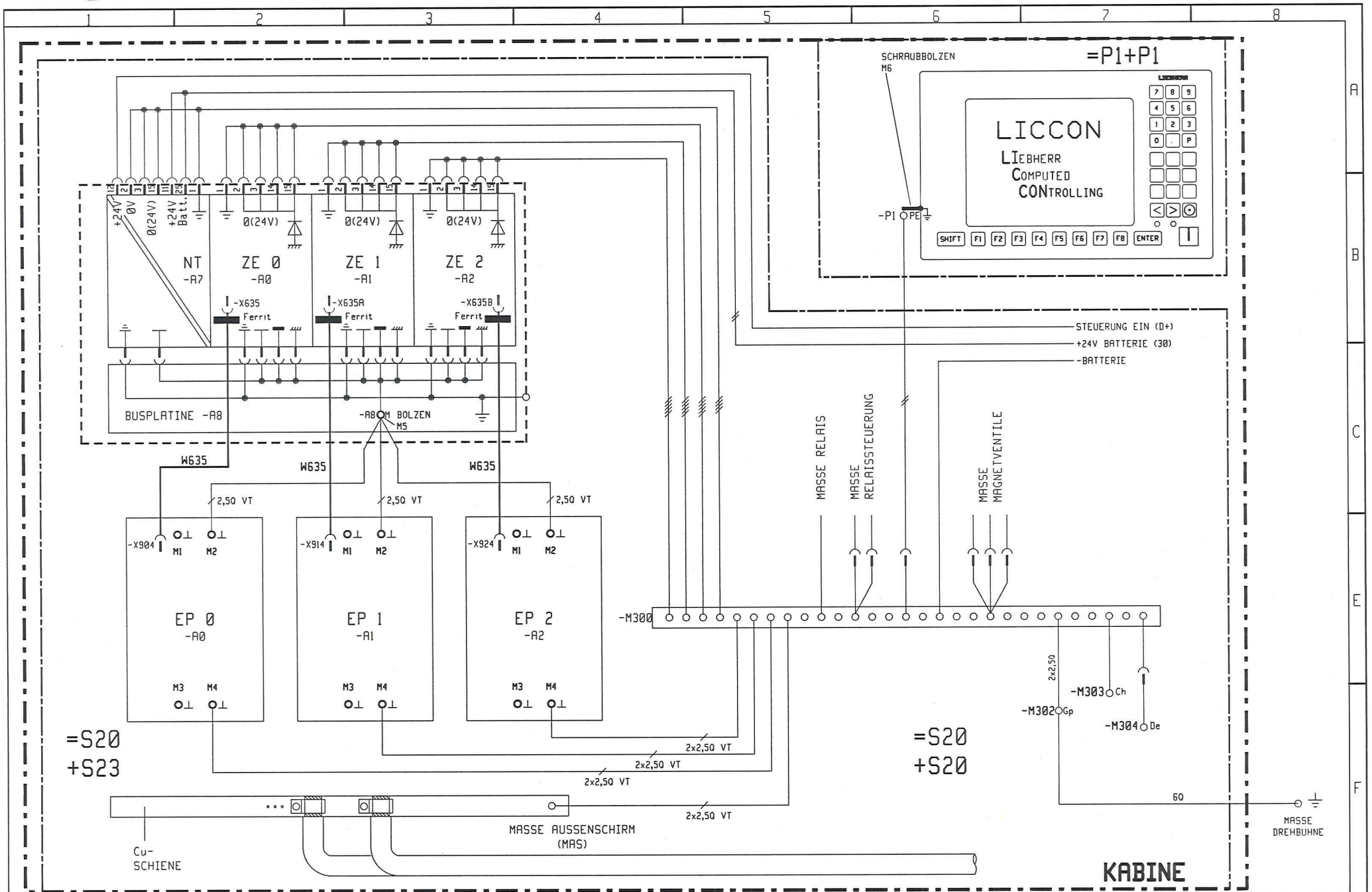

3			Gez.	12.03.97	eie	LIEBHERR WERK EHINGEN	MASSEFÜHRUNG	Ident-Nr.	982755008	=	S20
2			Ausgabe	22.01.03	dpl					+	S20
1										Zeich-Nr.	3360-932.11.00.001-002
	Anderung	Datum	Name	Datum	Name	Copyright (c)				von	131

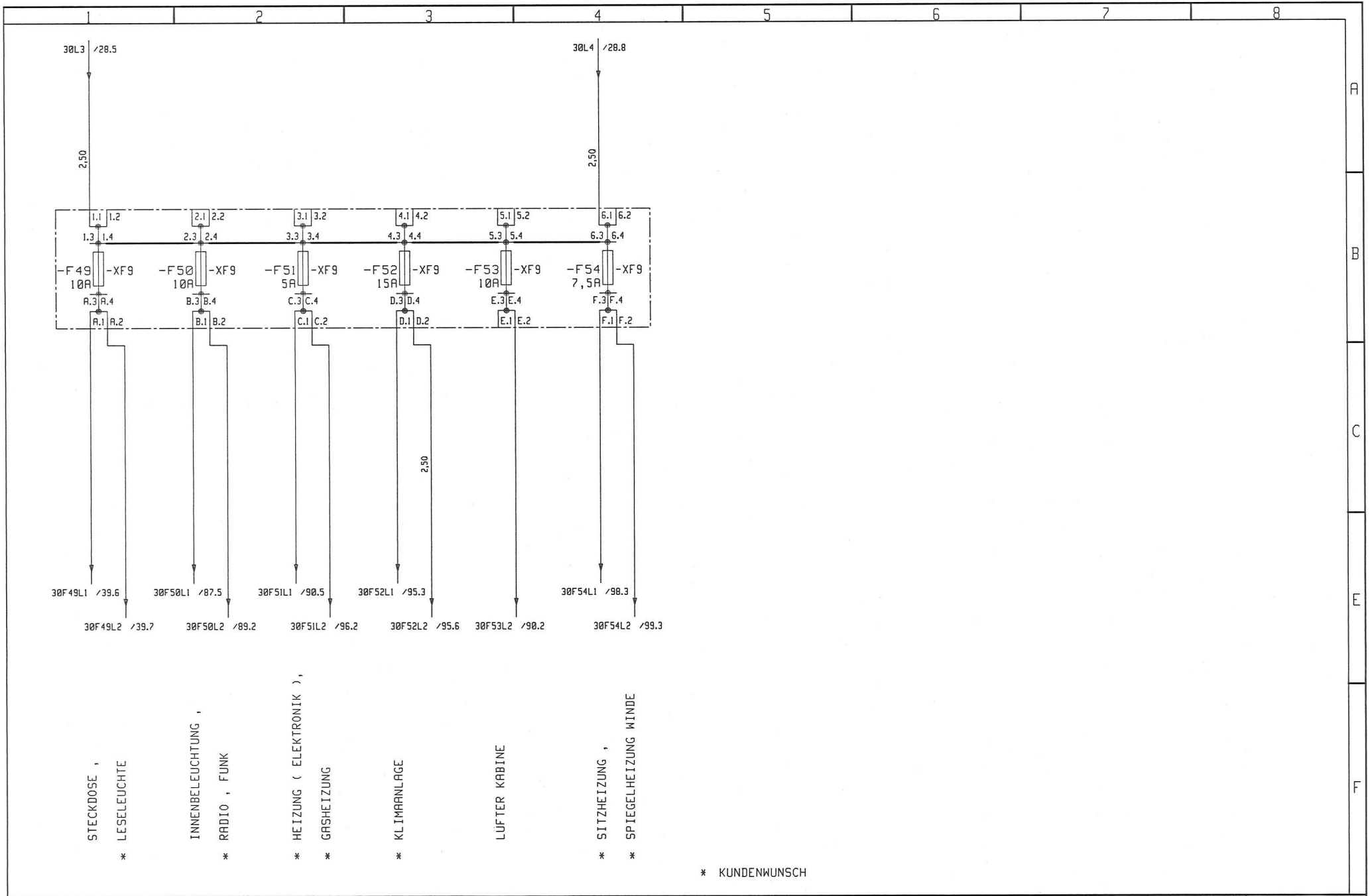

3			Gez.	12.03.97	eie	LIEBHERR WERK EHINGEN	SPANNUNGSVERSORGUNG , SICHERUNGEN	Ident-Nr.	982755008	=	S20
2			Rausgabe	22.01.03	dpl			Zeich-Nr.	3360-932.11.00.001-002	+	S20
1	Anderung	Datum	Name	Datum	Name			Copyright (c)		Blatt	31

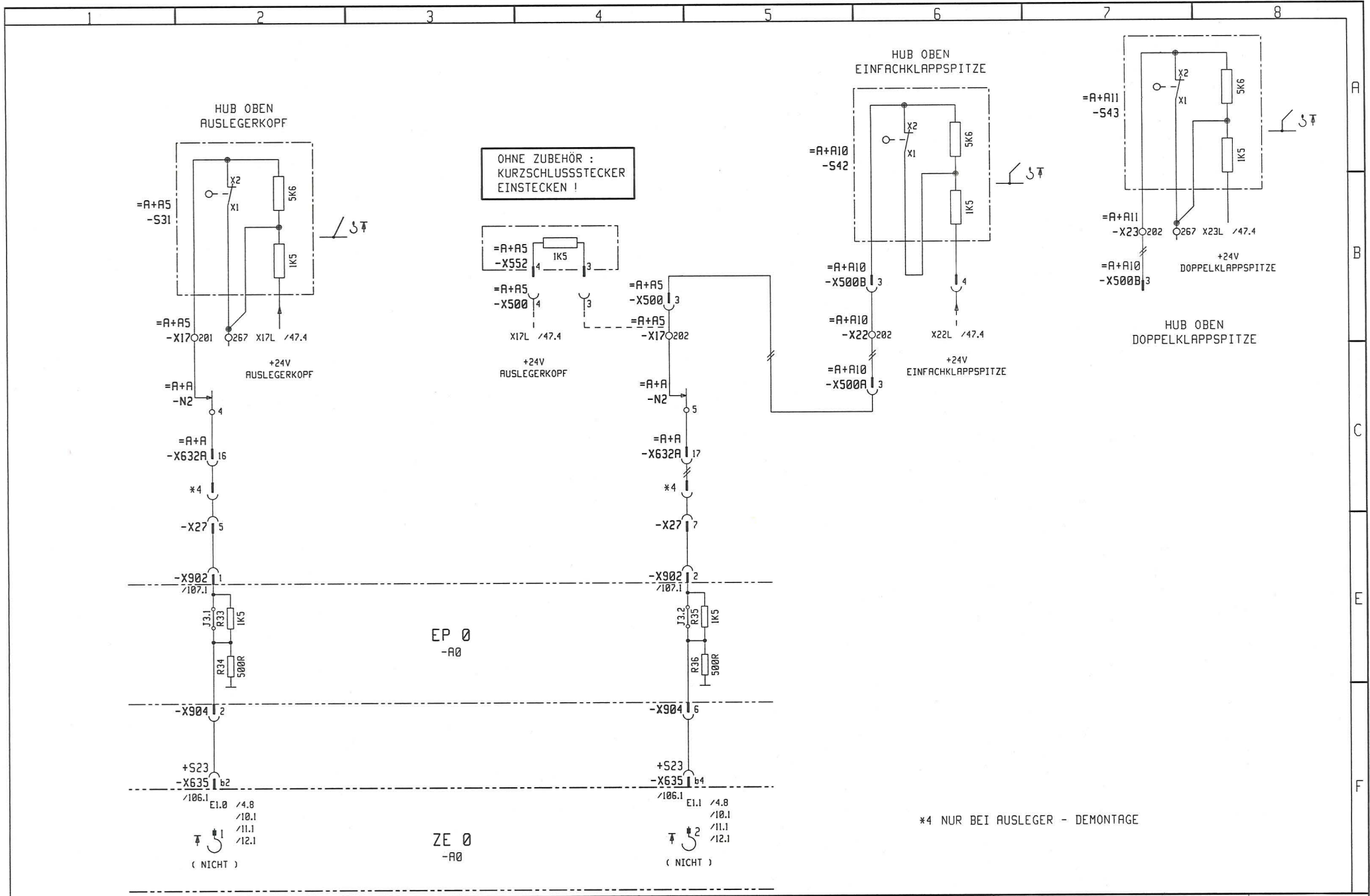

3			Gez.	12.03.97	eie	LIEBHERR WERK EHINGEN	HUB OBEN	Ident-Nr.	982755008	=	S20
2			Ausgabe	22.01.03	dpl					+	S20
1										Zeich-Nr.	3360-932.11.00.001-002
	Änderung	Datum	Name	Datum	Name	Copyright (c)				von	131

CLICK HERE TO **DOWNLOAD** THE COMPLETE MANUAL

- Thank you very much for reading the preview of the manual.
- You can download the complete manual from: www.heydownloads.com by clicking the link below



- Please note: If there is no response to CLICKING the link, please download this PDF first and then click on it.

CLICK HERE TO **DOWNLOAD** THE COMPLETE MANUAL

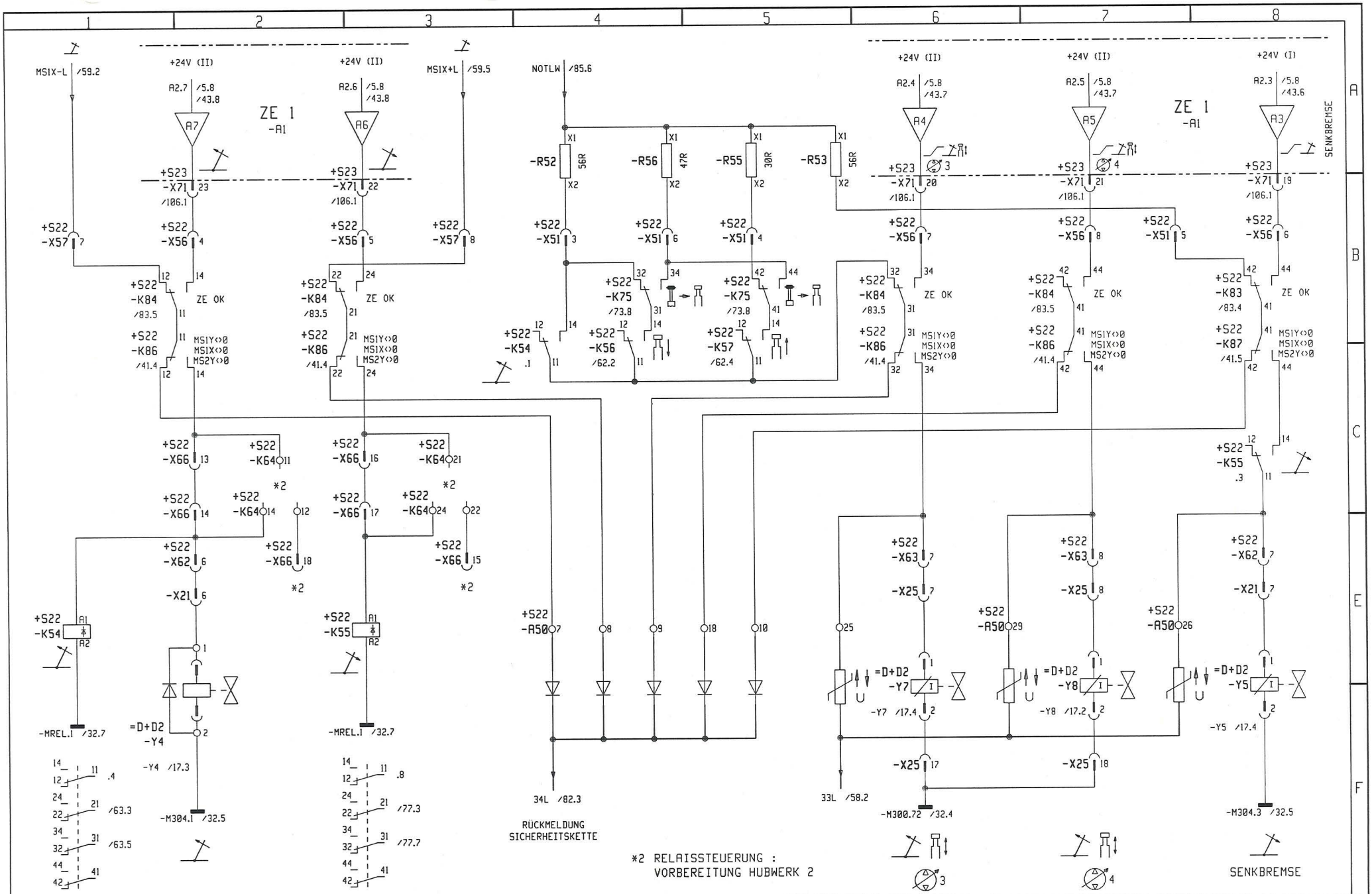

3			Gez.	12.03.97	eie	LIEBHERR WERK EHINGEN	WIPPEN , PUMPE 3 + 4	Ident-Nr. 982755008	=	S20
2			Ausgabe	22.01.03	dpl				+ S20	
1									Blatt 61	
Änderung			Datum	Name	Datum	Name	Copyright (c)	Zeich-Nr. 3360-932.11.00.001-002	von	131

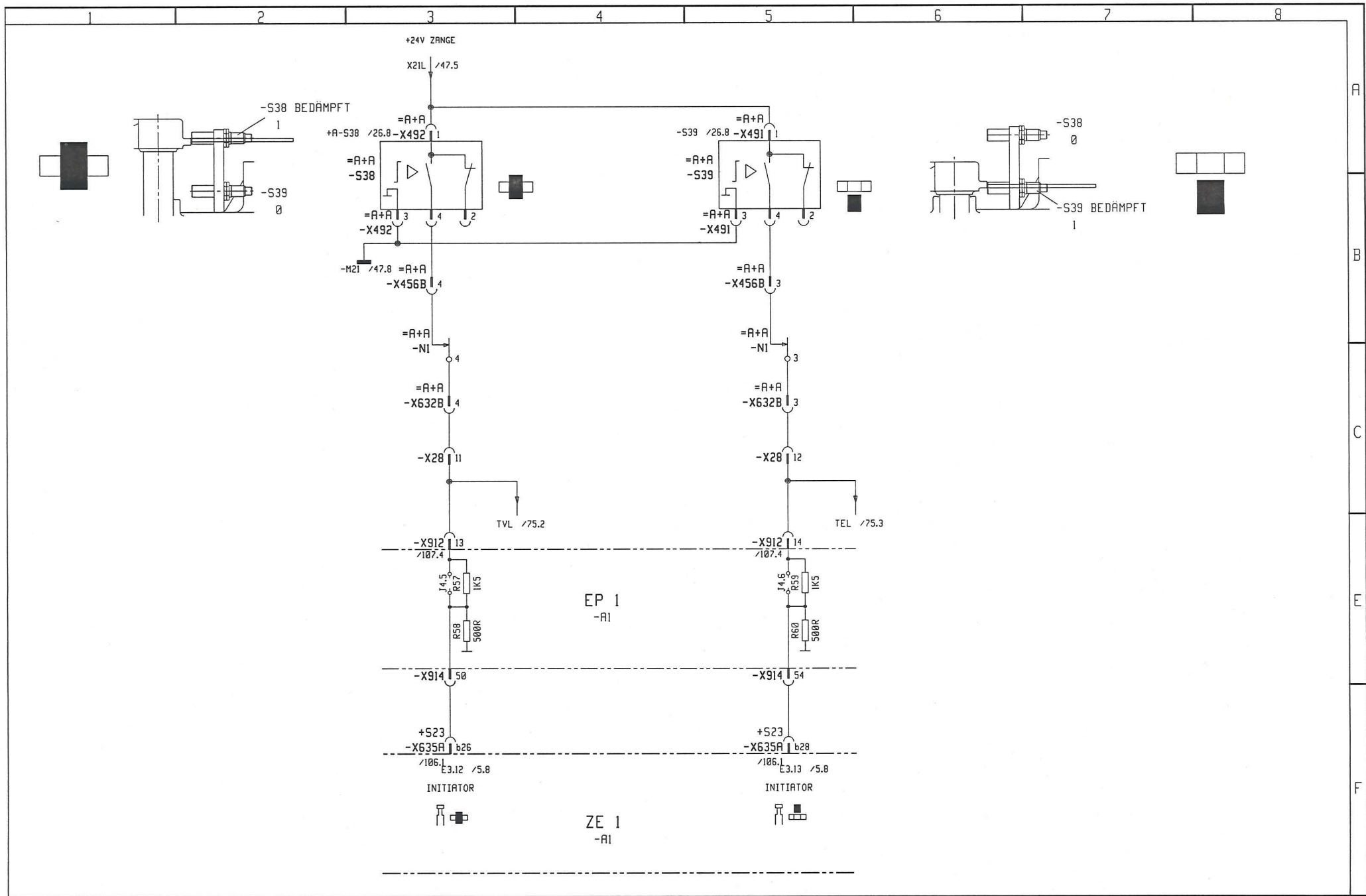

3			Gez.	13.03.98	eie	LIEBHERR WERK EHINGEN	TELE VERBOLZT / ENTBOLZT	Ident-Nr.	982755008	=	S20
2			Rausgabe	22.01.03	dpl					+	S20
1			Anderung	Datum	Name					Blatt	71
							Copyright (c)	Zeich-Nr.	3360-932.11.00.001-002	von	131

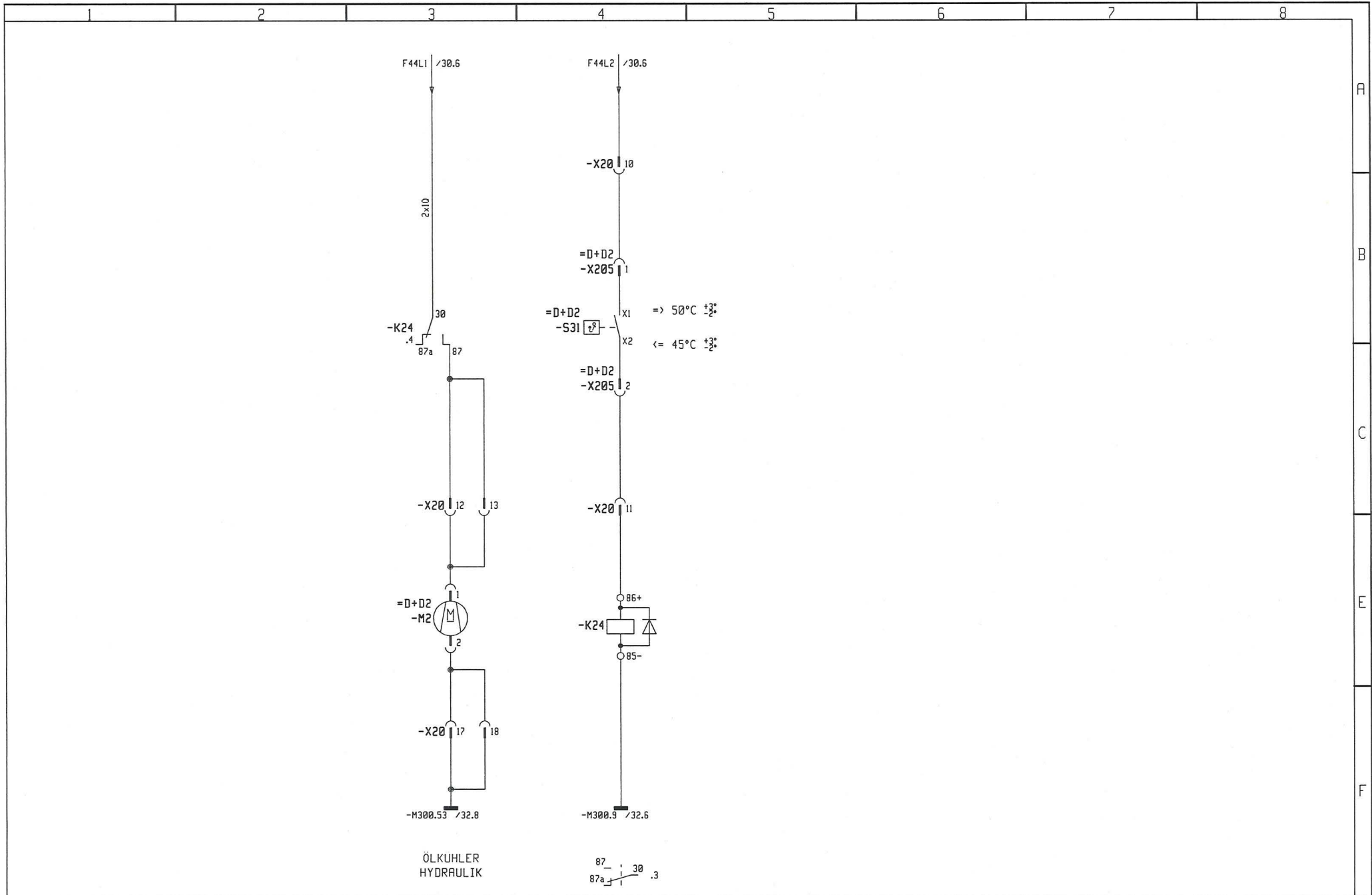

ÖLKÜHLER
HYDRAULIK

87_ : 30 .3
87a_ |

3			Gez.	12.03.97	eie	LIEBHERR WERK EHINGEN	ÖLKÜHLER	Ident-Nr.	982755008	=	S20
2			Ausgabe	22.01.03	dpl					+	S20
1										Blatt	81
	Anderung	Datum	Name	Datum	Name	Copyright (c)		Zeich-Nr.	3360-932.11.00.001-002	von	131

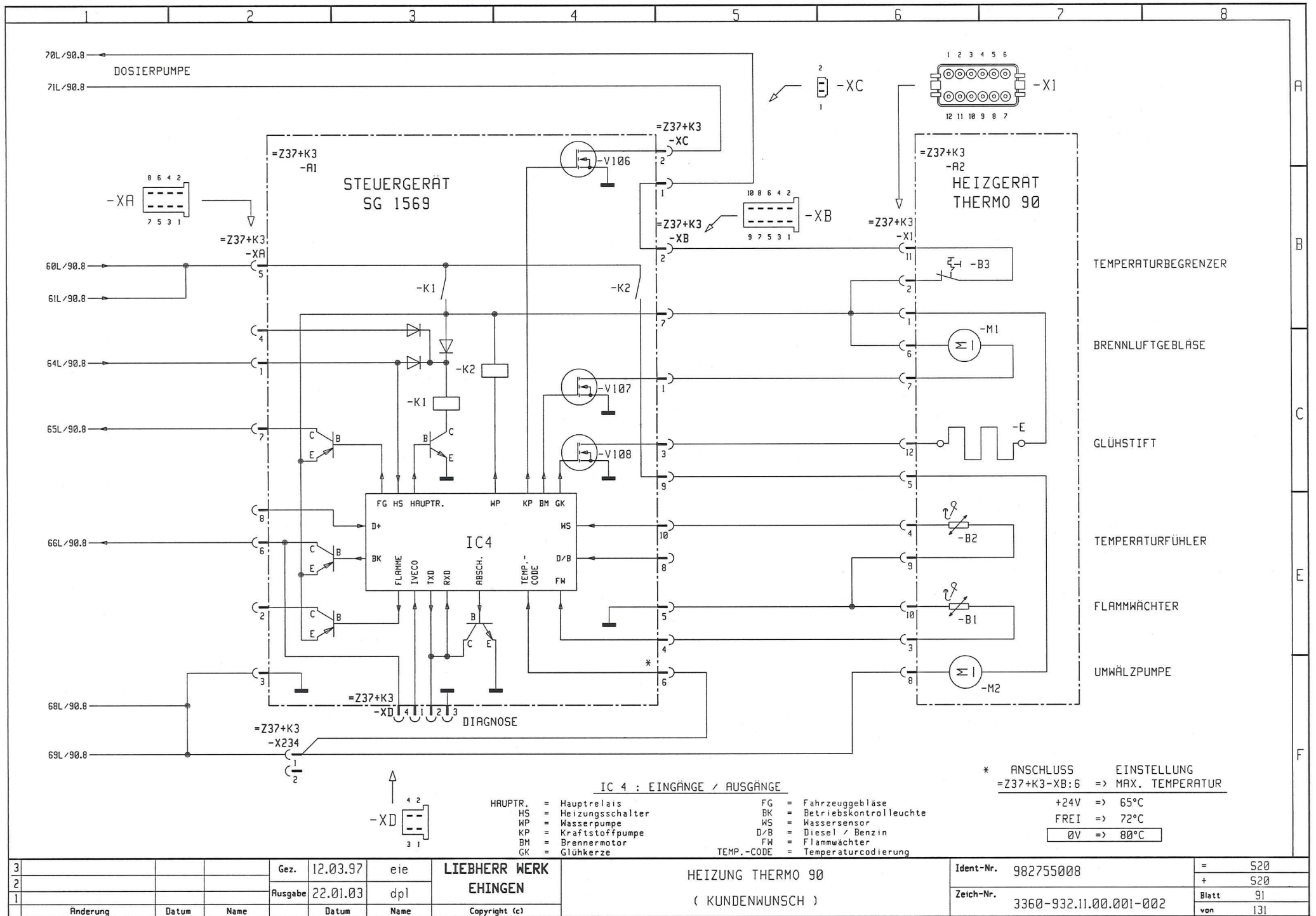

3			Gez.	12.03.97	eie
2			Ausgabe	22.01.03	dpl
1					
	Anderung	Datum	Name	Datum	Name







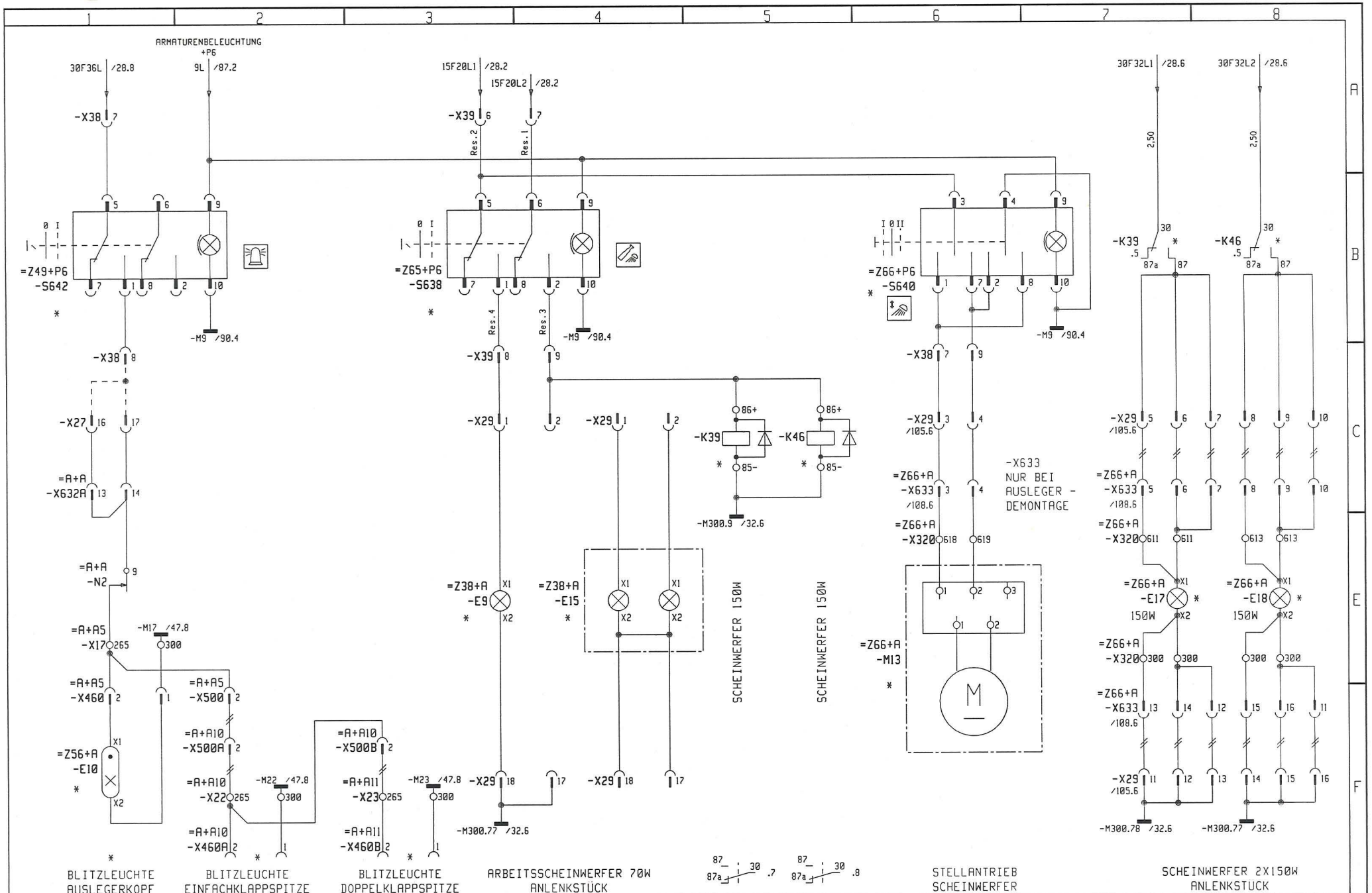





















**LIEBHERR WERK
EHINGEN**
Copyright (c)

HEIZUNG THERMO 90
(KUNDENWUNSCH)

Ident-Nr. 982755008
= S20
+ S20
Zeich-Nr. 3360-932.11.00.001-002
Blatt 91
von 131



3			Gez.	12.03.97	eie	LIEBHERR WERK EHINGEN	BLITZLEUCHE AUSLEGER (KUNDENWUNSCH) , ARBEITSSCHEINWERFER AUSLEGER (KUNDENWUNSCH)	Ident-Nr.	982755008	=	520
2			Ausgabe	22.01.03	dpl			Zeich-Nr.	3360-932.11.00.001-002	+	520
1			Anderung							Blatt	101
						Copyright (c)				von	131

1	2	3	4	5	6	7	8
	HEBEN , AUSFAHREN , AUF		TELE		PUMPE		
	SENKEN , EINFAHREN , AB		ABWIPPEN		NÄHERUNGSSCHALTER		
	FREI , FÄHRT		AUFWIPPEN		MONTAGE		
	VORWÄRTS , RECHTS		HAUPTAUSLEGER WIPPEN		HORN		
	RÜCKWÄRTS , LINKS		HAUPTAUSLEGER		SCHNELLGANG		
	BEGRENZUNG NACH OBEN		KLAPPSPITZE , GITTERSPITZE	LMB	LASTMOMENTBEGRENZUNG		
	BEGRENZUNG NACH UNTEN		DREHEN LINKS	Red.	REDUZIERUNG		
	ANALOG		DREHEN RECHTS	MS	MEISTERSCHALTER		
	DIGITAL		DREHEN , DREHWERK	MS<>0	NULLAGE MEISTERSCHALTER (NICHT)		
	WINKEL		DREHWERK RUNDLAUF	T	TELEAUSLEGER		
	SCHALTLOGIK		HUBWERK , WINDE ...	F	GITTERSPITZE (FEST) , KLAPPSPITZE		
	DURCH DRUCK BETÄTIGT		HAKEN ...	N	WIPPSPITZE , NADEL		

3			Gez.	12.03.97	gie	LIEBHERR WERK EHINGEN	SYMBOLERKLÄRUNG	Ident-Nr.	982755008	=	520
2			Ausgabe	22.01.03	dpl			Zeich-Nr.	3360-932.11.00.001-002	+	520
1								Blatt	111	von	131
	Anderung	Datum	Name	Datum	Name	Copyright (c)					

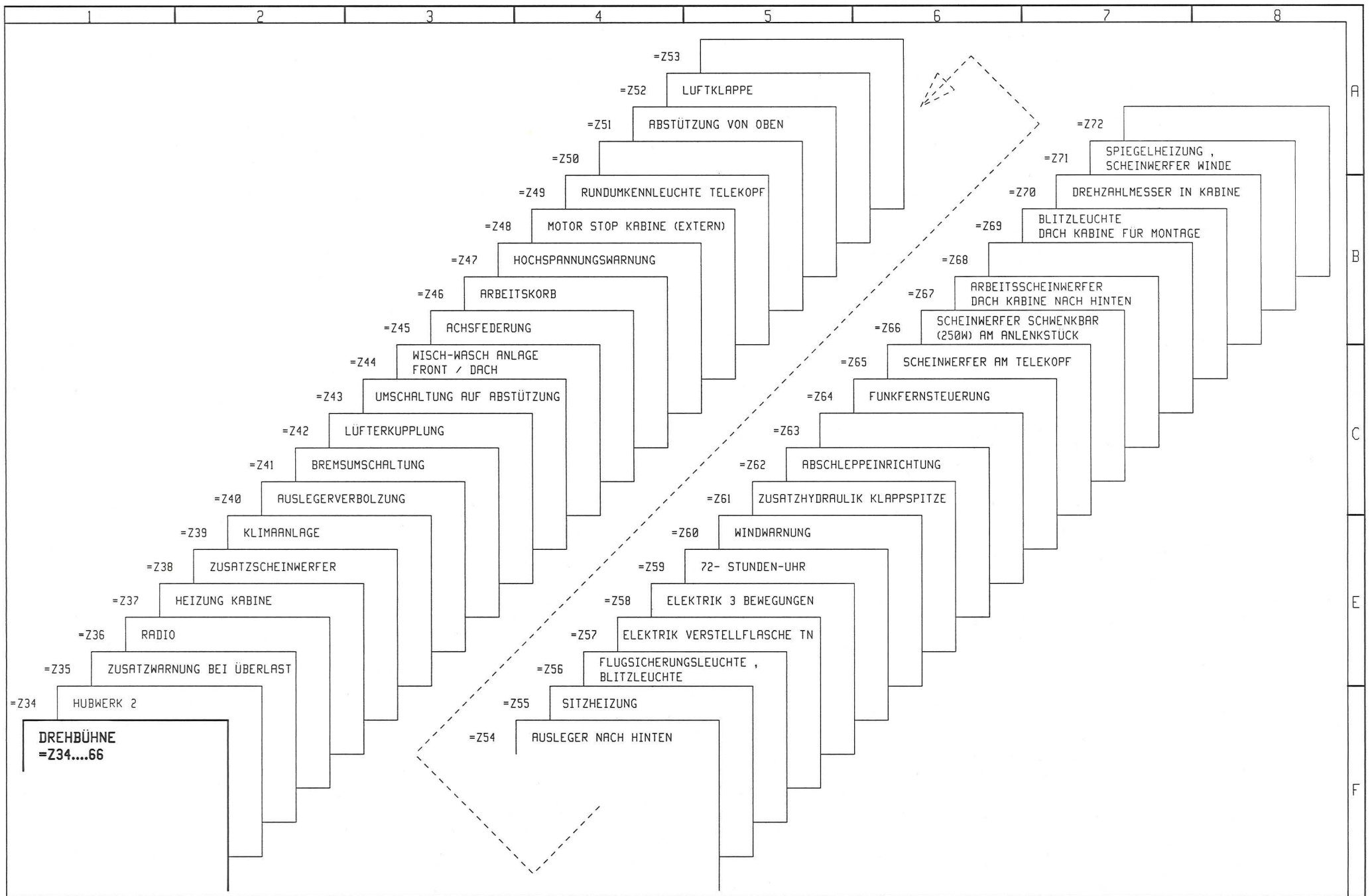

3			Gez.	12.03.97	eie	LIEBHERR WERK EHINGEN	BAUGRUPPENÜBERSICHT SONDERAUSRÜSTUNG	Ident-Nr.	982755008	=	S20
2			Rausgabe	22.01.03	dpl			+ S20			
1			Anderung	Datum	Name			Blatt	121		
				Datum	Name	Copyright (c)		von	131		

CLICK HERE TO **DOWNLOAD** THE COMPLETE MANUAL

- Thank you very much for reading the preview of the manual.
- You can download the complete manual from: www.heydownloads.com by clicking the link below



- Please note: If there is no response to CLICKING the link, please download this PDF first and then click on it.

CLICK HERE TO **DOWNLOAD** THE COMPLETE MANUAL