

CLAAS

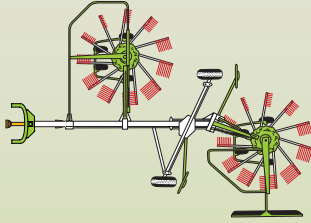

LINER 1550 Profil

Zusammenbauanleitung

Assembly instructions

Instruction de montage

Istruzioni di montaggio

Instrucciones de Monaje

Montage van de machine

Monteringsvejledning

SERVICE & PARTS

CLICK HERE TO **DOWNLOAD** THE COMPLETE MANUAL











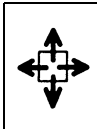

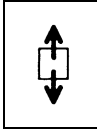

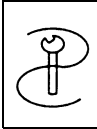
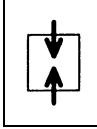
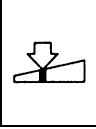
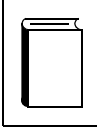
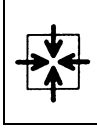
- Thank you very much for reading the preview of the manual.
- You can download the complete manual from: www.heydownloads.com by clicking the link below

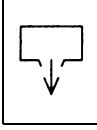
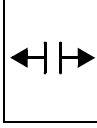
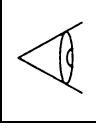
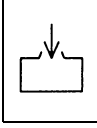
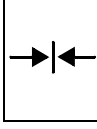

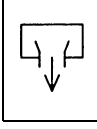
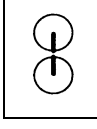
- Please note: If there is no response to CLICKING the link, please download this PDF first and then click on it.

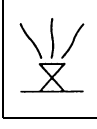
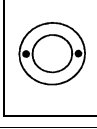
CLICK HERE TO **DOWNLOAD** THE COMPLETE MANUAL

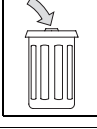
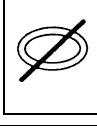
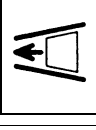
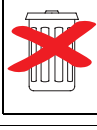
BILDZEICHEN

	Abbauen Ausbauen		Einfetten		Materialschaden ver- hüten
	Zerlegen		Einölen		Spezialwerkzeug verwenden
	Zusammenbauen		Einstellen		Betriebsanleitung, Technische Daten beachten
	Einbauen Anbauen		Achtung		Ablassen Ablassöffnung
	Lösen (z. B. Spanneinrichtun- gen)		Auge, kontrollieren prüfen		Einfüllen Einfüllöffnung
	Spannen (z. B. Spanneinrichtun- gen)		Entsichern, Sichern		Überlauf
	Markieren		Flüssig sichern, Kle- ben Dichten		Entlüften
	Wuchten		Unterbauen Abstützen Abfangen		Teile umweltgerecht entsorgen
	Bedingt wiederver- wendbar		Einbaurichtung beach- ten		Teile für spätere Wie- derverwendung aufbe- wahren
	Bei jeder Montage auswechseln		Gewicht der Bauteile beachten		

4 Assembly instructions

GENERAL INSTRUCTIONS FOR ASSEMBLY



Danger!

Always work on the machine/front attachment with the engine switched off.

- Remove the ignition key!
-

Symbols are used to describe the activity or operation. For a description of the symbols see section »*Symbols*« on page 4.3. The standard parts are also described by unique symbols.

Text and pictures are kept as neutral as possible. Text notes call attention to differences in the specific types.

ASSEMBLY OF THE SWATHER

The description of the assembly is language-neutral. See Chapter 5. Work sequence for the description.

Follow the pictorial instructions for assembly exactly.

Follow the work sequence.



Danger!

Danger of accident when lifting heavy parts from the packaging and during assembly.

- Note the weights of the parts!
 - Use safe lifting equipment!
 - Observe accident prevention regulations!
-

Carry out assembly following the illustrations in Chapter 5. Work sequence.

3 Conseils généraux

IMPORTANT

Afin d'éviter les accidents, ce manuel et surtout les remarques, doivent être lus par toutes les personnes qui utilisent la machine/ l'appareil frontal, qui s'occupent de la maintenance, de l'entretien et du contrôle. Il convient en particulier de porter une attention soutenue au chapitre «Conseils généraux» et au chapitre «sécurité» dans votre notice. Veuillez respecter les consignes de prévention des accidents en vigueur dans votre pays.

Avant de commencer le travail, vérifiez d'abord que tous les outils et moyens nécessaires sont au complet. Comparez le type de machine/ d'appareil frontal avec le kit des pièces fournies.

Les textes et les tableaux sont établis neutres autant que possible. Les différences entre les modèles sont mises en évidence par des renvois dans le texte.

Les caractéristiques techniques, dimensions et poids sont indiqués avec les tolérances usuelles.

Les côtés avant, arrière, droit et gauche s'entendent toujours dans le sens de marche.

IDENTIFICATION DES PRESCRIPTIONS CONCERNANT LES AVERTISSEMENTS ET LES DANGERS

Dans la présente notice d'utilisation, les passages concernant votre sécurité ainsi que celle de la machine/ de l'appareil frontal sont mis en relief à l'aide des symboles ci-dessous. Prière de mettre ces consignes de sécurité à la disposition de tout autre utilisateur.



Danger !

Identification de prescriptions dont le non-respect peut entraîner des dommages corporels ou la mort de l'utilisateur ou de tiers.

- Mesures pour éviter le danger.



Attention !

Identification des prescriptions dont le non-respect peut entraîner des risques pour la machine/l'appareil frontal.

- Mesures pour éviter de mettre la machine/l'appareil frontal en danger.



Important !

Identification des prescriptions permettant un emploi plus efficace et plus rentable de la machine/l'appareil frontal.



Observer !

Identification des prescriptions devant être observées lors de la dépose/l'installation.



Environnement !

Identification des prescriptions dont le non-respect entraîne des risques écologiques.

Il existe un danger écologique lorsque les produits constituant un danger écologique (par ex. huile de vidange) ne sont pas manipulés et/ou éliminés conformément aux prescriptions.

1 Introduzione

INTRODUZIONE

Le presenti istruzioni descrivono la procedura di lavoro sicura e veloce per eseguire il montaggio della macchina.

Leggere quindi attentamente queste istruzioni prima di cominciare il lavoro! Osservare specialmente il paragrafo »**Indicazioni generali**« e le indicazioni di pericolo nel libretto d'uso.

Si possono montare le seguenti macchine:

Andatore:

LINER 1550 Profil

CLAAS Servizio assistenza clienti

ES

Instrucciones de montaje

CLAAS KGaA mbH trabaja siempre en la mejora de sus productos a fin de evolucionar técnicamente. Por ello nos reservamos el derecho de realizar modificaciones en las figuras y descripciones de este manual de instrucciones sin que por ello se nos puedan exigir cambios en las máquinas que ya han sido entregadas.



Los datos técnicos, medidas y pesos han de entenderse con las correspondientes tolerancias.

Reimpresión o traducción, incluso parcial, autorizada sólo con permiso por escrito de CLAAS KGaA mbH.

Reservados todos los derechos sobre la propiedad intelectual.

CLAAS KGaA mbH
33426 HARSEWINKEL
Germany

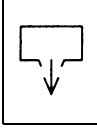
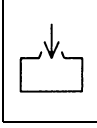
SYMBOLLEN

	afbreken uitbouwen		invetten		materiaalschade voor- komen
	demonteren		inoliën		speciaal gereedschapgebruike n
	monteren		instellen		goed nota nemen van gebruiksaanwijzing, Technische gegevens
	inbouwen aanbouwen		Let op!		aftappen aftapopening
	losmaken (b.v. spaninrichtingen)		oog, controleren inspecteren		vullen vulopening
	spannen (b.v. spaninrichtingen)		ontgrendelen, vergren- delen		overloop
	markeren		vloeibaar borgen, lij- men afdichten		ontluchten
	uitbalanceren		steunen stutten ondersteunen		delen op ecologisch verantwoorde wijze afvoeren
	beperkt herbruikbaar		letten op inbouwrich- ting		Onderdelen voor later hergebruik bewaren.
	Bij elke montage ver- vangen		Letten op gewicht van onderdelen		

4 Monteringsanvisninger

GENERELLE ANVISNINGER VEDR. MONTERING



Fare!

Der må kun arbejdes på maskinen/redskabet med slukket motor.

- Tag tændingsnøglen ud!

Til beskrivelse af aktiviteter resp. handlinger anvendes billedsymboler. Beskrivelsen af billedsymbolerne finder du i afsnittet »Symboler« på side 4.3. Standarddelene er desuden beskrevet ved hjælp af entydige symboler.

Tekster og billeder er så vidt muligt holdt neutrale. Der gøres opmærksom på forskelle mellem de enkelte typer vha. teksthenviisninger.

MONTERING AF ROTORRIVEN

Beskrivelsen af monteringen er holdt sprogneutralt. Beskrivelsen finder du i kapitel 5. Arbejdsforløb.

Følg billederne nøje for at montere rotorreven.

Overhold arbejdsrækkefølgen.



Fare!

Der er fare for uheld, når der løftes tunge dele ud af emballagen, samt ved monteringen.

- Vær opmærksom på vægtangivelserne på de enkelte dele!
- Anvend sikkert løftegrej!
- Overhold forskrifter vedr. forebyggelse af uheld!

Foretag monteringen iht. billederne i kap. 5. Arbejdsforløb.

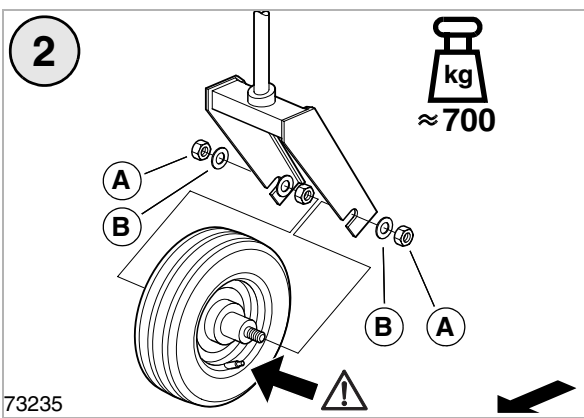
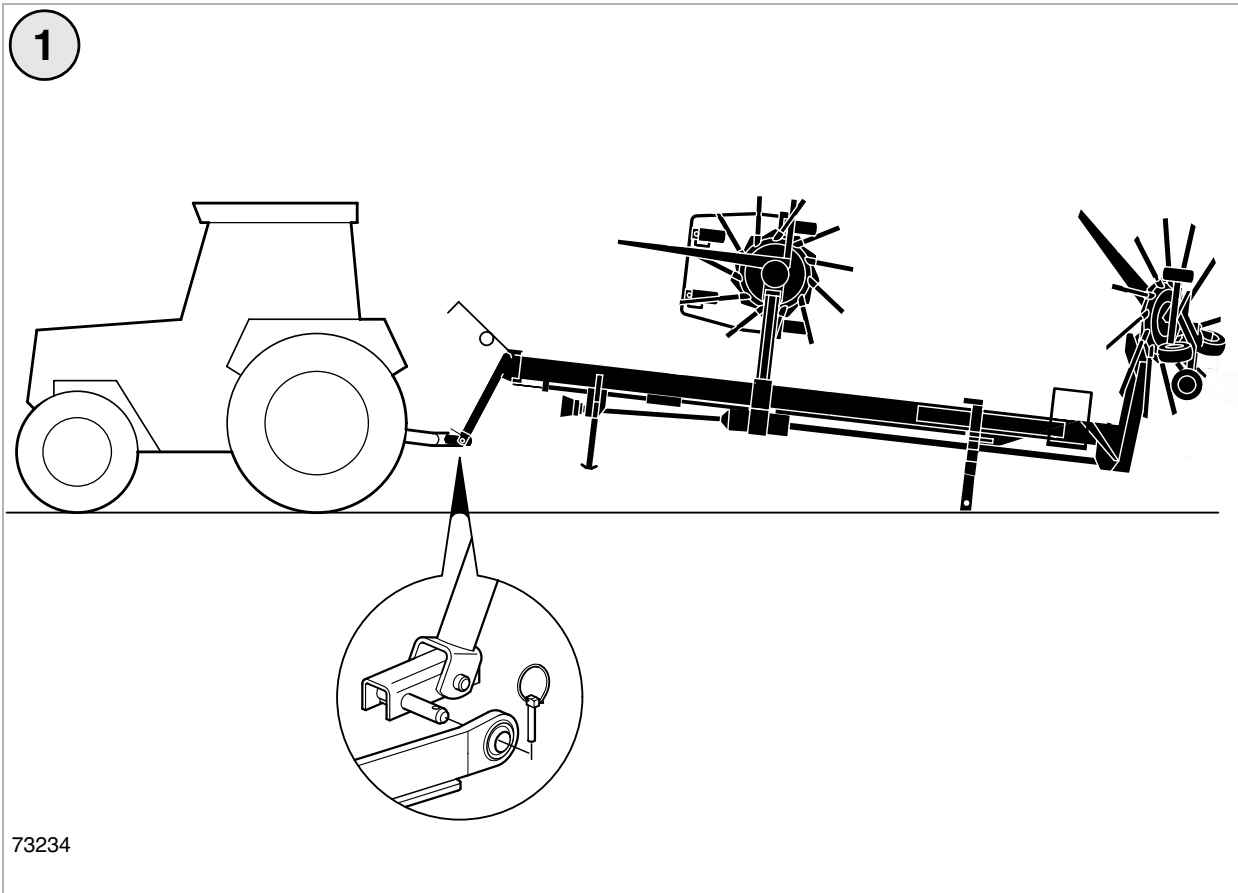

- A** 2x M24x2
- B** 2x ø 24

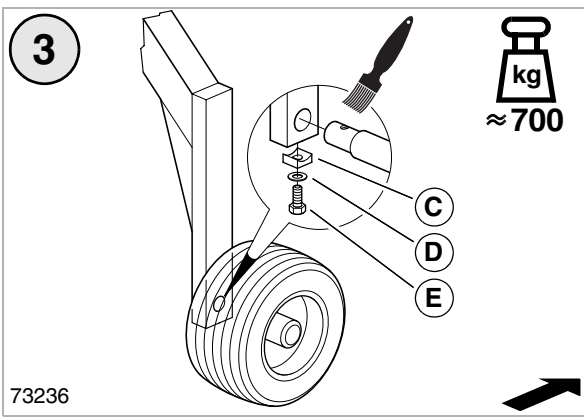

- C** 1x
- D** 1x A16
- E** 1x M16x45 MK

CLICK HERE TO **DOWNLOAD** THE COMPLETE MANUAL

- Thank you very much for reading the preview of the manual.
- You can download the complete manual from: www.heydownloads.com by clicking the link below



- Please note: If there is no response to CLICKING the link, please download this PDF first and then click on it.

CLICK HERE TO **DOWNLOAD** THE COMPLETE MANUAL